

be happy

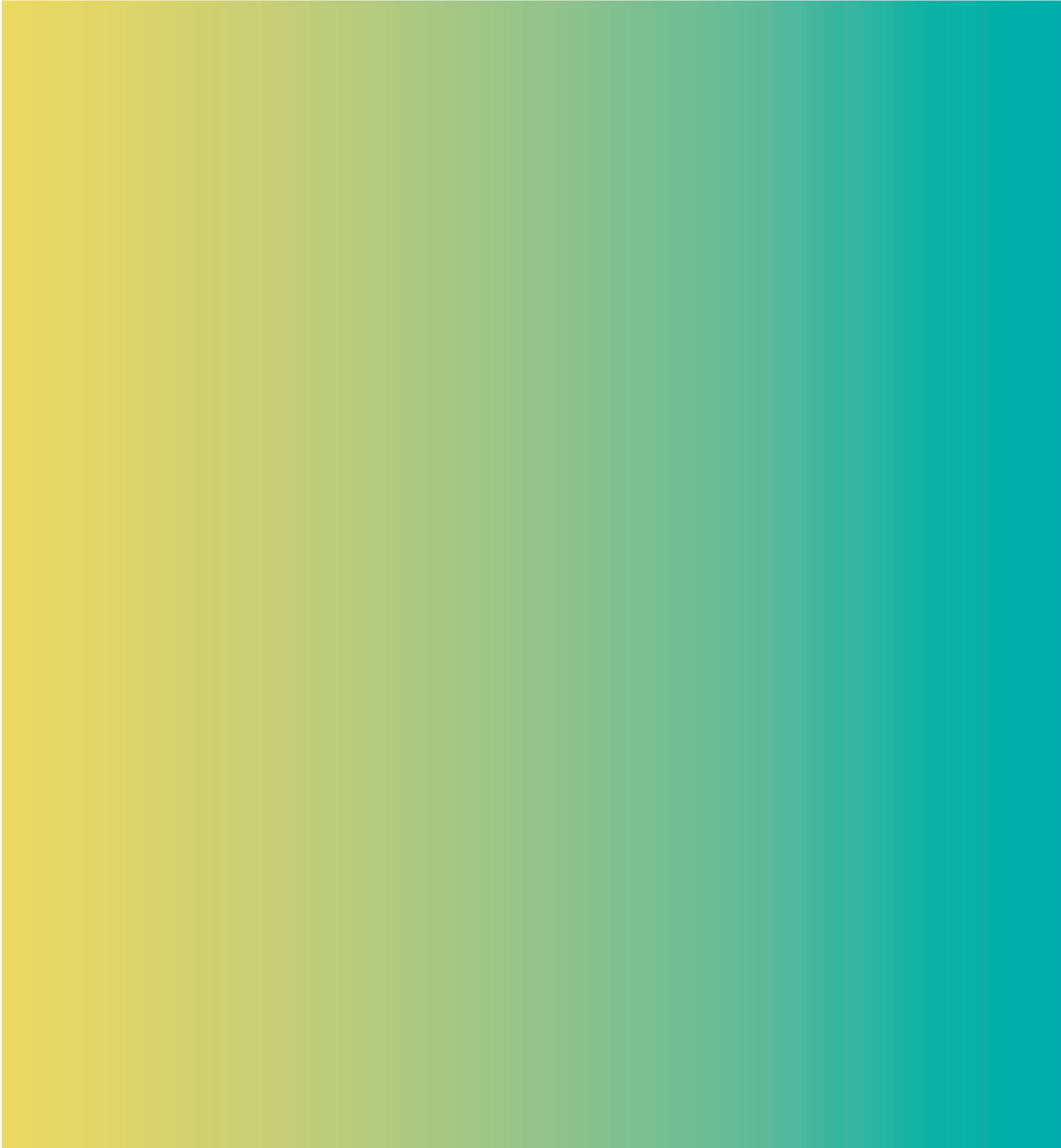



WE REDUCE

We are constantly working to further optimize all processes and resources so that our children inherit a better world.



WE REUSE

Our products are designed to withstand temperature limits and extreme weather elements. The long life of our products helps to reduce waste and makes way for more responsible consumption.



WE RECYCLE

Our design and development team have created the first collection of outdoor lamps made exclusively from recycled plastic from the seas and oceans (Greta P 92).

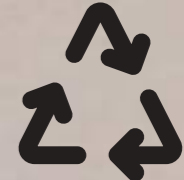

RECYCLABLE

All our products are recyclable. In addition, we work with specialised companies so that all our waste generated in our different processes is processed and recycled thoroughly.



passionate creators of

OUTDOOR & INDOOR MOMENTS



WE WANT
TO BE THE
LIGHT OF
YOUR BEST
MOMENTS



DESIGNERS & MANUFACTURERS OF MEMORIES

O F M E M O R I E S



PROUD
MAKERS
OF
"BE HAPPY"
SPIRIT



Sun is our energy.

The power of the sun is unimaginable. It is capable of generating life, inspiring our personality or changing our state of mind in seconds. At Newgarden we know about its power. That is why, since our beginnings, its energy has been the protagonist in our products. This is why we have ensured that the majority of our designs are available with a solar option.

Nature is our mother.

And we love her as if she were our mother. Newgarden works every day to improve all our processes in order to protect and care for our environment. We are not content with all of our products being recyclable: we have designed Greta, a collection of lamps made exclusively from recycled materials (P 92).



PASSIONATE ABOUT HANDMADE AND NATURAL FIBERS

Natural fibres such as hemp or bamboo are widely represented in our collection. Hand-made, they are able to transport us to nature and the Mediterranean just by looking at them.



THINK LOCAL

We collaborate with specialised local producers within their regions - this helps to grow their economies and support infrastructure development.



NATURE LOVERS

All our products are 100% recyclable and have a long life span, helping to reduce waste and promoting responsible consumption.



FRIENDS OF THE SEA

For every lamp in the Greta Collection (P 92) that we make, we help to give a second life to the plastic collected from the seas and oceans.

Light & Deco

NIZA	24	SISINE 30	60	CANDELA	84
AMALFI	26	BOSSA 30	63	NÓMADA	84
LOLA SLIM 120/180	28	CHLOE 35	62	FARALAY	85
CHLOE PLANT	30	ENOKI	64	KURBY	85
CHLOE 140	32	LOLA 20/30/45	65	NIPPER	86
ROCKET 70/145	34	LOLA SLIM 30	66	CUBY PLAY	86
FITY 100/160	36	CARMEN 45	68	CHERRY	87
HELGA	38	PANCHITO	69	PEPITA	88
PANCHO	40	ROCKET 20	69	PAQUITA	90
LOLA 110/165/200	42	STELLA	70	GRETA	92
CARMEN 110/165	44	AURORA	71	BALBY	94
FREDO 140/170	46	ALLEGRA	72	BULY HANG	94
KONIKA 170	48	SIMONA	74	PETRA HANG	94
GRACE 140/170	50	ILARIA	75	CLAUDY	94
BRUNA 80/165	52	CHIARA	76	SISINE WALL	95
GUFO	54	SAONA HANG	77	CUBY WALL	96
SAMBA	54	POSITANO	78	LOLA WALL	96
KAKTUS	55	BENIRRÁS	78	TERPE WALL	96
BALANS	56	BOSSA, SISINE, CALOBRA, REONA	80	BULY WALL	96
GOA	56	BITA	82	PAQUITA / PEPITA	97
SAONA 70	58	SORA	82	BULY FAMILY	98
SAONA 30	58	NORAI	82	PETRA	100
SISINE 70	60			CUBY FAMILY	101

Fur ni ture

RASA	104	CUBY	114	CRETA	121
FORMENTERA	106	BORA	115	PALMA BOTTLE RACH	122
NEW ISLAND	108	CALVIN & MELVIN	116	WOODY	123
SET TARIDA	110	BRICKY	117	CORFU & CAPRI 110	124
MALLORCA & CAPRI 75	112	SICILIA	118	PUFY & TAFY	126
MALLORCA & ITACA	113	IBIZA	120	CORFU 40 & CAPRI 40	127

Flo wer pots

OLIVO FAMILY	130	FICUS 60/80	140	NARCISO FAMILY	145
AZALEA FAMILY	132	BAMBU 70/90	141	CAMELIA FAMILY	146
HORTENSIA FAMILY	134	PALMERA	142	PALMA	148
MAGNOLIA FAMILY	136	JUNCO	143	GERBERA	150
MELISA FAMILY	138	JARA	144	VIOLETA	151

eternal PARADISE

1 - Bruna (+ info P 52)
2 - Tarida Sit Arms (+ info P 110)
3 - Tarida Tab (+ info P 110)

4 - Niza (+ info P 24)
5 - Aurora (+ info P 71)
6 - Sisine 30 (+ info P 60)



reinvented HOME



- 1 - Hortensia (+ info P 134)
- 2 - Goa (+ info P 56)
- 3 - Lola slim 180 (+ info P 28)
- 4 - Rasa (+ info P 104)
- 5 - Cuby (+ info P 101)
- 6 - Lola slim 30 (+ info P 66)
- 7 - Buly (+ info P 98)

MAGICAL MEDITERRANEAN

- 1 - Garlans (+ info P 70)
- 2 - Bossa Hang (+ info P 80)
- 3 - Sisine Hang (+ info P 80)
- 4 - Reona Hang (+ info P 80)
- 5 - Calobra Hang (+ info P 80)
- 6 - Sisine 30 (+ info P 60)
- 7 - Sisine 70 (+ info P 60)



Light & Deco



The NIZA lamp

Options

Light | Battery

+ Info P. 173

FLOOR LAMP & WALL LAMP
2 LAMPS in 1 LAMP

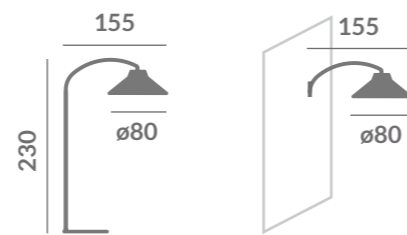

Niza



Light and Deco / Floor Lamps / Niza

Rechargeable Bulb
(Battery Version)

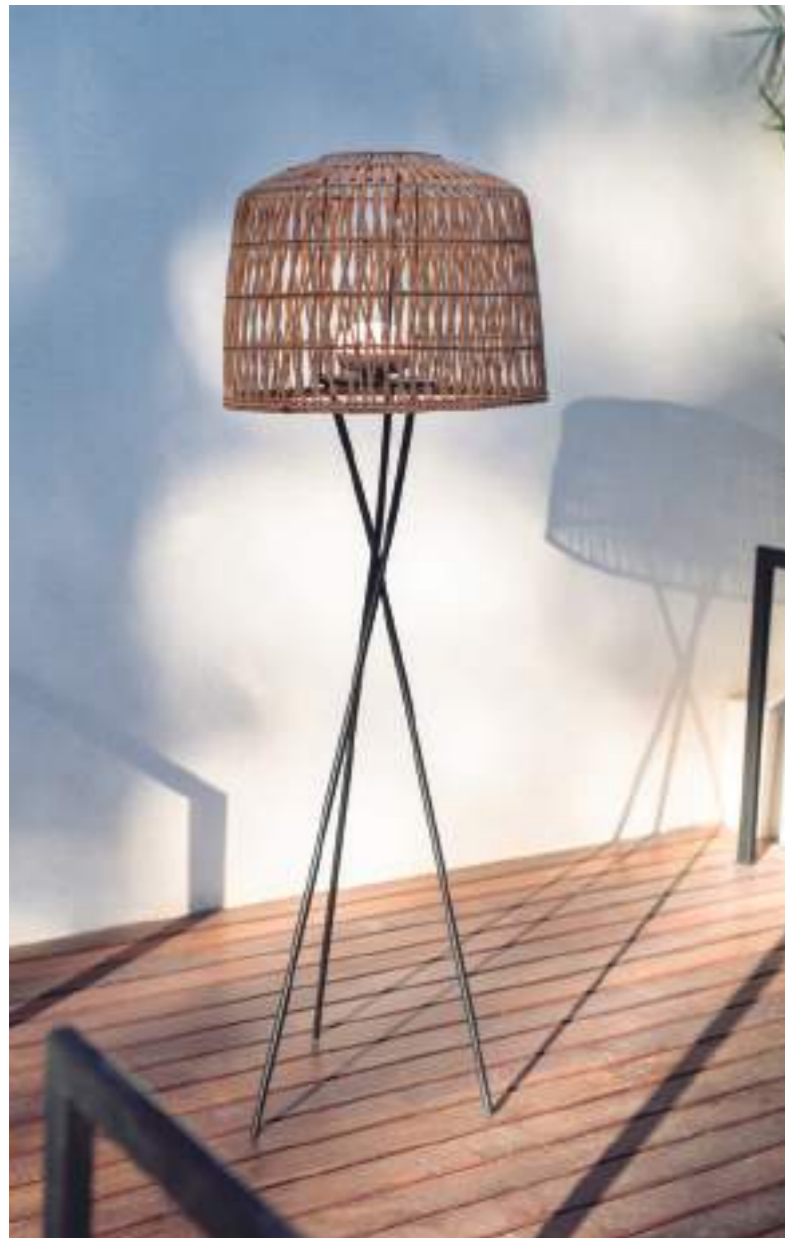

Amalfi

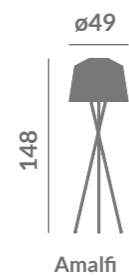

Options
Light

Battery

Amalfi

+ Info P. 170



Rechargeable Bulb
(Battery Version)





Lola Slim 120



Lola Slim 120







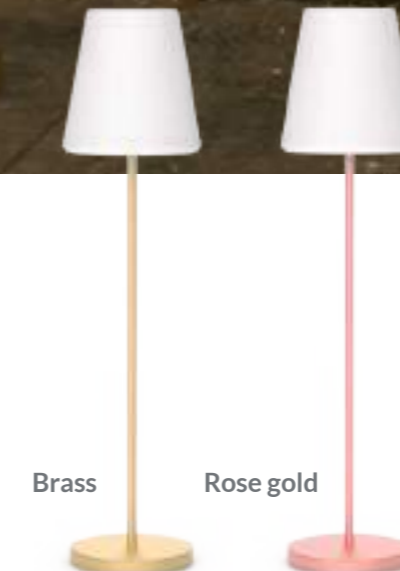

 ø28
 119
 Options
 Light |  Solar & battery  ● ● ● ●

Lola Slim 120 + Info P. 173



Lola Slim 180



 ø43
 177
 Options
 Light |  Cable ● ●  Solar & battery  ● ● ● ●

Lola Slim 180 + Info P. 173



Lola Slim 180

Lola Slim

Chloe plant



5 lamps
in 1 lamp

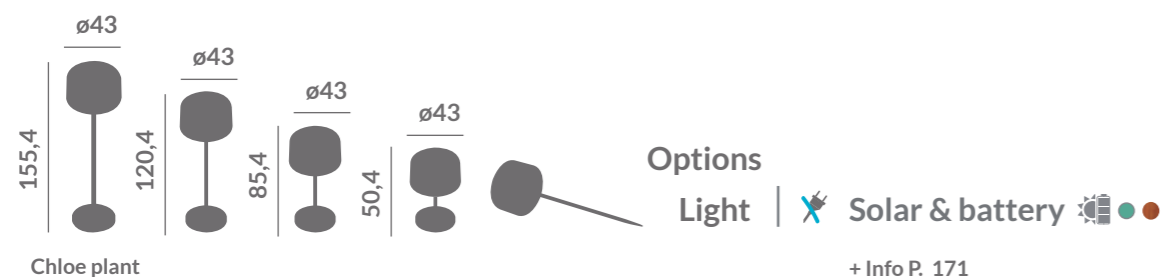

+ Info P. 171





CHLOE

lamp

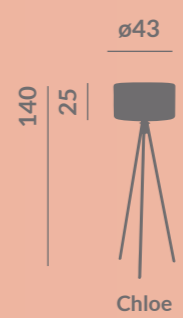

- Options
- Light
 - Cable
 - Solar & battery
- + Info P. 170

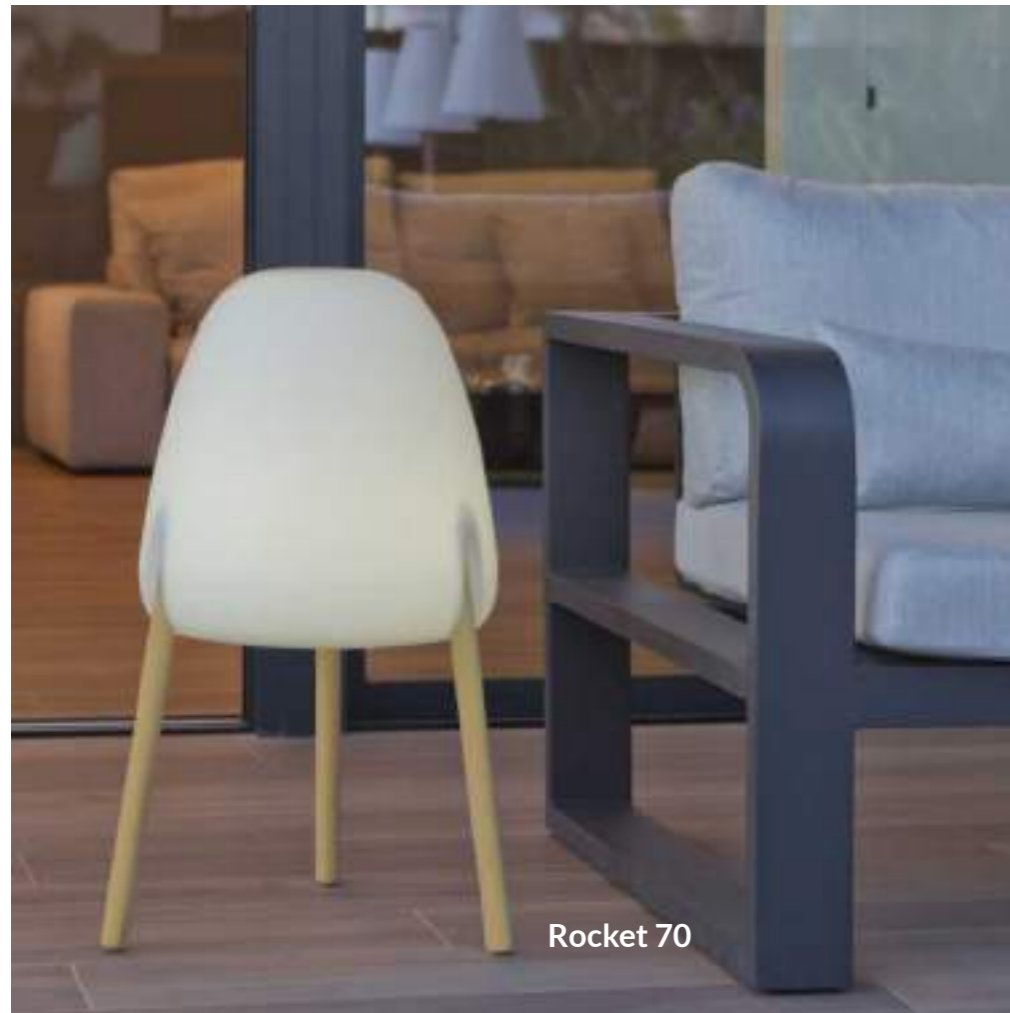

Rocket 70

Rocket 70

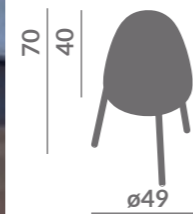

Options

- Light Cable
- Solar & battery

+ Info P. 174



Rocket 145

Rocket 145



Options

- Light Cable
- Solar & battery

+ Info P. 174

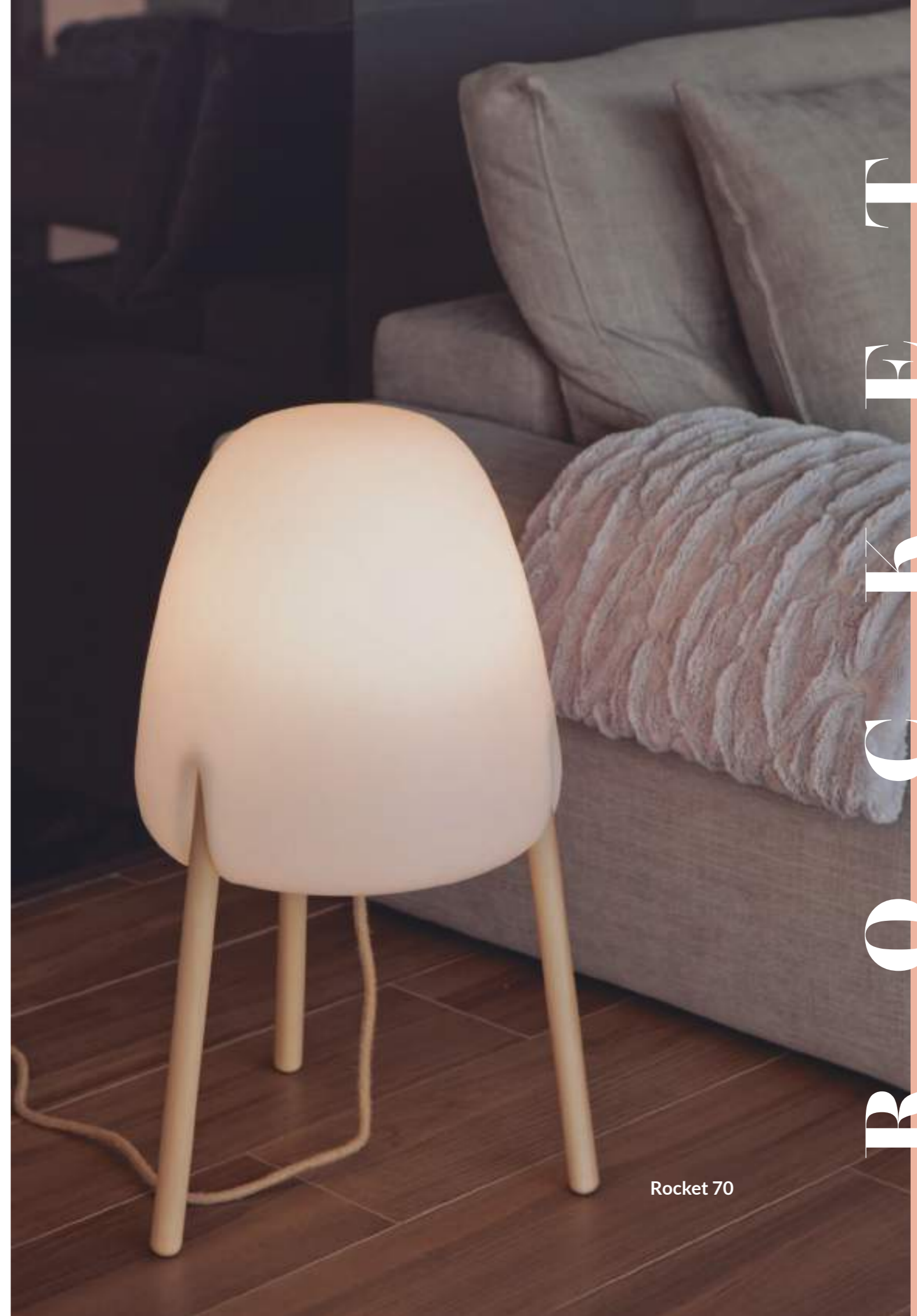

Rocket 70

R E C O R D

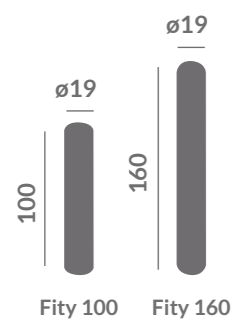

Options
Light

-  Cable
-  Battery

+ Info P. 171

Fity



Helga

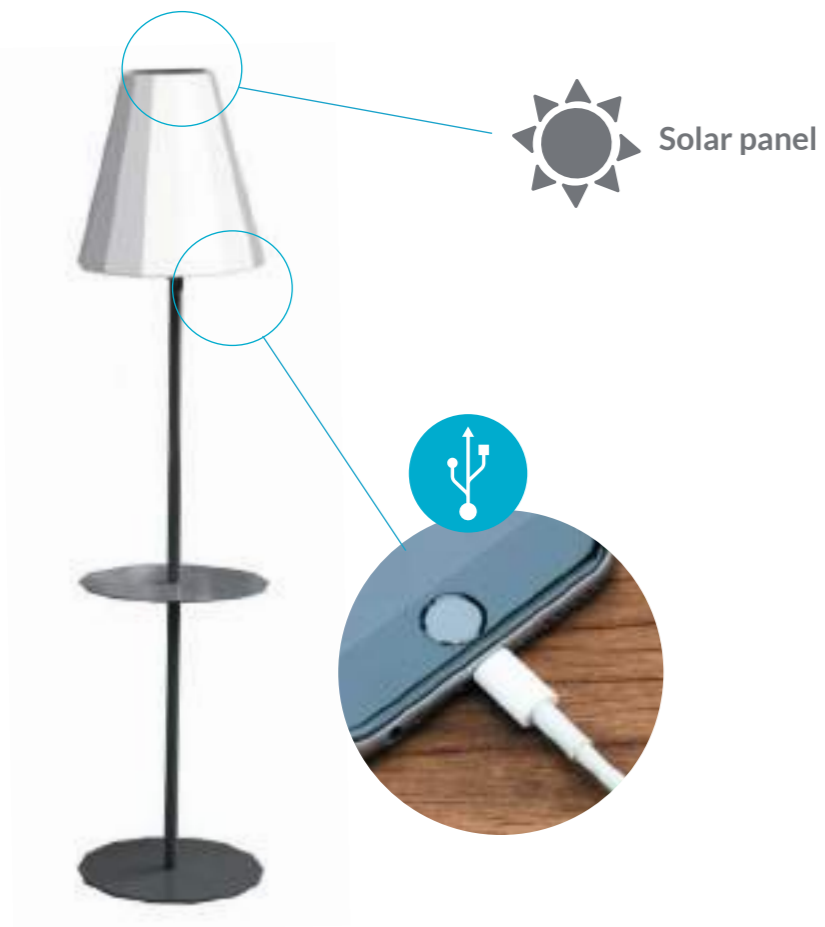

155
60 57
Helga

Options
Light

Solar & battery

+ Info P. 172



c'est
PANCHO

Options

Light



Cable



Battery

+ Info P. 174

139

61x43



Pancho



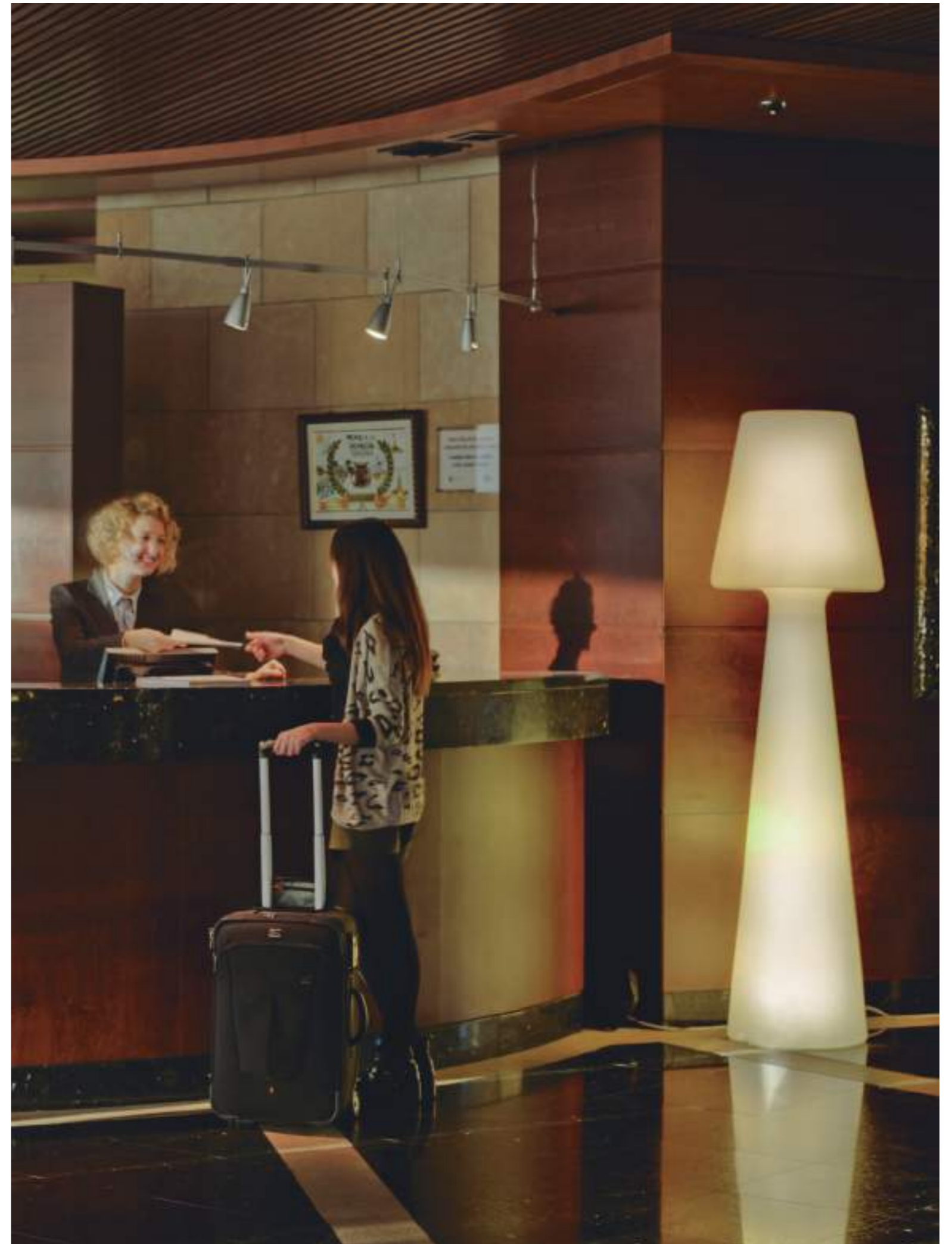

Lola

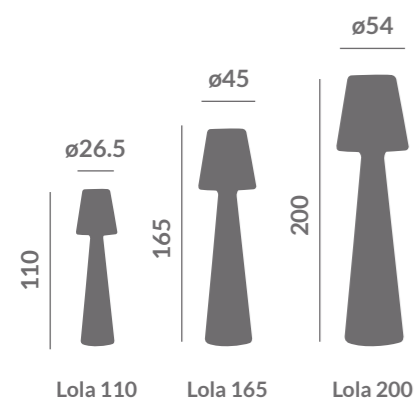

Options
Light

Cable
 Battery

+ Info P. 172, 173



Options

Light



Cable



Battery

+ Info P. 170

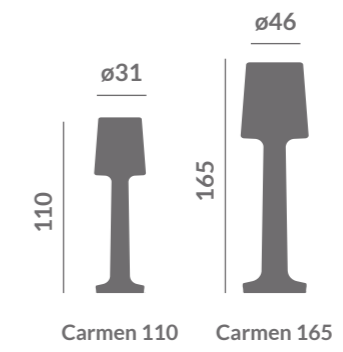

Carmen



Fredo



Options

Light

Cable Battery 

+ Info P. 171

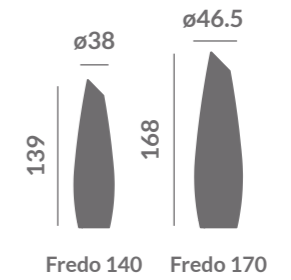

Fredo 140

Fredo 170





Options
Light

Cable
 Battery

+ Info P. 172



Konika



Options

Light



Cable



Battery

+ Info P. 172



Grace 140



Grace 170



Grace



Options
Light | Cable ●
+ Info P. 175

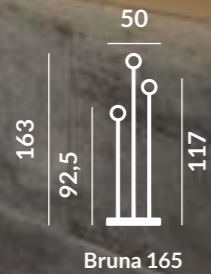

Bruna 165

Bruna



Light and Deco / Decorative / Brunna

Options
Light | Solar & battery ●
+ Info P.175

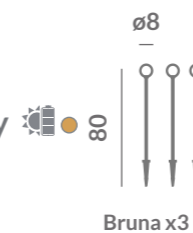

Bruna x3

Options
Light | Solar & battery ●
+ Info P. 174



Bruna x1



Gufo

Options

Light | Solar & battery 
+ Info P. 176

40 | $\varnothing 31$
Gufo 40



Samba

Options

Light | Cable
 Battery
+ Info P. 177

40 | $\varnothing 18$
Samba



Kaktus

Options

Light | Cable
 Battery

+ Info P. 176

100 | 44x31
Kaktus

Goa



Options

Light



Cable



Battery

+ Info P. 175, 176



Goa 40

Goa 70

Balans



Options

Light



Cable



Battery

+ Info P. 174

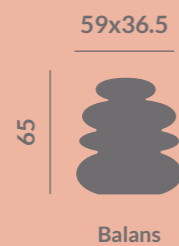

Balans

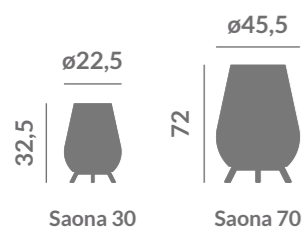

Options

Light

- Cable
- Battery

+ Info P. 177, 182

Saona



Sisine 70 Cable

Sisine 30 Batt



Sisine 70 Batt

Sisine 30 Batt

Light and Deco / Decorative - Table Lamps / Sisine



Sisine 30 Batt

Sisine

Options
Light

 Cable
 Battery

+ Info P. 177, 183

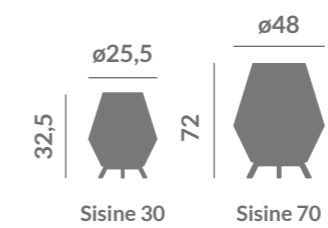

Sisine 30

Sisine 70





Rechargeable Bulb
(Battery Version)



Chloe

Options

Light

-  Cable
-  Solar & battery

+ Info P. 181

36



Chloe 35



Bossa

Light and Deco / Table Lamps / Chloe - Bossa



32,5
 ø22,5
 Bossa 30

Options

Light

-  Battery

+ Info P. 180



Rechargeable Bulb (Battery Version)

Enoki



Options

Light



Battery



+ Info P. 181



Lola 45

Options

Light



Cable



Battery



+ Info P. 181, 182

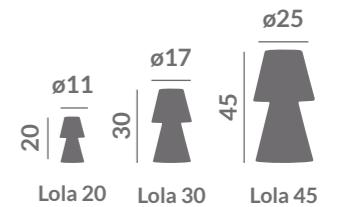

Lola 20

Lola 30

Lola 45



Lola 20



Lola 30



Lime Mint Anthracite





Brass Rose gold Space grey White



Light and Deco / Table lamps / Lola Slim

Lola Slim 30

 Options
 Light |  Battery 
 Lola Slim 30 + Info P. 182





Carmen

Options
 Light | Cable | Battery | $\varnothing 29$
 + Info P. 181 | 45 | Carmen 45



Panchito

Options
 Light | Battery | $\varnothing 20,6$ | 16,5
 + Info P. 182 | Panchito



Rocket

Options
 Light | Battery | $\varnothing 14,2$ | 19,4
 + Info P. 182 | Rocket 20



Stella



Options

- Light Cable
- Solar & battery

+ Info P. 178

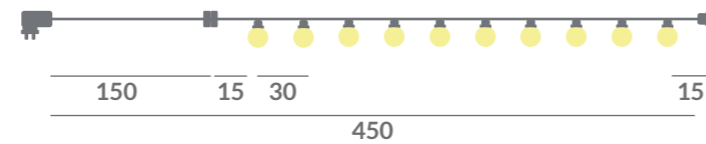

Aurora



Options

- Light Cable
- Solar & battery

+ Info P. 177

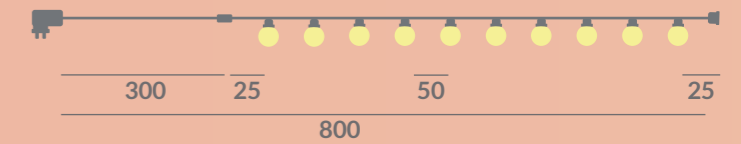

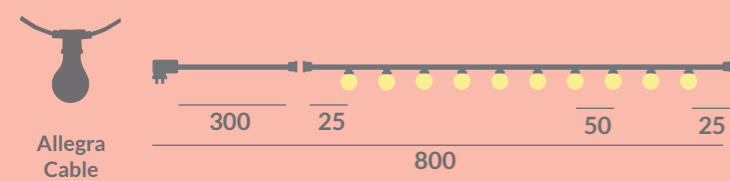

Options
Light | Cable ● ● ● ● ●
+ Info P. 177

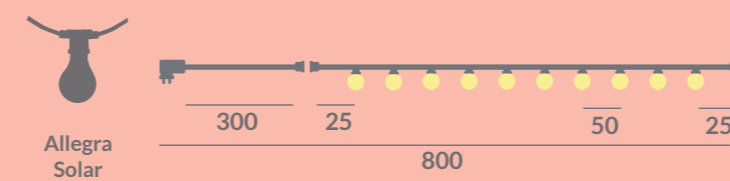

Options
Light | Solar & battery ● ● ● ● ●
+ Info P. 177



PORTABLE
WITHOUT CABLES



PORTABLE
WITHOUT CABLES



Si
mo
na

Options

Light |  Solar & battery
+ Info P. 180



Simona

Options

Light |  Solar & battery
+ Info P. 179



60
Ilaria



PORTABLE
WITHOUT CABLES



Options

Light |  Solar & battery 

+ Info P. 179

65



ø17,5

Chiara

Chiara



PORTABLE
WITHOUT CABLES



Options

Light |  Battery 

+ Info P. 180

49



ø31

Saona

Saona



Options

Light



Battery



+ Info P. 179

35

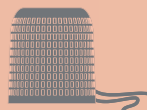

ø33

Positano



Posi tano

Light and Deco / Portable Hnag / Positano - Benirrás



Options

Light



Battery



+ Info P. 178

35



ø35

Benirrás



Beni rrás



PORTABLE
WITHOUT CABLES

PORTABLE
WITHOUT CABLES

Light and Deco / Portable Hang / Bossa - Sisine - Reona - Calobra

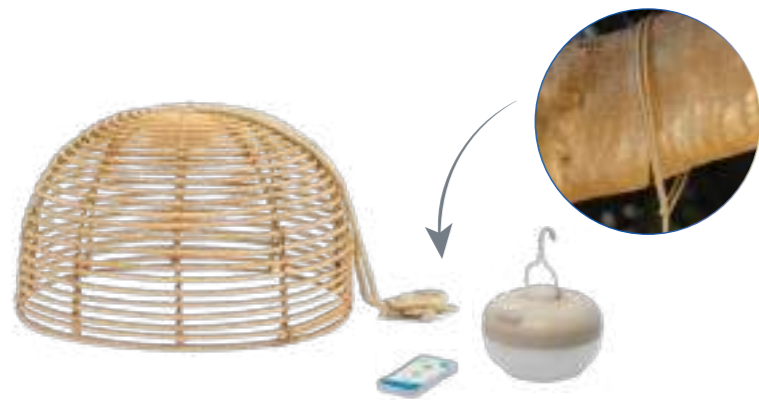

PORTABLE
WITHOUT CABLES



THREE LIGHT
INTENSITIES



Bossa

Options

Light | Battery

+ Info P. 178

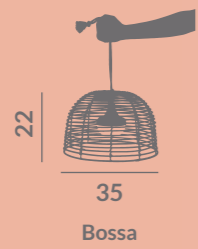

Sisine

Options

Light | Battery

+ Info P. 180

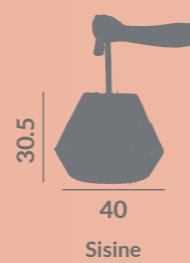

Reona

Options

Light | Battery

+ Info P. 179



Calobra

Options

Light | Battery

+ Info P. 178

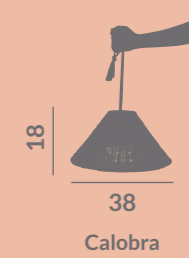

Norai



PORTABLE
WITHOUT CABLES

Options
Light

 Battery
+ Info P. 179

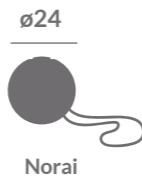

Bitá



Options
Light

 Battery
+ Info P. 178

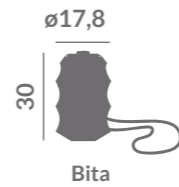

Sora



Options
Light

 Battery
+ Info P. 180

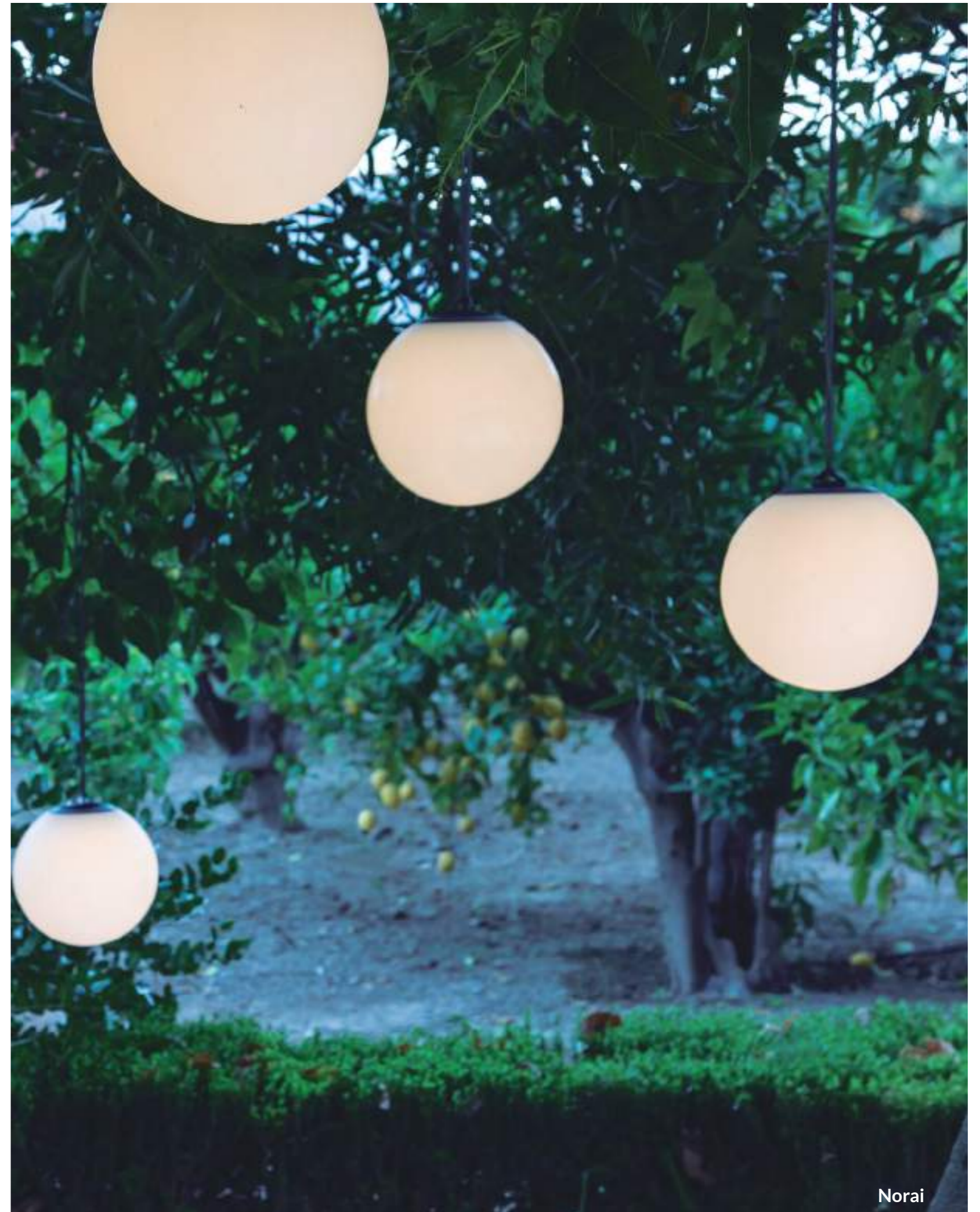
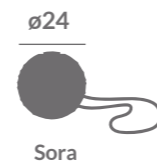

Norai



Candela

Options

Light | Battery 

+ Info P. 175



Candela



Kurby

Options

Light | Play light&music 
Solar & battery 

+ Info P. 176, 183



Kurby

*take me where
you want!*



Nóma da

Options

Light | Play light&music 
Solar & battery 

+ Info P. 176, 184



Nómada



Fa ra lay

Options

Light | Play light&music 
Solar & battery 

+ Info P. 175, 183



Faralay



Cuby play

Options

Light

✖ Play light&music 🎵

+ Info P. 183



Nipper

Options

Light

✖ Play light&music 🎵

+ Info P. 184

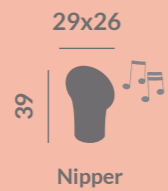

Cherry

Options

Light

✖ Battery 🔋

+ Info P. 185

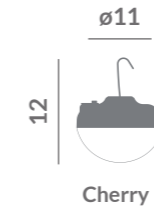

3 bulbs in 1





Pepita Wall

Pepita 215

Pepita 45

Pepita

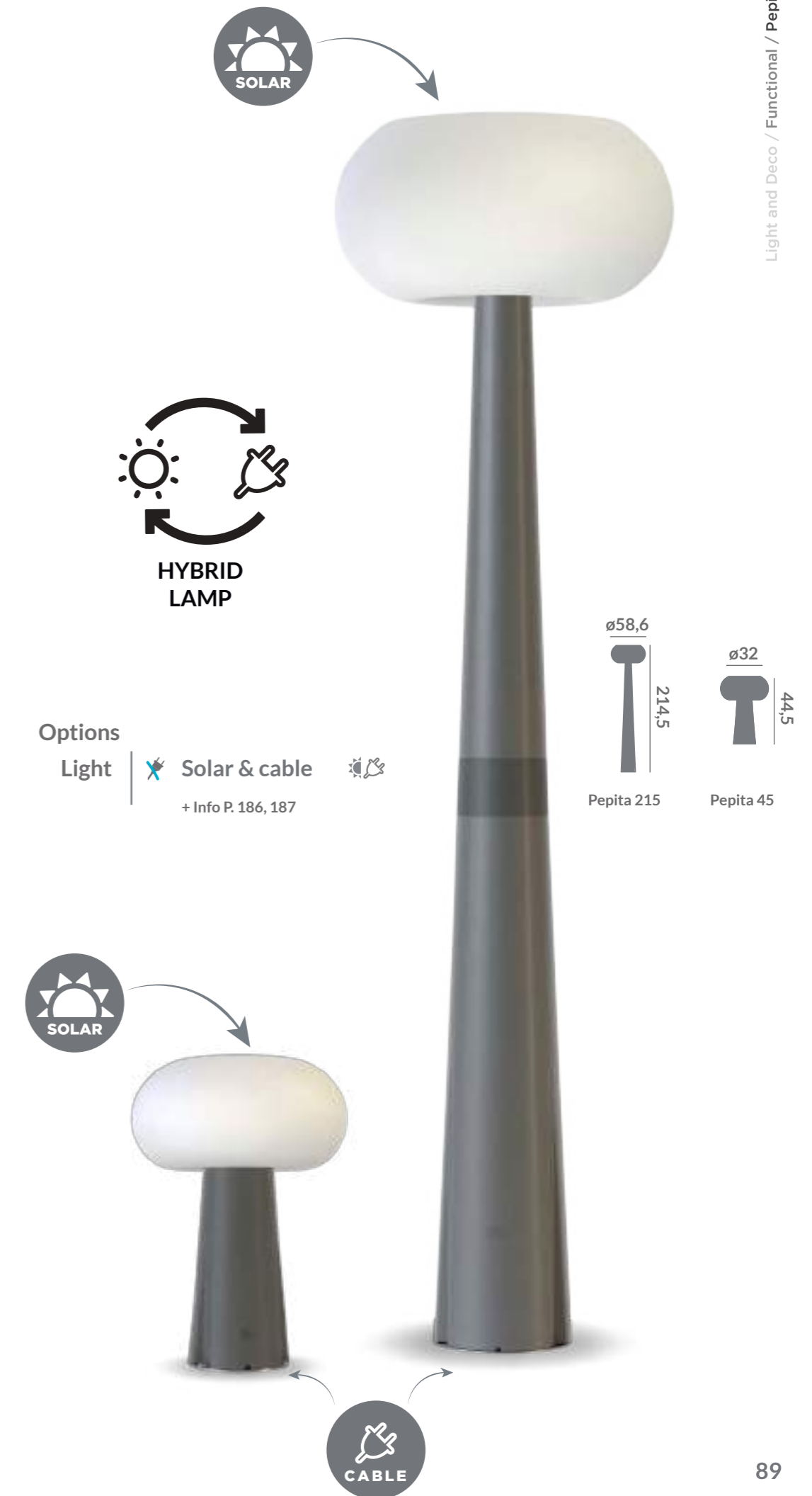



Paquita

Options
Light



Solar

+ Info P. 186



Paquita 215



Paquita 40



Light and Deco / Functional / Paquita





5 lamps
in 1 lamp

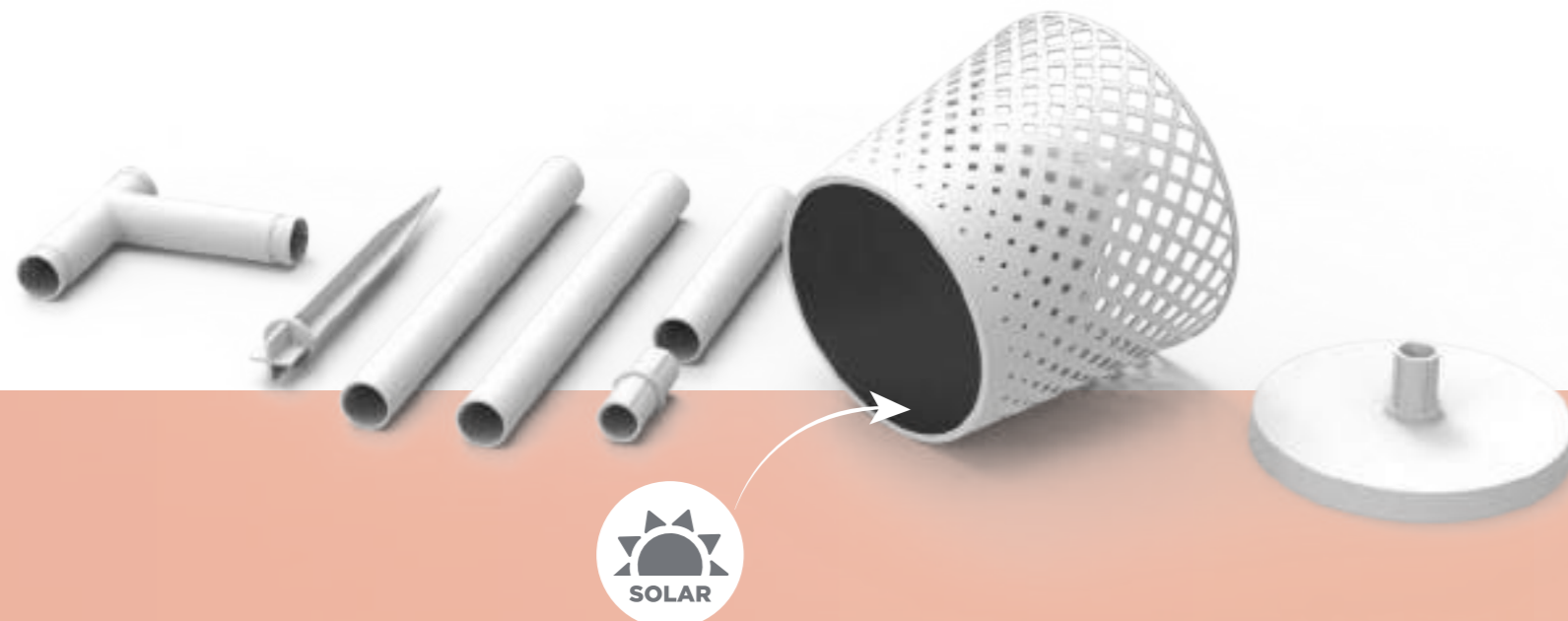

Table Lamp



High Ground Spike Lamp

Light and Deco / Functional / Greta



Options

Light

Solar & battery

+ Info P. 185



Greta



Floor Lamp



Small Ground Spike Lamp



Wall Lamp



Claudy, Balby & Buly hang



Options
Light | ↑ Hang ❄️ ○
+ Info P. 184, 185

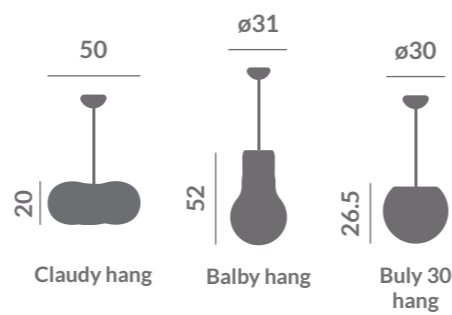

Petra hang

Options
Light | ↑ Hang ❄️
+ Info P. 187

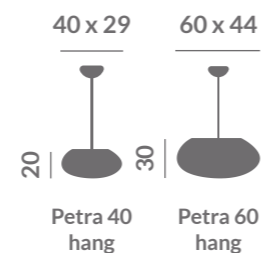

Rechargeable Bulb (Battery Version)

Sisine wall

Options
Light | ❄️ Battery
+ Info P. 187

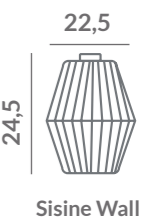



Cuby wall



Lola wall



Cápsula terpe



Buly wall

Options
Light | Wall 
+ Info P. 184, 185, 186

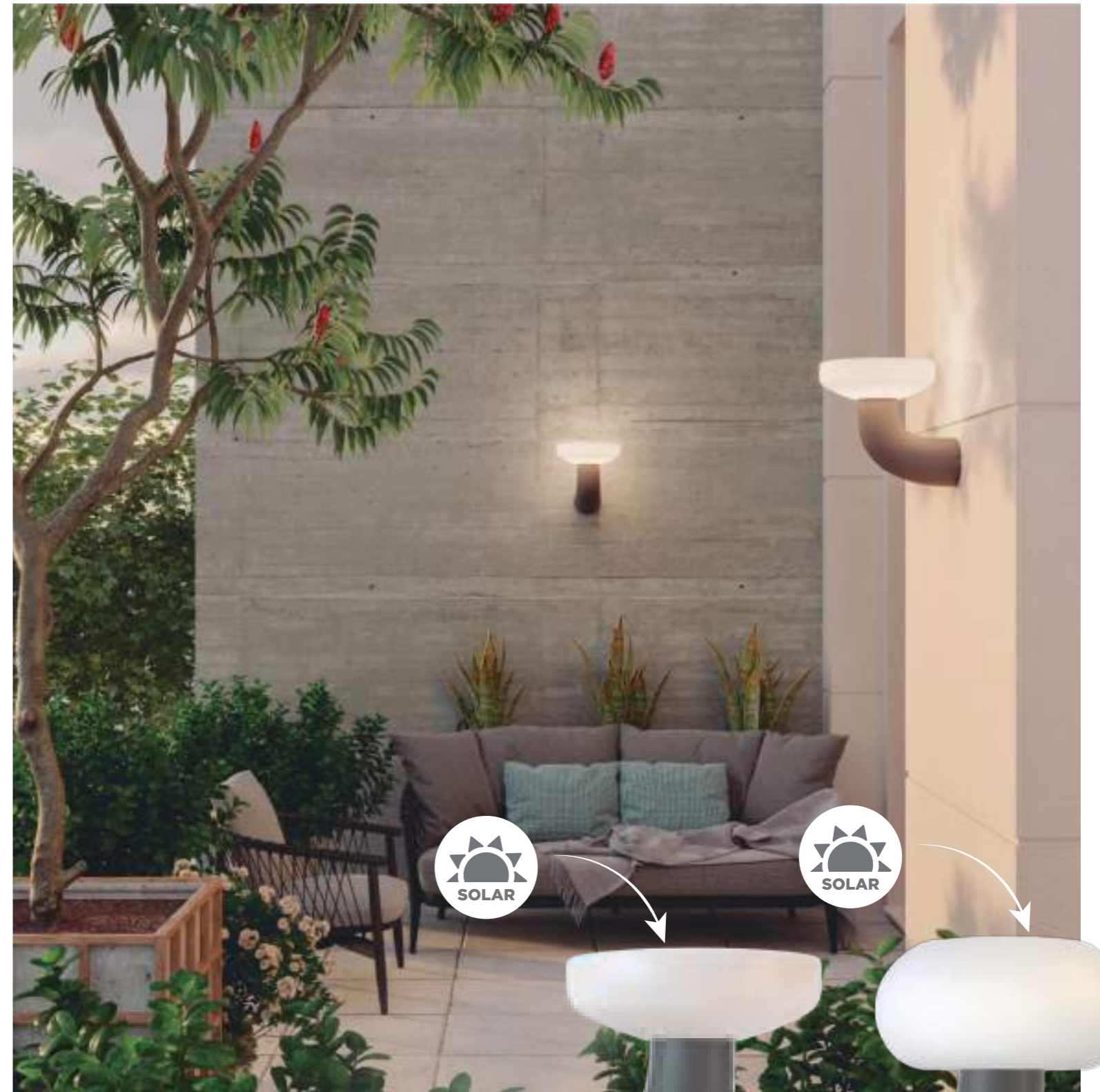
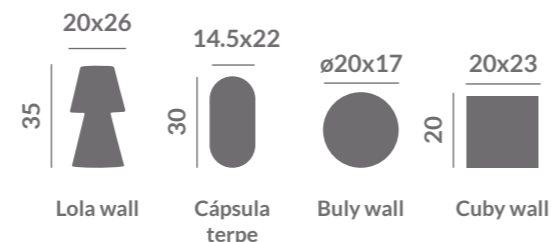

Pepita & Paquita

Options
Light |  Solar & cable  Solar 
+ Info P. 186, 187

Paquita Wall

Pepita Wall

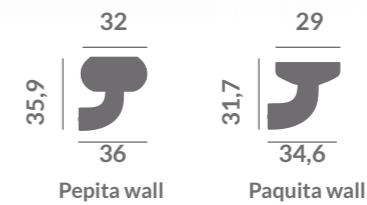
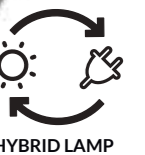



Buly

Do you prefer it with white light or with 256 colours?

Do you want it with solar & battery charge or with cable?



You have 6 different sizes!

LED

choose your best option

6 Sizes	Wireless	Solar charge & Rechargeable Battery	Cable	Floating
Remote Control	Colorfull Lighting	White Light	Translucent White	

Options

- Cable
- Solar & battery
- Floating

+ Info P. 188, 189

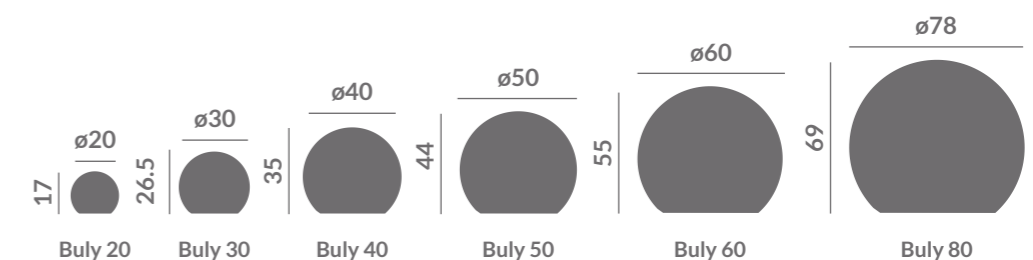

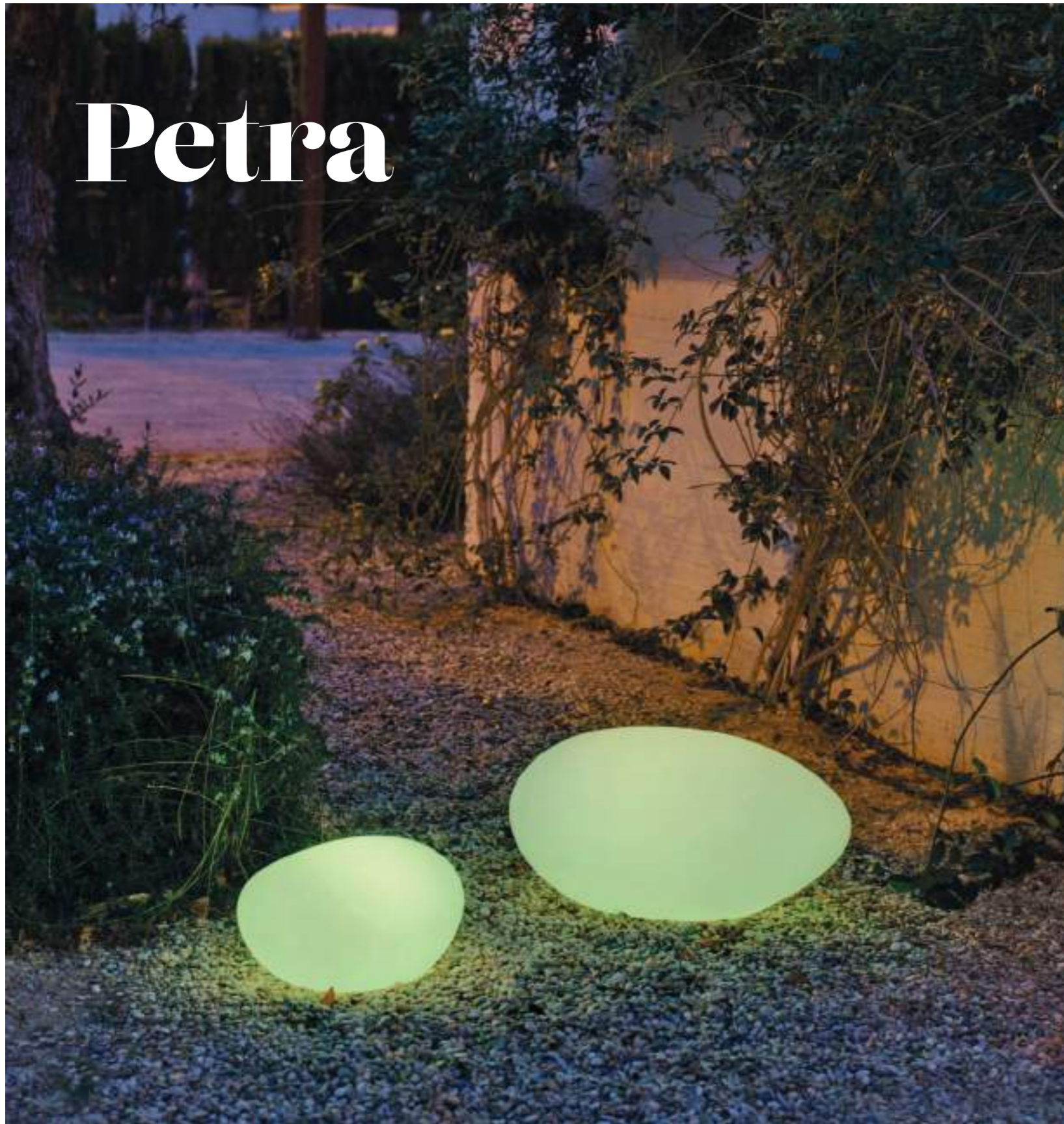

Petra



Options

Light

 Cable
 Solar & battery

+ Info P. 190

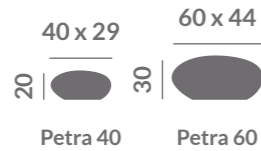



Cuby family



Options

Light

 Cable
 Solar & battery

+ Info P. 189, 190

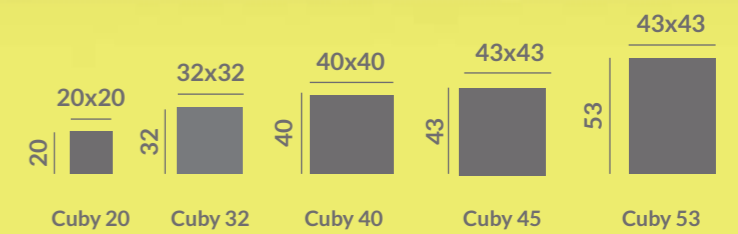

Furni ture





Rasa.



Options

Color

203x80

37



Rasa

+ Info P.194



Options

- Light | Cable
- | Solar + Battery
- Color |

Textile accessories



Formentera

Jamaica, Aruba & Martinica



Options

- Light | Cable Solar + battery

- Color | + Info P. 192, 193



New Island

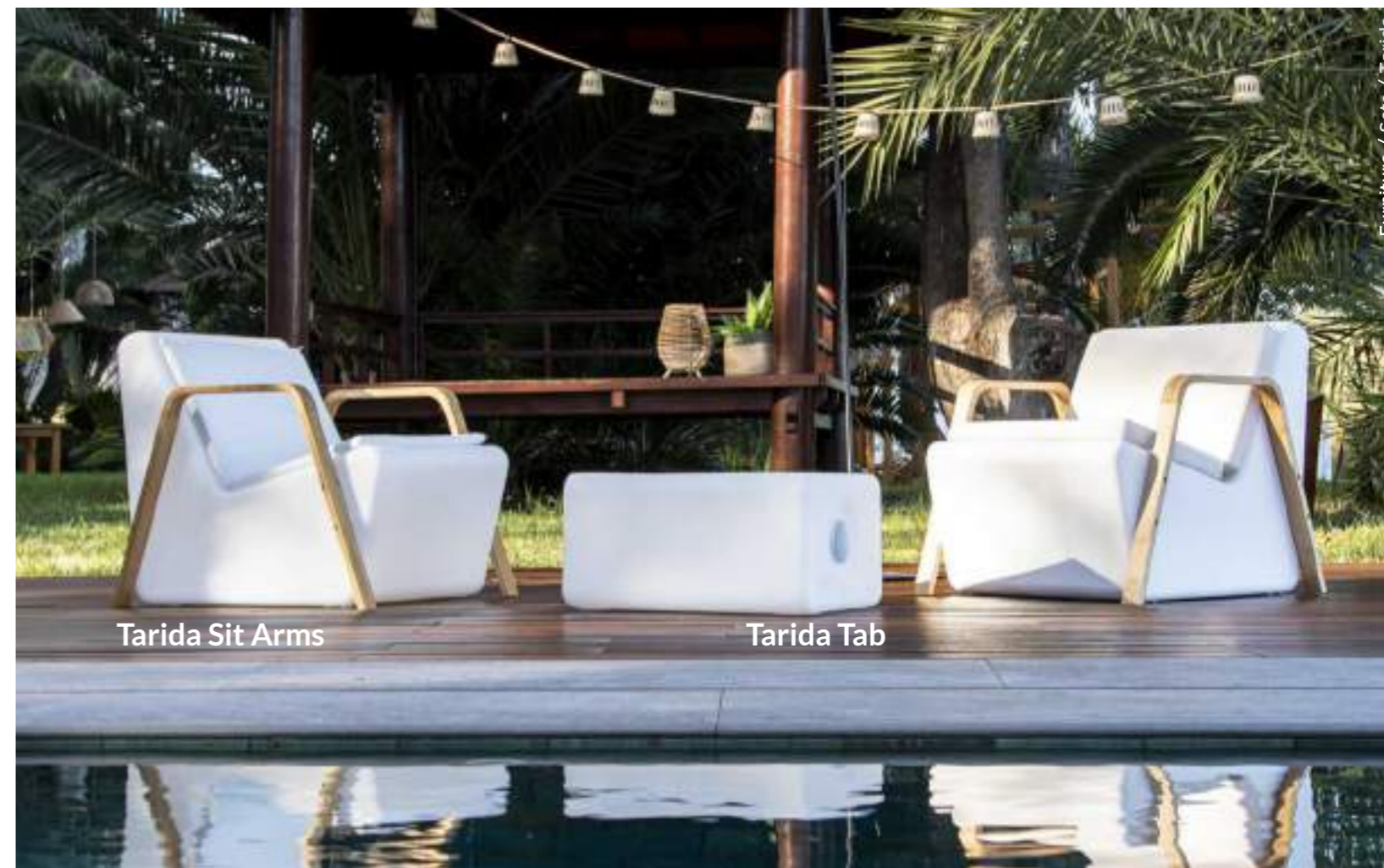

Options

- Light | Solar & battery
- Light | Play light&music

Color |

+ Info P. 192, 194



Tarida sit textil accessory included
Tarida tab cover included





Capri & Mallorca

Options

Light Cable Solar + Battery 

Color

+ Info P. 191, 193

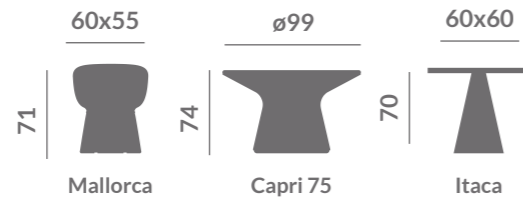

Tables cover included
Itaca weight stability included



Itaca & Mallorca



Furniture / Tables / Bora

Bora Wood

Bora Marble

Cuby

Options

Light

- Play light&music
- Cable
- Solar + Battery

+ Info P. 191



Cuby 45 play



Cuby 45



Cuby 53



Bora Wood

Bora Marble

Bora

Options

Light

- Cable

Color

-

+ Info P. 190

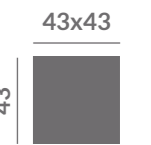

Bora

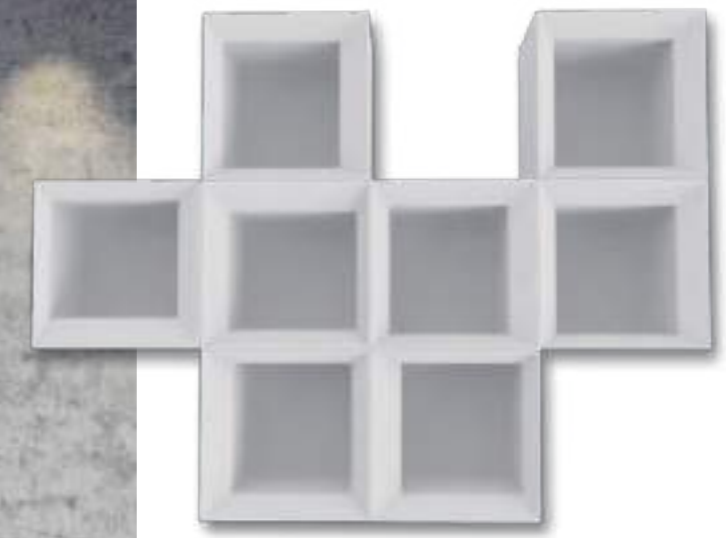

Calvin & Melvin

Options

- Light | Solar + Battery Play light&music

Color |

+ Info P.192

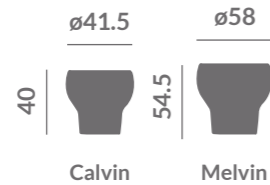

Melvin cover included

Options

- Light | Cable

Color |

+ Info P.195

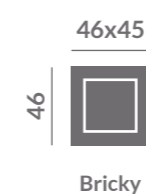

Bricky

get creative!

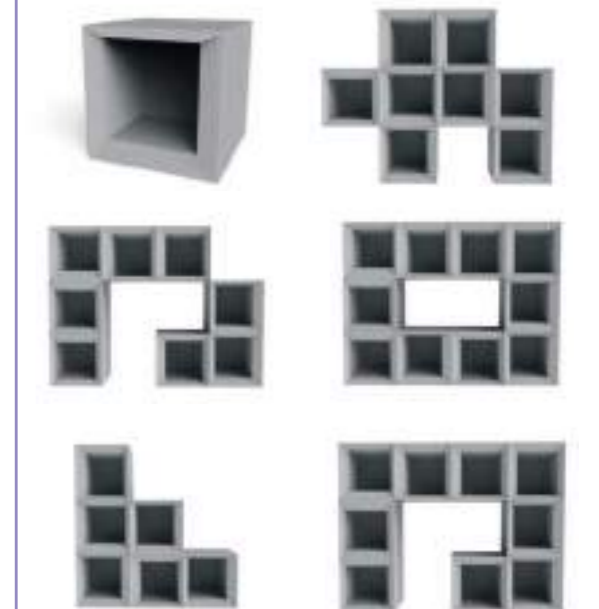



Sicilia

- Options
- Light Cable Solar + Battery
- Color

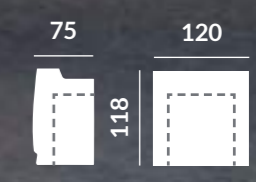

+ Info P. 196

Sicilia 75

Sicilia 120

Ibiza





Creta



Options

Light

-  Cable
-  Solar + Battery

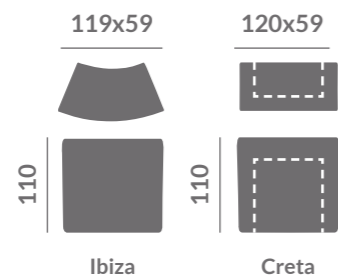

+ Info P. 195

Cover included - Shelf not included



Palma Bottle Rack

Options

Light | Solar + Battery 

Cooler accessory optional

+ Info P. 195

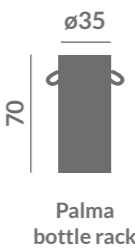

Woody Bottle Rack

Options

Light | Play light&music  | Solar + Battery 

Cooler accessory included



+ Info P. 196



Capri & Corfu



Options

- Light
- Solar + Battery 
 - Battery 

- Color
- + Info P. 191, 193



Capri cover included



Pufy & Tafy

Options

Color | ○ ●

+ Info P. 194

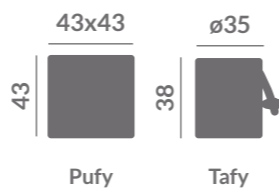

Capri & Corfu

Options

Light | Solar + Battery

Color | ○

+ Info P. 190, 193

Capri cover included

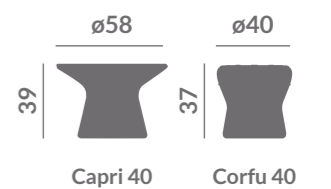

Furniture / Sets / Pufy & Tafy - Capri & Corfu

Flower pots —



Olivo



Olivo Large



Olivo 50

Olivo High

Options

Color | ○ ● ● ● ● ●

+ Info P. 205, 206

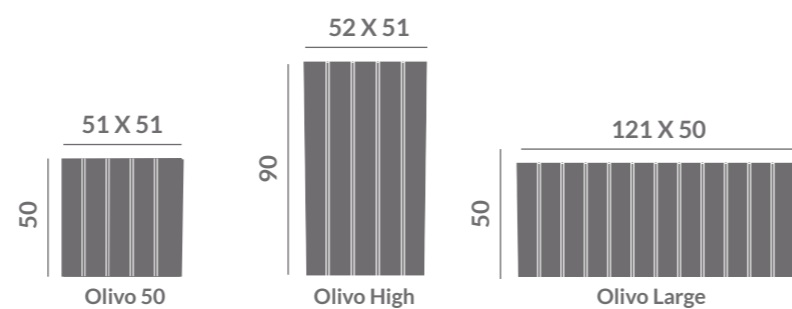



Options

Color |

+ Info P. 196, 197

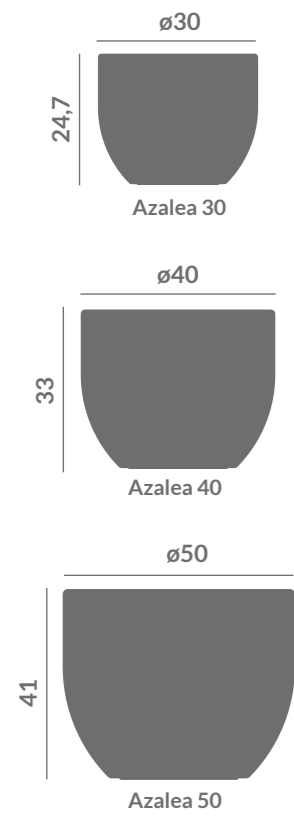

Azalea

Azalea 30 Azalea 40 Azalea 50

Hortensia

Options

Color | ○ ● ● ● ● ● ● ● ● ● ●

+ Info P. 200, 201

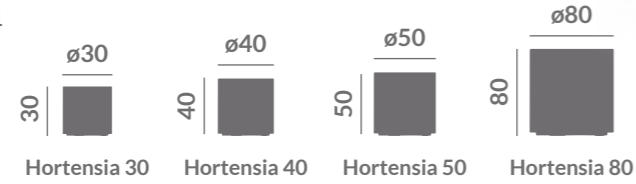

Lift Accessory
Available only for Hortensia 30 ● ●



Hortensia 40



Hortensia 30 + Lift Accessory



Hortensia 40

Hortensia 30

Hortensia 50

Hortensia 80



Magnolia 130



Magnolia



Magnolia 45

Options

Light

- Cable
- Solar & battery

Color

-

+ Info P. 202, 203

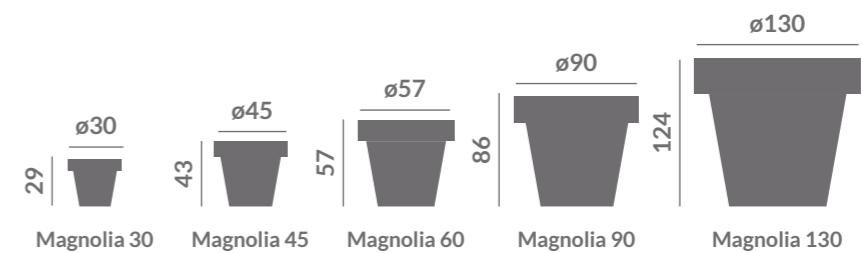



Melisa

Options

- Light
 - Cable
 - Solar & battery

- Color
 -

+ Info P. 203, 204

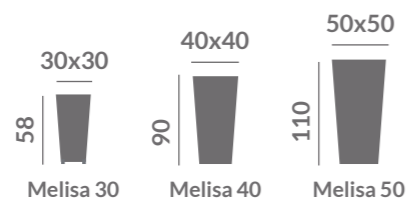

Melisa 50



Options

- Light Cable Solar & battery 

- Color

+ Info P.199



Ficus 60



Ficus 80

Ficus

Bambú

Options

- Light Cable Battery 

- Color

- Cooler accessory 

+ Info P.197

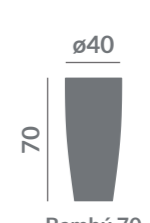

Bambú 70

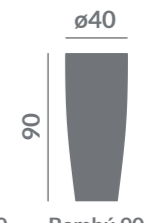

Bambú 90

Bambu 70



Options

Light | Solar & battery 

Color |

90x37

79

Palmera

+ Info P. 206

Palmera



Flowerpots / Palmera - Junco

Options

Light | Cable Solar & battery 

Color |

80

80x32

Junco 80

+ Info P. 202

Junco



Jara

Options

Color | ○ ● ● ● ● ● ● ● ● ● ●

+ Info P. 201, 202

	100x35	100x40
32		
	Jara 100x35	Jara 100x40



Narciso

Options

Light | ✕ Solar & battery

Color | ○ ● ● ● ● ● ● ● ● ● ●

	35x35	40x40	49x49	59x59
32				
	Narciso 35	Narciso 40	Narciso 50	Narciso 60

Options

Light |  Cable
 Solar & battery 

Color | ● ● ● ●
+ Info P. 198 y 199

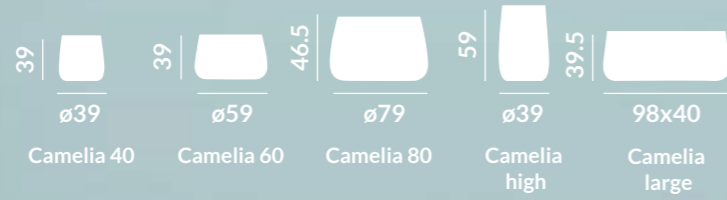

Camelia





Options

Light

- Cable
- Solar & battery

+ Info P. 206



Palma 70



Gerbera

Options

Color |

+ Info P. 199, 200

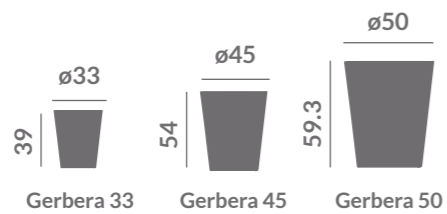

Violeta

Options

Light | Solar & battery

Color |

+ Info P. 206, 207



Technical Data

Technical Data

1. Materials
2. Polyethylene Textures
3. Colours & Finishes
4. Use according to IP
5. Lighting System
6. Glossary
7. Measurement & References

. Lighting

- . Floor lamps
- . Decorative
- . Garland
- . Portable Hang
- . Table Lamps
- . Speakers
- . Functional
- . Essentials

. Furniture

- . Tables
- . Seats
- . Bar

. Flowerpots

1- MATERIALS

	Material	Find it at:
Plastic	Polyethylene (PE)	It is mainly found in products manufactured by rotational moulding.
	ABS	Enoki, Chiara, Norai, Bitá, Sora
	PVC	Coating of the Garland bulbs.
	Silicone	Rocket 20, Panchito
	Polyamide	Nómada Handle
	PP Difusor	Lola Slim 30, Lola 20
	Recycled Plastic	Greta
Metal	Iron Painted	Chloe Plant, Lola slim, Helga, Amalfi, Niza, Bruna
	Aluminium	Cooler
	Steel	Weight Paquita, Pepita & Fity
Organic	Phenolic Compounds	Itaca, Creta accesory
	Bamboo*	Reona, Ilaria, Tarida Arms
	Ratán*	Amalfi, Bossa, Calobra, Saona
	Jute*	Allegra, Aurora garlands
	Seagrass *	Benirrás, Positano, Sisine, Niza
	Beech Wood *	Chloe, Rocket family
Crystal	Crystal	Chiara, Ilaria, Simona Bulbs
Fabric	Composition: 80% pvc 18% pes 2% pu	Mattres & Pillow Formentera, Tarida Sit
Vegan Leather	Synthetic leather. Polyurethane.*	Kurby, Faralay, Woody handle
Ceramic		Bora marble
Methacrylate	High resistance to external aggressions Non-porous surface	Creta, Ibiza, Tarida tab, Capri family, Melvin, Sicilia.

(*) For correct maintenance, it is advisable to protect it from rain, direct exposure to the sun and sudden changes in temperature. The bamboo, rattan, beech or seagrass are natural materials, reason why changes of colour or cracks can happen. In case they are wanted to be exposed to the elements, it is recommended to protect them with some oil or varnish adapted for the material in concrete regularly, thus will prolong the protection to rain, the rays UV and will extend the life of the product. To clean them up, use a cloth or brush to remove dust and a sponge slightly moistened with neutral soap and rub gently. For more information, please consult us.

2 - POLYETHYLENE TEXTURES

The finishes of Newgarden products made of polyethylene have a visually smooth and soft granulated finish that is very pleasant to the touch.

SMOOTH TEXTURE
Polyethylene

The rustic finish can be found in a very specific selection of flowerpots.

RUSTIC TEXTURE
Polyethylene

3- COLOURS & FINISHES

TRANSLUCENTS polyethylene & ABS

TRANSLUCENT WHITE
Polyethylene

TRANSLUCENT LIME
Polyethylene

OPAQUES polyethylene

OPAQUE WHITE
Polyethylene

OPAQUE BLACK
Polyethylene

OPAQUE BRONZE
Polyethylene

OPAQUE ANTHRACITE
Polyethylene

OPAQUE TERRACOTA
Polyethylene

OPAQUE TOPO
Polyethylene

Other materials

OPAQUE GLOSSY WHITE
ABS

OPAQUE GLOSSY BLACK
ABS

OPAQUE WHITE
Metal

OPAQUE ROSE GOLD
Metal

OPAQUE MINT
Metal

OPAQUE BRASS
Metal

OPAQUE PINK
ABS

OPAQUE SPECIAL GREY
Metal

OPAQUE ANTHRACITE
Metal

OPAQUE LIME
Metal

OPAQUE WOOD EFFECT
Metal

OPAQUE GREY
ABS

OPAQUE BEIGE
ABS

4- USE ACCORDING TO IP

We are going to explain in a very simple way the possibilities of use of Newgarden products according to their IP (index of protection of the electrical or electronic system against external agents)

IP20

Newgarden products with IP20 can only be used indoors, the electrical system, switches or cables must be protected from direct contact with water. Remember that although the product is made of Polyethylene resistant to the outside, this electrical system is designed for **indoor use only**.



IP43

Newgarden products with IP 43 / 44 can be used outdoors, it is protected against dust and weak and very moderate rain. **If this product also has accessories made of natural fibres, wood or metal parts, it is advisable to protect it from direct contact with water and humidity.** Store in a dry place after use. In the event of rain or very adverse weather conditions, it should be protected from the elements to avoid future problems.



IP44

IP54

Newgarden products with IP 54 **can be used outdoors, are protected against dust and light rain.** If this product also has accessories made of natural fibres, wood or metal parts, it is advisable to protect it from direct contact with water and humidity. Store in a dry place after use. In case of rain or very adverse weather conditions it must be protected from the weather to avoid future problems.



IP65

Newgarden products with IP 65 **can be used outdoors, they are airtight against dust and rain. If this product also has accessories made of natural fibres, wood or metal parts, it is advisable to protect it from direct contact with water and humidity.** Store in a dry place after use. In case of rain or very adverse weather conditions it must be protected from the weather to avoid future problems.



IP68

Newgarden products with IP 68 can be used outdoors, they are airtight against dust and rain. **It is also floating (not submersible) so you can use it in your pool.** In case of very adverse weather conditions it must be protected from the elements to avoid future problems.



5- LIGHTING SYSTEM

CABLE



CABLE OUTDOOR USE | LIGHT BULB

LIGHTING



FURNITURE



POTS



LED white light Bulb 6500K (INCLUDED)

IP65

Outdoor use



CABLE OUTDOOR USE | LIGHT TUBE



LED TUBE



LED white light Tube 6500K (INCLUDED)

IP65

Outdoor use



BRICKY CABLE OUTDOOR USE | INTEGRATED RGB LIGHT



Bricky



LED RGB light Bulb (INCLUDED)



Remote control (INCLUDED)

IP44

Outdoor use

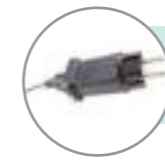

BRUNA CABLE OUTDOOR USE | INTEGRATED LIGHT BULB



Bruna Cable



LED warm light Bulb 3000K (INCLUDED)

IP44

Outdoor use



JUTE CABLE OUTDOOR USE | LIGHT BULB

LIGHTING



FURNITURE



LED bulb range 2700 to 6500K (warm, cold and neutral light) (INCLUDED)



Remote control (INCLUDED)

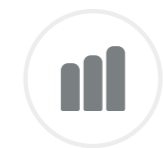

Dimmable Adjustable light intensity and temperature

IP65

Outdoor use



JUTE CABLE OUTDOOR USE | LIGHT TUBE



Fity 100



Fity 160

LED TUBE



LED white light Tube 6500K (INCLUDED)



Remote control (INCLUDED)



Dimmable Adjustable light intensity

IP65

Outdoor use

JUTE CABLE OUTDOOR USE | INTEGRATED LIGHT



Chloe 35



LED warm light Bulb 4000K (INCLUDED)



Touch control



Dimmable Adjustable light intensity



Outdoor use

GARLANDS JUTE CABLE OUTDOOR USE | LIGHT BULB



Aurora



Allegra



LED warm light Bulb 2700K (INCLUDED)



Connect multiple garlands



Outdoor use

GARLANDS CABLE OUTDOOR USE | LIGHT BULB



Allegra White



Allegra Black



Allegra Pink



LED warm light Bulb 2700K (INCLUDED)



Connect multiple garlands



Outdoor use

GARLAND TRANSPARENT CABLE OUTDOOR USE | INTEGRATED LIGHT



Stella



LED warm light Bulb 2700K (INCLUDED)



Connect multiple garlands



Outdoor use

GARLANDS CABLE OUTDOOR USE | RGB LIGHT



Allegra Black RGB



LED RGB light Bulb (INCLUDED)



Remote control (INCLUDED)



Outdoor use

TRANSPARENT CABLE INDOOR USE | LIGHT BULB



Carmen 45



Samba



LED warm light Bulb 2700K (INCLUDED)



Hand switch



Indoor use

SOLAR

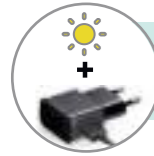

SOLAR + RECHARGEABLE BATTERY INDOOR & OUTDOOR USE

LIGHTING



FURNITURE



POTS



LED RGB light Bulb (INCLUDED)



Integrated LED range 2700 to 6500K (warm, cold and neutral light) (INCLUDED)



Remote control (INCLUDED)



Twilight sensor



Dimmable Adjustable light intensity and temperature



Outdoor use

Buly 20 / 30 / 40 Floating, Non sumersible

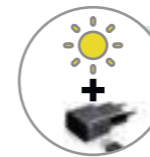

SOLAR + RECHARGEABLE BATTERY INDOOR & OUTDOOR USE



Chiara



Ilaria



Simona



LED warm light Bulb 2700K (INCLUDED)



Remote control (INCLUDED)



Dimmable Adjustable light intensity.



Outdoor use

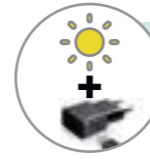

SOLAR + RECHARGEABLE BATTERY INDOOR & OUTDOOR USE



Allegra Black



Allegra White



Stella



Helga



LED warm light Bulb 2700 /3000K (INCLUDED)

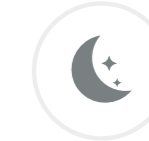

Twilight sensor



Outdoor use



SOLAR + RECHARGEABLE BATTERY INDOOR & OUTDOOR USE



Greta



Bruna x1



Bruna x3



Integrated LED warm light, 3000K (INCLUDED)



Twilight sensor

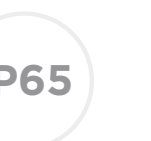

Outdoor use

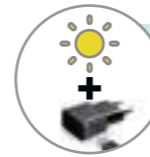

SOLAR + RECHARGEABLE BATTERY INDOOR & OUTDOOR USE JUTE CABLE



Aurora



Allegra



LED warm light Bulb 2700 (INCLUDED)

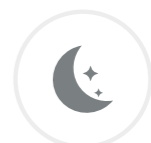

Twilight sensor



Outdoor use

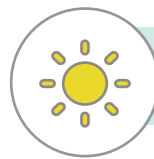

SOLAR AUTOMATIC OUTDOOR USE | INTEGRATED LIGHT



Buly 20



Petra 40



Only Solar Charge



LED white light Bulb 6000K (INCLUDED)



Twilight sensor



Floating, Non sumersible



Outdoor use

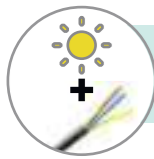

SOLAR HIBRYD OUTDOOR USE | INTEGRATED LIGHT



Pepita farola



Pepita sobremuro



Pepita wall

With sun:



Without sun:



Solar Charge & power supply



LED warm light Bulb 4000K (INCLUDED)



Remote control (INCLUDED)

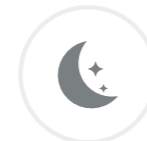

Twilight sensor



Motion sensor



Outdoor use

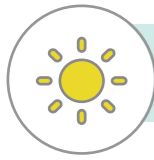

SOLAR OUTDOOR USE | INTEGRATED LIGHT



Paquita farola



Paquita sobremuro



Paquita wall



Only Solar Charge



LED warm light Bulb 4000K (INCLUDED)



Remote control (INCLUDED)

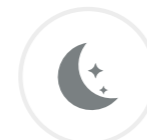

Twilight sensor



Motion sensor



Outdoor use

BATTERY



RECHARGEABLE BATTERY INDOOR & OUTDOOR USE | CHERRY BULB

LIGHTING



Amalfi



Benirrás



Bossa 30



Bossa Hang



Calobra Hang



Cherry Bulb



Niza



Positano Hang



Reona Hang



Saona 30



Saona 70



Saona Hang



Sisine 30



Sisine 70



Sisine Hang



Sisine Wall



LED warm light Bulb 2700K (INCLUDED)



Remote control (INCLUDED)



Dimmable Adjustable light intensity.



Outdoor use



RECHARGEABLE BATTERY INDOOR & OUTDOOR USE | LIGHT TUBE



Balans



Carmen 45



Carmen 110



Carmen 165



Fity 100



Fity 160



Fredo 140



Fredo 170



Goa 40



Goa 70



Grace 110



Grace 140



Kaktus

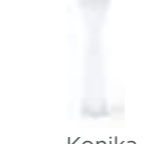

Konika



Lola 30



Lola 45



Lola 110



Lola 165



Pancho



Capri 110

LED TUBE



LED RGB light Tube (INCLUDED)



Remote control (INCLUDED)



Dimmable Adjustable light intensity.



Outdoor use

RECHARGEABLE BATTERY INDOOR & OUTDOOR USE | LIGHT BULB



Bita

Candela

Norai

Samba

Sora

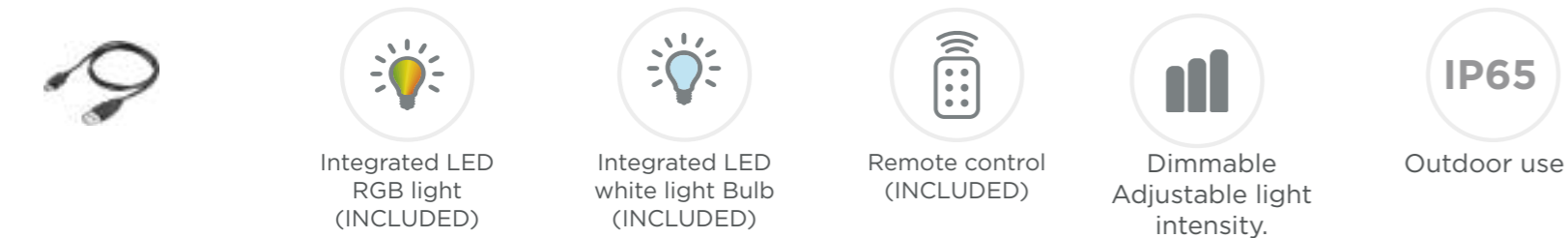

Integrated LED RGB light (INCLUDED)

Integrated LED white light Bulb (INCLUDED)

Remote control (INCLUDED)

Dimmable Adjustable light intensity.

Outdoor use

RECHARGEABLE BATTERY INDOOR & OUTDOOR USE |



Lola Slim 30

Enoki

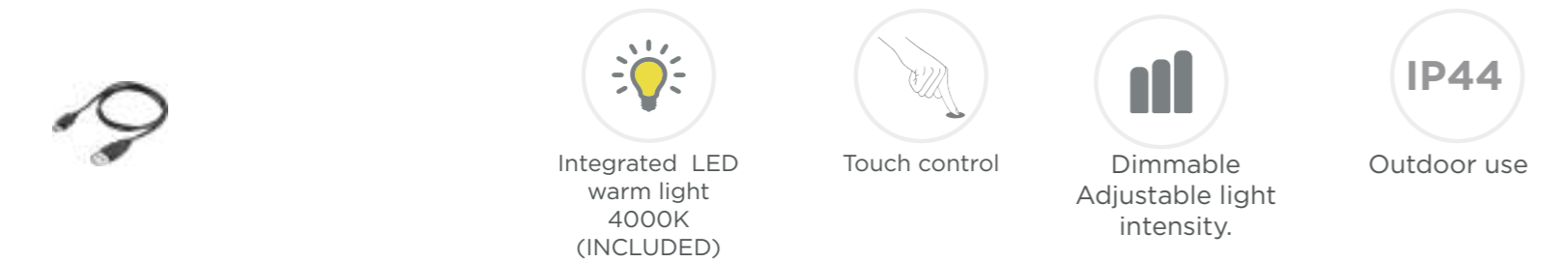

Integrated LED warm light 4000K (INCLUDED)

Touch control

Dimmable Adjustable light intensity.

Outdoor use

RECHARGEABLE BATTERY INDOOR & OUTDOOR USE | PANCHITO & ROCKET



Panchito

Rocket 20

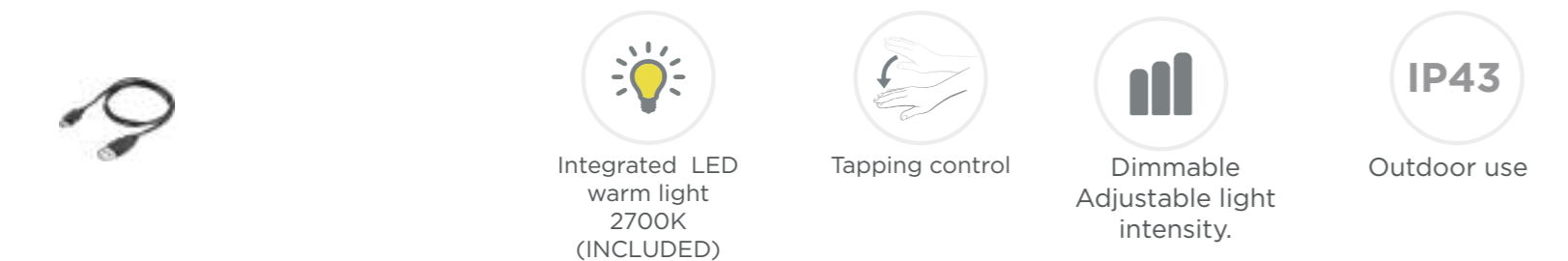

Integrated LED warm light 2700K (INCLUDED)

Tapping control

Dimmable Adjustable light intensity.

Outdoor use

RECHARGEABLE BATTERY INDOOR & OUTDOOR USE | LOLA 20 BATTERY



Lola 20

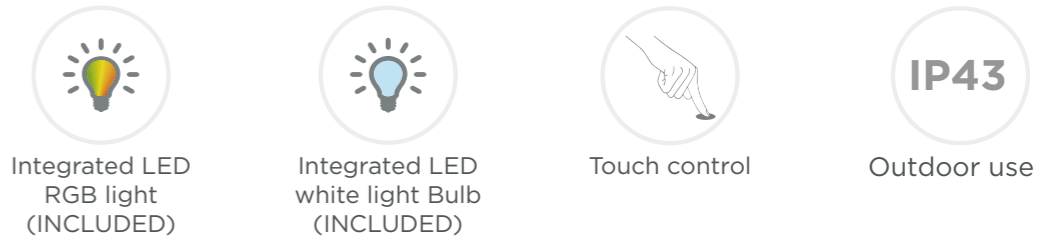

Integrated LED RGB light (INCLUDED)

Integrated LED white light Bulb (INCLUDED)

Touch control

Outdoor use

REPLACEABLES BATTERIES INDOOR USE | LOLA 20 AAA



Lola 20



Integrated LED RGB light (INCLUDED)

Smooth Mode Only Automatic change of colours in mixing

Outdoor use

PLAY: LIGHT & MUSIC INDOOR & OUTDOOR USE | INTEGRATED LIGHT & SPEAKERS RECHARGEABLE BATTERY



Calvin

Cuby 45

Faralay

Kurby

Nipper

Nómada

Tarida tab

Woody

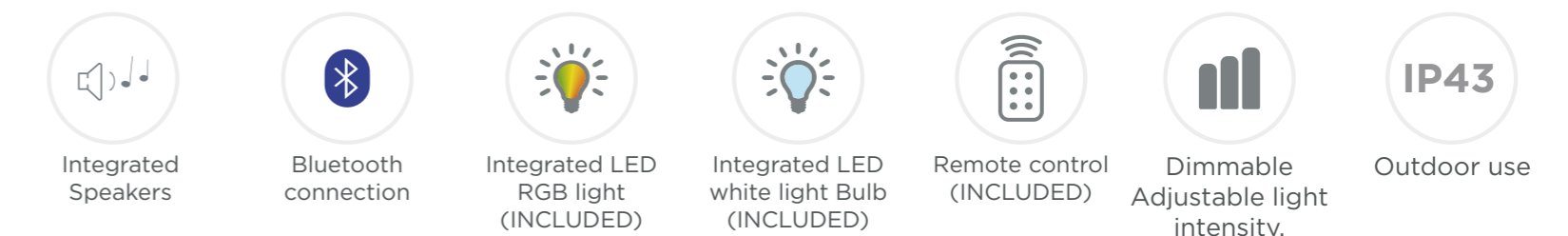

Integrated Speakers

Bluetooth connection

Integrated LED RGB light (INCLUDED)

Integrated LED white light Bulb (INCLUDED)

Remote control (INCLUDED)

Dimmable Adjustable light intensity.

Outdoor use



HANG OUTDOOR USE | BULB LIGHT NOT INCLUDED



Balby



Buly 30



Claudy



Petra 40
hang



Petra 60
hang



Installation required



E27 bulb cap



Outdoor use



WALL OUTDOOR USE | BULB LIGHT NOT INCLUDED



Buly 20
Wall



Cuby 20
Wall



Cápsula
terpe



Lola 35



Installation required



E27 bulb cap



Outdoor use

6. GLOSSARY

This technical catalogue is subject to periodic updates, the measurements or finishes may vary in future revisions.



COLD LIGHT
LUZ FRÍA
KALTES LICHT
LUMIÈRE FROIDE



RGB LIGHT
LUZ RGB
RGB-BELICHTUNG
LUMIÈRE RGB



WARM LIGHT
LUZ CÁLIDA
WARMES LICHT
LUMIÈRE CHAUDE



WARM LIGHT PORTABLE RECHARGEABLE BULB
BOMBILLA RECARGABLE PORTÁTIL LÚZ CÁLIDA
WARMES LICHT TRAGBARE WIEDERAUFLADBARE GLÜHBIRNE
AMPOULE PORTABLE RECHARGEABLE À LUMIÈRE CHAUDE



LED TUBE
TUBO LED
LED-ROHR
TUBE LED



REMOTE CONTROL
MANDO A DISTANCIA
FERNBEDIENUNG
TÉLÉCOMMANDE



DIMMER
DIMABLE
DIMMBAR
DIMABLE



TWILIGHT SENSOR
SENSOR CREPUSCULAR
DÄMMERUNGSSENSOR CAPTEUR
CRÉPUSCULAIRE



MOTION SENSOR
SENSOR DE MOVIMIENTO
BEWEGUNGSMELDER
DÉTECTEUR DE MOUVEMENT



TOUCH CONTROL
CONTROL TÁCTIL
BERÜHRUNGSKONTROLLE
CONTRÔLE DES TOUCHES



HANG
COLGANTE
ANHÄNGIGE
EN SUSPENS



INTEGRATED SPEAKER
ALTAVOZ INTEGRADO
INTEGRIERTER LAUTSPRECHER
CONFÉRENCIER INTÉGRÉ



FLOATING
FLOTANTE
SCHWIMMEND
FLOTTANT



PLANTATION VOLUME
VOLUMEN DE PLANTACIÓN
PFLANZVOLUMEN
OLUME DE PLANTATION

7. MEASUREMENT AND REFERENCES

LIGHTING

- FLOOR LAMPS — P 170
- GARLANDS — P 177
- TABLE LAMPS — P 180
- FUNCTIONAL — P 184
- DECORATIVE — P 174
- PORTABLE HANG — P 178
- SPEAKERS — P 183
- ESSENTIAL — P 188

FLOOR LAMPS

AMALFI

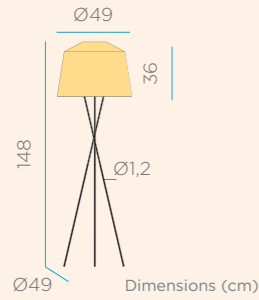

OPTIONS

Rechargeable Battery | Indoor & outdoor use | ● Black colour



lm

REFERENCES

900 LUMAMA145BXWLNW

Packaging: 58 x 50 x 63 cm | Gross Weight (Packaged Weight): 18,9kg

NATURE COLLECTION

CARMEN 110

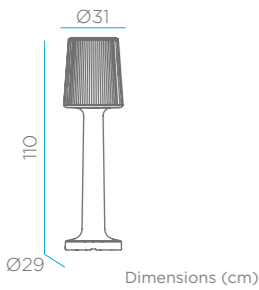

OPTIONS

Rechargeable Battery | Indoor & outdoor use
Cable | Indoor & outdoor use



lm

REFERENCES

360 LUMCR110WLNW
1.600 LUMCR110OFNW

Packaging: 31,5 x 31,5 x 112,5 cm | Gross Weight (Packaged Weight): 4,5kg | Floor anchorage included.

CARMEN 165

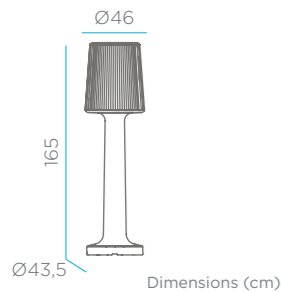

OPTIONS

Rechargeable Battery | Indoor & outdoor use
Cable | Indoor & outdoor use



lm

REFERENCES

415 LUMCR165WLNW
2.000 LUMCR165OFNW

Packaging: 46,4 x 46,4 x 165,5 cm | Gross Weight (Packaged Weight): 9,5kg | Floor anchorage included.

CHLOE 140

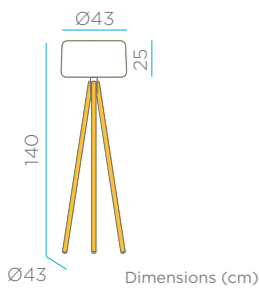

OPTIONS

Solar & Rechargeable Battery | Indoor & outdoor use
Cable Jute | IN&OUT Indoor & Outdoor use



lm

REFERENCES

600 LUMCHL140SSNW
860 LUMCHL140INOUTNW

Packaging: 31,6 x 46 x 123 cm | Gross Weight (Packaged Weight): 5,2 kg

CHLOE PLANT

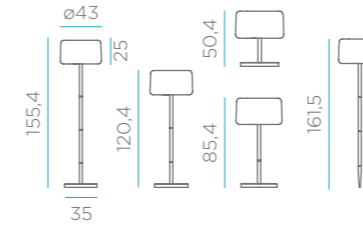

OPTIONS

Solar & Rechargeable Battery | Indoor & outdoor use | ● Wood colour
Solar & Rechargeable Battery | Indoor & outdoor use | ● Mint colour



lm

REFERENCES

600 LUMCHLPLTSSNW
600 LUMCHLPLTMSSNW

Packaging: 45,5 x 45,5 x 45,5 cm | Gross Weight (Packaged Weight): 13,5kg

Dimensions (cm)

FITY 100



OPTIONS

Rechargeable Battery | Indoor & outdoor use
Cable Jute | IN&OUT Indoor & outdoor use
Cable Jute | IN&OUT Indoor & outdoor use



lm

REFERENCES

360 LUMFT100TWLNW
1.400 LUMFT100OFNW
1.400 LUMFT100OCNW

Packaging: 19,5 x 19,5 x 105 cm | Gross Weight (Packaged Weight): 4,7kg | Weight stability included.

Dimensions (cm)

FITY 160



OPTIONS

Rechargeable Battery | Indoor & outdoor use
Cable Jute | IN&OUT Indoor & outdoor use
Cable Jute | IN&OUT Indoor & outdoor use



lm

REFERENCES

415 LUMFT160TWLNW
2.000 LUMFT160OFNW
2.000 LUMFT160OCNW

Packaging: 19,5 x 19,5 x 165 cm | Gross Weight (Packaged Weight): 6,2kg | Weight stability included.

Dimensions (cm)

FREDO 140

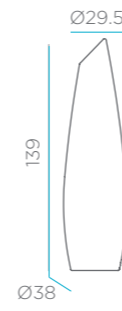

OPTIONS

Rechargeable Battery | Indoor & outdoor use
Cable | Indoor & outdoor use



lm

REFERENCES

360 LUMFD140WLNW
1.800 LUMFD140OFNW

Packaging: 39 x 39 x 140 cm | Gross Weight (Packaged Weight): 6kg | Floor anchorage included.

Dimensions (cm)

FREDO 170

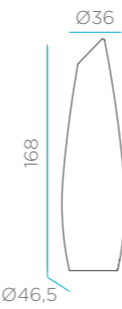

OPTIONS

Rechargeable Battery | Indoor & outdoor use
Cable | Indoor & outdoor use



lm

REFERENCES

415 LUMFD170WLNW
2.000 LUMFD170OFNW

Packaging: 48 x 48 x 170 cm | Gross Weight (Packaged Weight): 8,5kg | Floor anchorage included.

Dimensions (cm)

GLOSSARY This technical catalogue is subject to periodic updates, the measurements or finishes may vary in future revisions.

- ☀ White light (included)
- 🔥 Warm light (included)
- 🌈 RGB light (included)
- 🔋 Warm light portable rechargeable battery (included)
- 📡 LED Led tube lighting (included)
- 📶 Remote control (included)
- 🌙 Twilight sensor
- 👁 Motion sensor
- 📊 Dimmable
- 🌀 Hanging product
- 🌊 Floating, not submersible
- 🔊 Integrated speakers
- 👉 Touch control
- 💧 Volume of the plantation area

IP Indicates the level of protection of the electrical or electronic equipment against the entry of external agents: dust or water.

GLOSSARY This technical catalogue is subject to periodic updates, the measurements or finishes may vary in future revisions.

- ☀ White light (included)
- 🔥 Warm light (included)
- 🌈 RGB light (included)
- 🔋 Warm light portable rechargeable battery (included)
- 📡 LED Led tube lighting (included)
- 📶 Remote control (included)
- 🌙 Twilight sensor
- 👁 Motion sensor
- 📊 Dimmable
- 🌀 Hanging product
- 🌊 Floating, not submersible
- 🔊 Integrated speakers
- 👉 Touch control
- 💧 Volume of the plantation area

IP Indicates the level of protection of the electrical or electronic equipment against the entry of external agents: dust or water.

GRACE 140

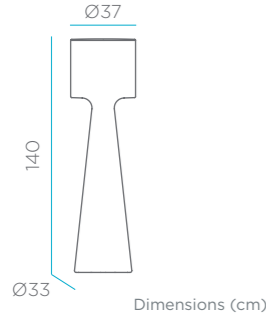

OPTIONS

- Rechargeable Battery | Indoor & outdoor use 390 LUMGC140WLNW
- Cable | Indoor & outdoor use 1.800 LUMGC140OFNW

Packaging: 38 x 38 x 140 cm | Gross Weight (Packaged Weight): 6,5kg | Floor anchorage included.

Im REFERENCES

GRACE 170

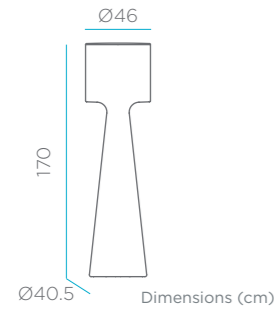

OPTIONS

- Rechargeable Battery | Indoor & outdoor use 415 LUMGC170WLNW
- Cable | Indoor & outdoor use 2.000 LUMGC170OFNW

Packaging: 46 x 46 x 170 cm | Gross Weight (Packaged Weight): 8,5kg | Floor anchorage included.

Im REFERENCES

HELGA

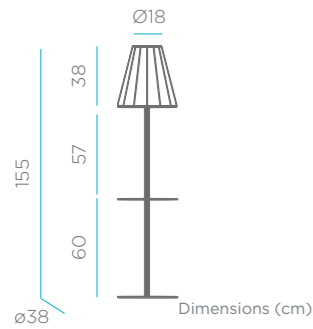

OPTIONS

- Solar + Rechargeable Battery | Indoor & outdoor use | Anthracite color 800 LUMHLA165SSNW

Packaging: 38 x 38 x 62 cm | Gross Weight (Packaged Weight): 10,2kg

Im REFERENCES

KONIKA 170

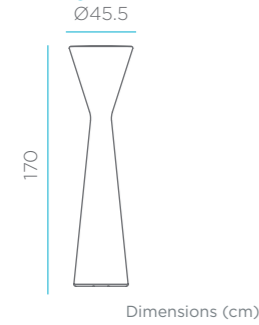

OPTIONS

- Rechargeable Battery | Indoor & outdoor use 415 LUMKNI170WLNW
- Cable | Indoor & outdoor use 2.000 LUMKNI170OFNW

Packaging: 45,8 x 45,8 x 171 cm | Gross Weight (Packaged Weight): 7,5kg | Floor anchorage included.

Im REFERENCES

LOLA 110

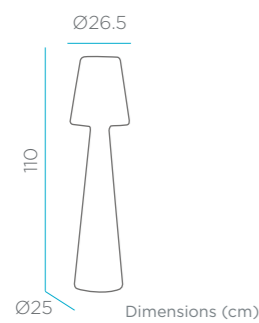

OPTIONS

- Rechargeable Battery | Indoor & outdoor use 360 LUMLL110WLNW
- Cable | Indoor & outdoor use 1.600 LUMLL110OFNW

Packaging: 26,5 x 26,5 x 111,5 cm | Gross Weight (Packaged Weight): 3,5kg | Floor anchorage included.

Im REFERENCES

LOLA 165

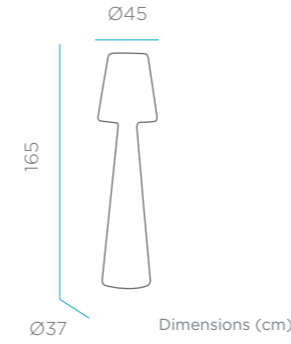

OPTIONS

- Rechargeable Battery | Indoor & outdoor use 415 LUMLL165WLNW
- Cable | Indoor & outdoor use 2.000 LUMLL165OFNW

Packaging: 45,5 x 45,5 x 166 cm | Gross Weight (Packaged Weight): 10,25kg | Floor anchorage included.

Im REFERENCES

LOLA 200

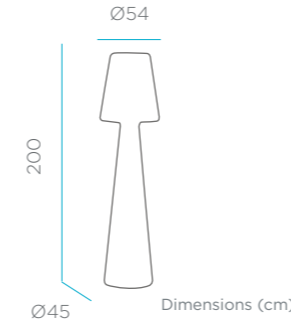

OPTIONS

- Cable | Indoor & outdoor use 2.200 LUMLL200OFNW

Packaging: 55,5 x 55,5 x 200,5 cm | Gross Weight (Packaged Weight): 12,5kg | Floor anchorage included.

Im REFERENCES

LOLA SLIM 120

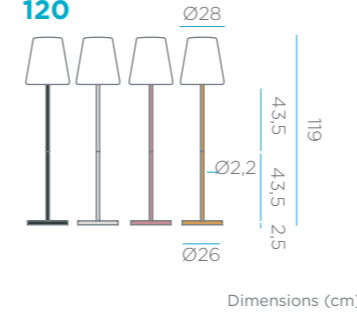

OPTIONS

- Solar & Rechargeable Battery | Indoor & outdoor use | Rose gold colour 600 LUMLLS120RGSSNW
- Solar & Rechargeable Battery | Indoor & outdoor use | Brass colour 600 LUMLLS120BRSSNW
- Solar & Rechargeable Battery | Indoor & outdoor use | Space grey colour 600 LUMLLS120GSSNW
- Solar & Rechargeable Battery | Indoor & outdoor use | Anthracite colour 600 LUMLLS120ANSSNW

Packaging: 29,8 x 29,8 x 39,5 cm | Gross Weight (Packaged Weight): 7kg | Weight stability included.

Im REFERENCES

LOLA SLIM 180

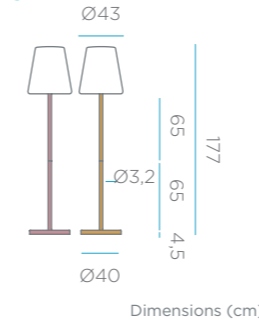

OPTIONS

- Solar & Rechargeable Battery | Indoor & outdoor use | Rose gold colour 800 LUMLLS180BRSSNW
- Cable Jute | IN&OUT Indoor & outdoor use | Rose gold colour 860 LUMLLS180BRINOUTNW
- Solar & Rechargeable Battery | Indoor & outdoor use | Brass colour 800 LUMLLS180RGSSNW
- Cable Jute | IN&OUT Indoor & outdoor use | Brass colour 860 LUMLLS180RGINOUTNW

Packaging: 47 x 54 x 57,5 cm | Gross Weight (Packaged Weight): 19,65kg | Weight stability included.

Im REFERENCES

NIZA

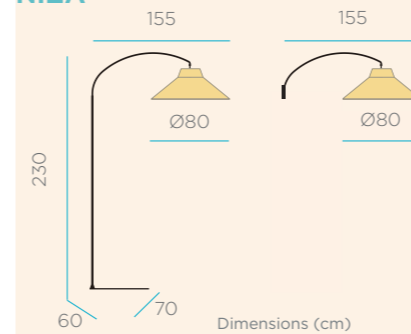

OPTIONS

- Rechargeable Battery | Indoor & outdoor use | Black colour 900 LUMNIZ230BXWLNW

Packaging: 91 x 81 x 45 cm | Gross Weight (Packaged Weight): 19kg

NATURE COLLECTION

GLOSSARY This technical catalogue is subject to periodic updates, the measurements or finishes may vary in future revisions.

White light (included) Warm light (included) RGB light (included) Warm light portable rechargeable battery (included) Led tube lighting (included) Remote control (included)

Twilight sensor Motion sensor Dimmable Hanging product Floating, not submersible Integrated speakers Touch control Volume of the plantation area

IP Indicates the level of protection of the electrical or electronic equipment against the entry of external agents: dust or water.

GLOSSARY This technical catalogue is subject to periodic updates, the measurements or finishes may vary in future revisions.

White light (included) Warm light (included) RGB light (included) Warm light portable rechargeable battery (included) Led tube lighting (included) Remote control (included)

Twilight sensor Motion sensor Dimmable Hanging product Floating, not submersible Integrated speakers Touch control Volume of the plantation area

IP Indicates the level of protection of the electrical or electronic equipment against the entry of external agents: dust or water.

PANCHO 140

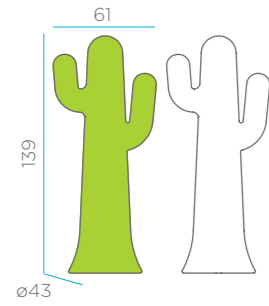

Dimensions (cm)

OPTIONS

Options	Im	REFERENCES
Rechargeable Battery Indoor & outdoor use	390	LUMPCI40WLNW
Cable Indoor & outdoor use	1.800	LUMPCI40OFNW
Cable Indoor & outdoor use Lime colour.	1.800	LUMPV140OFNW

Packaging: 44 x 51 x 140 cm | Gross Weight (Packaged Weight): 7kg | Floor anchorage included.

ROCKET 70

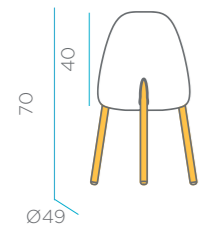

Dimensions (cm)

OPTIONS

Options	Im	REFERENCES
Solar & Rechargeable Battery Indoor & outdoor use	600	LUMRCK70SSNW
Cable Jute IN&OUT Indoor & outdoor use	860	LUMRCK70INOUTNW

Packaging: 37,5 x 37,5 x 43 cm | Gross Weight (Packaged Weight): 3kg

ROCKET 145

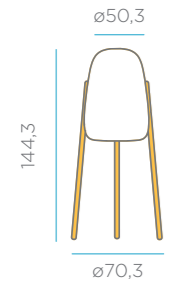

Dimensions (cm)

OPTIONS

Options	Im	REFERENCES
Solar & Rechargeable Battery Indoor & outdoor use	600	LUMRCK145SSNW
Cable Jute IN&OUT Indoor & outdoor use	860	LUMRCK145INOUTNW

Packaging: 51 x 50,5x 120,5 cm | Gross Weight (Packaged Weight): 8kg

DECORATIVE

BALANS

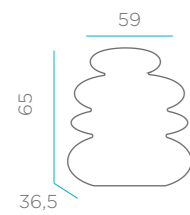

Dimensions (cm)

OPTIONS

Options	Im	REFERENCES
Rechargeable Battery Indoor & outdoor use	335	LUMBS070TWNW
Cable Indoor & outdoor use	900	LUMBS070OFNW

Packaging: 60 x 38 x 66,5 cm | Gross Weight (Packaged Weight): 4,5kg

BRUNA 80 x1

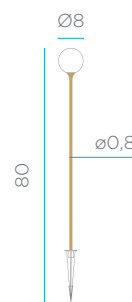

Dimensions (cm)

OPTIONS

Options	Im	REFERENCES
Solar & Rechargeable Battery Indoor & outdoor use Brass colour	38	LUMBRU081BRSWNW

Packaging: 12,8 x 12,8 x 76 cm | Gross Weight (Packaged Weight): 0,6kg.

BRUNA 80 x3

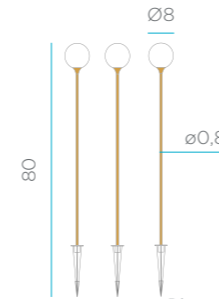

Dimensions (cm)

OPTIONS

Options	Im	REFERENCES
Solar & Rechargeable Battery Indoor & outdoor use Brass colour	115	LUMBRU080BRSWNW

Packaging: 12,8 x 20,8 x 76 cm | Gross Weight (Packaged Weight): 1kg.

BRUNA 165

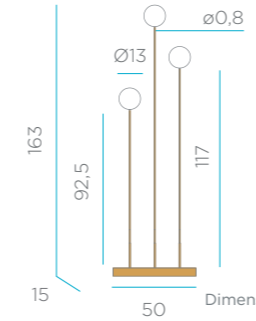

Dimensions (cm)

OPTIONS

Options	Im	REFERENCES
Cable Indoor & outdoor use Brass colour	115	LUMBRU165BROCWN

Packaging: 36 x 56,5 x 168 cm | Gross Weight (Packaged Weight): 3,9kg.

CANDELA

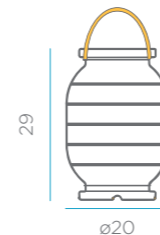

Dimensions (cm)

OPTIONS

Options	Im	REFERENCES
Rechargeable Battery Indoor & outdoor use	100	LUMCN030WLNW

Packaging: 20,5 x 20,5 x 29,5 cm | Gross Weight (Packaged Weight): 1,5kg | Vegan leather handle

FARALAY 30

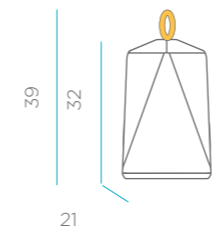

Dimensions (cm)

OPTIONS

Options	Im	REFERENCES
Solar & Rechargeable Battery Indoor & outdoor use	45	LUMFA033SSNW

Packaging: 22 x 22 x 32 cm | Gross Weight (Packaged Weight): 1,5kg | Vegan leather handle

GOA 40



Dimensions (cm)

OPTIONS

Options	Im	REFERENCES
Rechargeable Battery Indoor & outdoor use	315	LUMGA040WLNW
Cable Indoor & outdoor use	600	LUMGA040OFNW

Packaging: 29,5 x 25,7 x 41,6 cm | Gross Weight (Packaged Weight): 1,5kg.

GLOSSARY This technical catalogue is subject to periodic updates, the measurements or finishes may vary in future revisions.

☀️ White light (included) ☀️ Warm light (included) 🌈 RGB light (included) 🔋 Warm light portable rechargeable battery (included) 📡 LED Led tube lighting (included) 📡 Remote control (included)
 🌙 Twilight sensor 🖱️ Motion sensor 📊 Dimmable 📌 Hanging product 🚫 Floating, not submersible 🗣️ Integrated speakers 🖱️ Touch control 💧 Volume of the plantation area

IP Indicates the level of protection of the electrical or electronic equipment against the entry of external agents: dust or water.

GLOSSARY This technical catalogue is subject to periodic updates, the measurements or finishes may vary in future revisions.

☀️ White light (included) ☀️ Warm light (included) 🌈 RGB light (included) 🔋 Warm light portable rechargeable battery (included) 📡 LED Led tube lighting (included) 📡 Remote control (included)
 🌙 Twilight sensor 🖱️ Motion sensor 📊 Dimmable 📌 Hanging product 🚫 Floating, not submersible 🗣️ Integrated speakers 🖱️ Touch control 💧 Volume of the plantation area

IP Indicates the level of protection of the electrical or electronic equipment against the entry of external agents: dust or water.

GOA 70

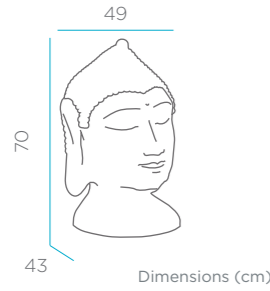

OPTIONS

Options	Im	REFERENCES
Rechargeable Battery Indoor & outdoor use	335	LUMGA070WLNW
Cable Indoor & outdoor use	600	LUMGA070OFNW

Packaging: 51 x 44 x 71 cm | Gross Weight (Packaged Weight): 5,7kg.

GUFO 40

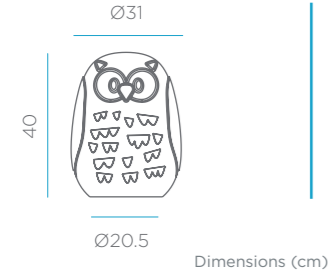

OPTIONS

Options	Im	REFERENCES
Solar & Rechargeable Battery Indoor & outdoor use	45	LUMGF040SSNW

Packaging: 31 x 31x 46,5 cm | Gross Weight (Packaged Weight): 2kg.

KAKTUS 100

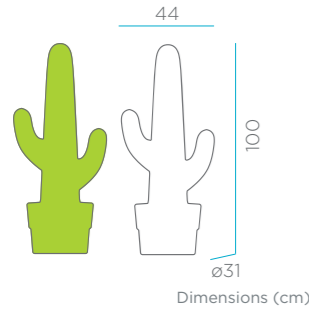

OPTIONS

Options	Im	REFERENCES
Rechargeable Battery Indoor & outdoor use	360	LUMKLI00TWLNW
Cable Indoor & outdoor use	1.400	LUMK1000FNW
Cable Indoor & outdoor use Lime colour.	1.400	LUMKLI000FNW

Packaging: 34,2 x 34,2 x 101 cm | Gross Weight (Packaged Weight): 3,7kg | Floor anchorage included.

KURBY 38

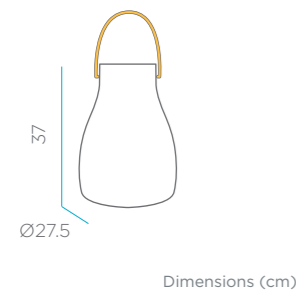

OPTIONS

Options	Im	REFERENCES
Solar & Rechargeable Battery Indoor & outdoor use	45	LUMKRO38SSNW

Packaging: 28 x 28 x 39 cm | Gross Weight (Packaged Weight): 1,8kg | Vegan leather handle

NÓMADA 30

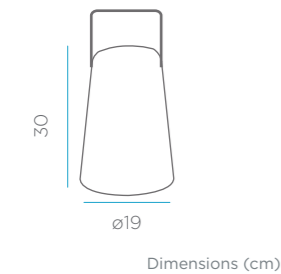

OPTIONS

Options	Im	REFERENCES
Solar & Rechargeable Battery Indoor & outdoor use	45	LUMNMO32SLNW

Packaging: 20 x 20 x 31 cm | Gross Weight (Packaged Weight): 1,3kg | Metal handle

SAMBA

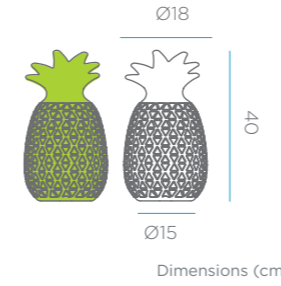

OPTIONS

Options	Im	REFERENCES
Rechargeable Battery Indoor & outdoor use	100	LUMSM040WLNW
Cable Indoor use	400	LUMSMV40ICNW
Cable Indoor use Lime colour.	400	LUMSMLV40ICNW

Packaging: 21,5 x 21,5 x 39,6 cm | Gross Weight (Packaged Weight): 1kg

SAONA 70

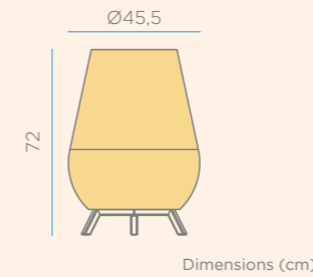

OPTIONS

Options	Im	REFERENCES
Rechargeable Battery Indoor & outdoor use	900	LUMSAO070XXWLNW
Cable Jute IN&OUT Indoor & outdoor use	290	LUMSAO070XXIONW

Packaging: 50,4 x 50,4 x 74 cm | Gross Weight (Packaged Weight): 3,5 kg / Cable Jute Gross Weight (Packaged Weight): 4 kg

NATURE COLLECTION

SISINE 70

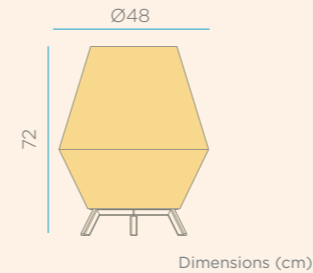

OPTIONS

Options	Im	REFERENCES
Rechargeable Battery Indoor & outdoor use	900	LUMSIS070XXWLNW
Cable Jute IN&OUT Indoor & outdoor use	290	LUMSIS070XXIONW

Packaging: 50,4 x 50,4 x 74 cm | Gross Weight (Packaged Weight): 3 kg / Cable Jute Gross Weight (Packaged Weight): 3,5 kg

NATURE COLLECTION

GARLANDS

ALLEGRA

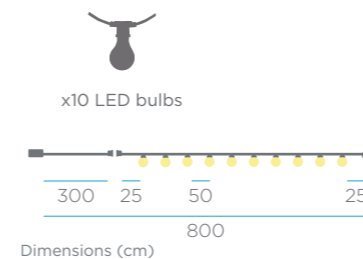

OPTIONS

Options	Im	REFERENCES
Solar + Rechargeable Battery Indoor & outdoor use Jute cable	35	LUMGASXXSLNW
Solar + Rechargeable Battery Indoor & outdoor use White cable	35	LUMGASBXXSLNW
Solar + Rechargeable Battery Indoor & outdoor use Black cable	35	LUMGASNXXSLNW
Cable Indoor & outdoor use Jute cable	35	LUMGASXXOCNW
Cable Indoor & outdoor use White cable	35	LUMGALLOCBXNW
Cable Indoor & outdoor use Pink cable	35	LUMGALLOCRNW
Cable Indoor & outdoor use Black cable	35	LUMGALLOCNNW
Cable Indoor & outdoor use Black cable	20	LUMGALLRGBNW

Dimensions (cm)
Packaging Solar + Rechargeable Batt: 28,5 x 15 x 15 cm, Gross Weight (Packaged Weight): 1,5 kg | Packaging Cable: 28,5 x 15 x 13 cm, Gross Weight (Packaged Weight): 0,9 kg (1,2 kg Jute Cable)
| Packaging Cable RGB: 28,5 x 15 x 12 cm, Gross Weight (Packaged Weight): 0,9 kg

AURORA

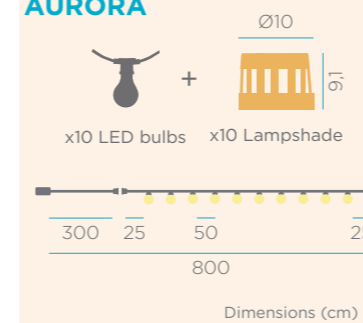

OPTIONS

Options	Im	REFERENCES
Solar + Rechargeable Battery Indoor & outdoor use Jute cable	35	LUMAUR800XXSLNW
Cable Indoor & outdoor use Jute cable	35	LUMAUR800XXOCNW

Packaging Solar + Rechargeable Battery: 21 x 30 x 15 cm | Gross Weight (Packaged Weight): 1,15kg / Packaging Cable: 21 x 25 x 15 cm
| Gross Weight (Packaged Weight): 0,8 kg

NATURE COLLECTION

GLOSSARY This technical catalogue is subject to periodic updates, the measurements or finishes may vary in future revisions.

☀ White light (included) ☀ Warm light (included) 🌈 RGB light (included) 🔋 Warm light portable rechargeable battery (included) 📶 LED Led tube lighting (included) 📶 Remote control (included)
🌙 Twilight sensor 🦋 Motion sensor 📶 Dimmable 📶 Hanging product 🌊 Floating, not submersible 🗣️ Integrated speakers 🖱️ Touch control 🌊 Volume of the plantation area

IP Indicates the level of protection of the electrical or electronic equipment against the entry of external agents: dust or water.

GLOSSARY This technical catalogue is subject to periodic updates, the measurements or finishes may vary in future revisions.

☀ White light (included) ☀ Warm light (included) 🌈 RGB light (included) 🔋 Warm light portable rechargeable battery (included) 📶 LED Led tube lighting (included) 📶 Remote control (included)
🌙 Twilight sensor 🦋 Motion sensor 📶 Dimmable 📶 Hanging product 🌊 Floating, not submersible 🗣️ Integrated speakers 🖱️ Touch control 🌊 Volume of the plantation area

IP Indicates the level of protection of the electrical or electronic equipment against the entry of external agents: dust or water.

STELLA

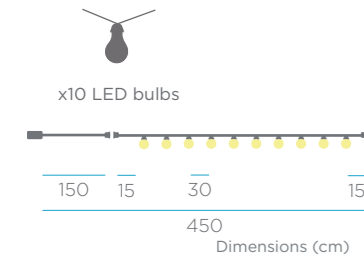

OPTIONS

- Solar + Rechargeable Battery | Indoor & outdoor use | Transparent cable 35
- Cable | Indoor & outdoor use | Transparent rope 35

Packaging Solar + Rechargeable Battery: 13 x 22 x 15 cm | Gross Weight (Packaged Weight): 0,6kg /
Packaging Cable: 12 x 20 x 17 cm | Gross Weight (Packaged Weight): 0,4kg

Im REFERENCES

- LUMGSTLSLNW
- LUMGSTLOCNW

PORTABLE HANG

BENIRRÁS

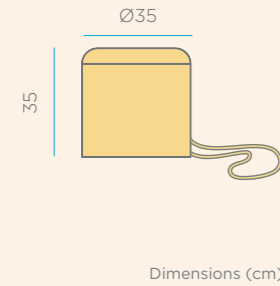

OPTIONS

- Rechargeable Battery | Indoor & outdoor use 900

Packaging: 34,4 x 34,4 x 38,1 cm | Gross Weight (Packaged Weight): 0,9kg | String: 300cm

Im REFERENCES

- LUMBEN035XXHXNW

NATURE COLLECTION

BITA

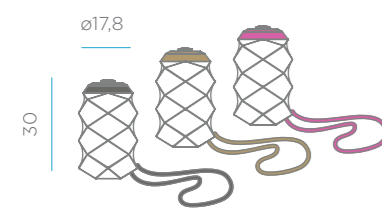

OPTIONS

- Rechargeable Battery | Indoor & outdoor use | ● (Anthracite) 300
- Rechargeable Battery | Indoor & outdoor use | ● (Pink rope) 300
- Rechargeable Battery | Indoor & outdoor use | ● (Beige rope) 300

Packaging: 18,5 x 18,5 x 29,5 cm | Gross Weight (Packaged Weight): 0,9kg | String: 150cm

Im REFERENCES

- LUMBITAWLNW
- LUMBITAR030WLNW
- LUMBITAB030WLNW

BOSSA HANG

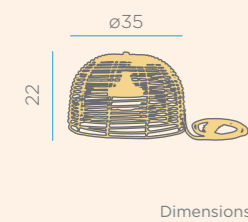

OPTIONS

- Rechargeable Battery | Indoor & outdoor use 900

Packaging: 38,4 x 38,4 x 19,8 cm | Gross Weight (Packaged Weight): 1,5kg | String: 300cm

Im REFERENCES

- LUMBOHXNW

NATURE COLLECTION

CALOBRA

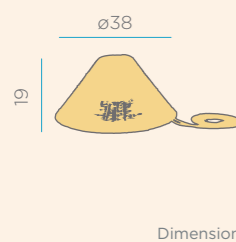

OPTIONS

- Rechargeable Battery | Indoor & outdoor use 900

Packaging: 38,4 x 38,4 x 19,8 cm | Gross Weight (Packaged Weight): 1,5kg | String: 300cm

Im REFERENCES

- LUMCAHXNW

NATURE COLLECTION

GLOSSARY This technical catalogue is subject to periodic updates, the measurements or finishes may vary in future revisions.

- White light (included)
- Warm light (included)
- RGB light (included)
- Warm light portable rechargeable battery (included)
- LED Led tube lighting (included)
- Remote control (included)
- Twilight sensor
- Motion sensor
- Dimmable
- Hanging product
- Floating, not submersible
- Integrated speakers
- Touch control
- Volume of the plantation area

IP Indicates the level of protection of the electrical or electronic equipment against the entry of external agents: dust or water.

CHIARA

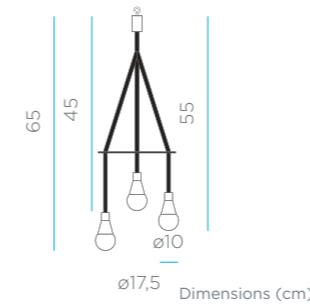

OPTIONS

- Solar & Rechargeable Battery | Indoor & outdoor use | ● Black colour 200x3

Packaging: 23,5 x 21,5 x 19 cm | Gross Weight (Packaged Weight): 0,7kg

Im REFERENCES

- LUMCHI065BXSXNW

ILARIA

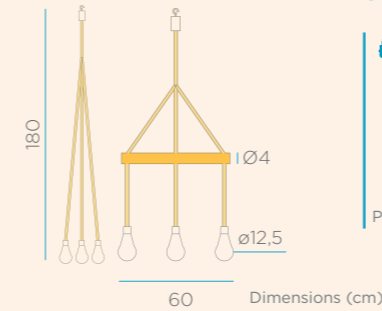

OPTIONS

- Solar & Rechargeable Battery Hang | Indoor & outdoor use 200x3

Packaging: 15 x 61 x 15 cm | Gross Weight (Packaged Weight): 2kg | Jute cable

Im REFERENCES

- LUMILA180XXSXNW

NATURE COLLECTION

NORAI

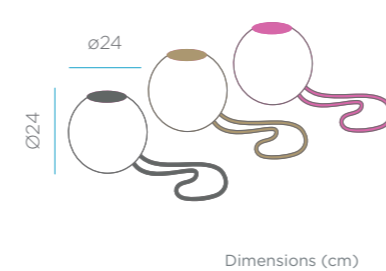

OPTIONS

- Rechargeable Battery | Indoor & outdoor use | ● (Anthracite) 300
- Rechargeable Battery | Indoor & outdoor use | ● (Pink rope) 300
- Rechargeable Battery | Indoor & outdoor use | ● (Beige rope) 300

Packaging: 24,6 x 24,6 x 24,6 cm | Gross Weight (Packaged Weight): 0,9kg | String: 150cm

Im REFERENCES

- LUMNR025WLNW
- LUMNRR025WLNW
- LUMNRB025WLNW

POSITANO

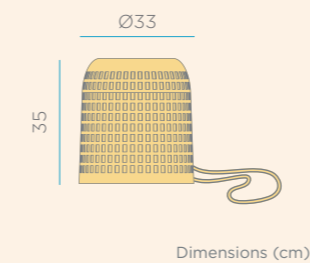

OPTIONS

- Rechargeable Battery | Indoor & outdoor use 900

Packaging: 34,4 x 34,4 x 38,1 cm | Gross Weight (Packaged Weight): 0,8kg | String: 300cm

Im REFERENCES

- LUMPOS035XXHXNW

NATURE COLLECTION

REONA

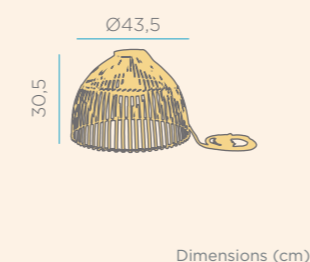

OPTIONS

- Rechargeable Battery | Indoor & outdoor use 900

Packaging: 31,65 x 43 x 43 cm | Gross Weight (Packaged Weight): 1,8kg | String: 300cm

Im REFERENCES

- LUMREHXNW

NATURE COLLECTION

GLOSSARY This technical catalogue is subject to periodic updates, the measurements or finishes may vary in future revisions.

- White light (included)
- Warm light (included)
- RGB light (included)
- Warm light portable rechargeable battery (included)
- LED Led tube lighting (included)
- Remote control (included)
- Twilight sensor
- Motion sensor
- Dimmable
- Hanging product
- Floating, not submersible
- Integrated speakers
- Touch control
- Volume of the plantation area

IP Indicates the level of protection of the electrical or electronic equipment against the entry of external agents: dust or water.

SAONA HANG

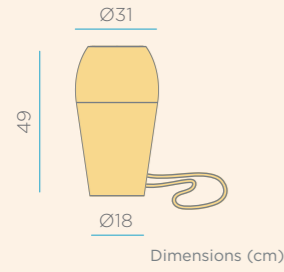

OPTIONS

- Rechargeable Battery | Indoor & outdoor use
 - IP54
 - 900
 - LUMSAO050XXHXNW
- Packaging: 32,8 x 32,8 x 51,5 cm | Gross Weight (Packaged Weight): 1,1kg | String: 300cm

Im REFERENCES

NATURE COLLECTION

SIMONA

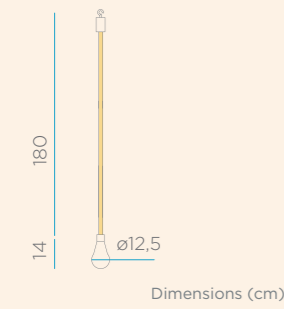

OPTIONS

- Solar & Rechargeable Battery Hang | Indoor & outdoor use
 - IP44
 - 200
 - LUMSIM180XXSWNW
- Packaging: 13,5 x 27 x 19,5 cm | Gross Weight (Packaged Weight): 0,6kg | Jute cable

Im REFERENCES

NATURE COLLECTION

SISINE HANG

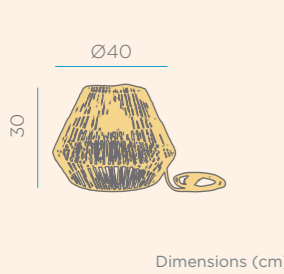

OPTIONS

- Rechargeable Battery | Indoor & outdoor use
 - IP54
 - 900
 - LUMSIHXNW
- Packaging: 31,65 x 43 x 43 cm | Gross Weight (Packaged Weight): 1,8kg | String: 300cm

Im REFERENCES

NATURE COLLECTION

SORA

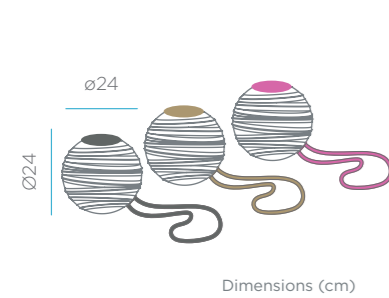

OPTIONS

- Rechargeable Battery | Indoor & outdoor use | (Anthracite)
 - Rechargeable Battery | Indoor & outdoor use | (Pink rope)
 - Rechargeable Battery | Indoor & outdoor use | (Beige rope)
 - IP65
 - 300
 - LUMSORAWLNLW
 - IP65
 - 300
 - LUMSORARWLNW
 - IP65
 - 300
 - LUMSORABWLNW
- Packaging: 24,6 x 24,6 x 24,6 cm | Gross Weight (Packaged Weight): 0,9kg | String: 150cm

Im REFERENCES

TABLE LAMPS

BOSSA 30

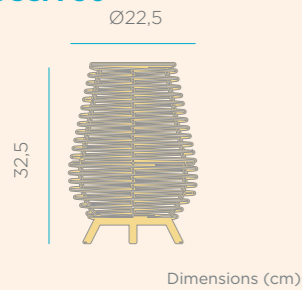

OPTIONS

- Rechargeable Battery | Indoor & outdoor use
 - IP54
 - 900
 - LUMBOS030XXWLNW
- Packaging: 27 x 27 x 40 cm | Gross Weight (Packaged Weight): 1,1kg

Im REFERENCES

NATURE COLLECTION

CARMEN 45

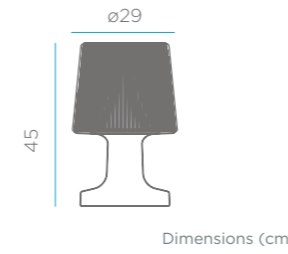

OPTIONS

- Rechargeable Battery | Indoor & outdoor use
 - Cable | Indoor use
 - IP65
 - IP20
 - 315
 - 600
 - LUMCRO45WLNW
 - LUMCRO45ICNW
- Packaging: 30,2 x 30,2 x 46,5 cm | Gross Weight (Packaged Weight): 2,3kg

Im REFERENCES

CHLOE 35

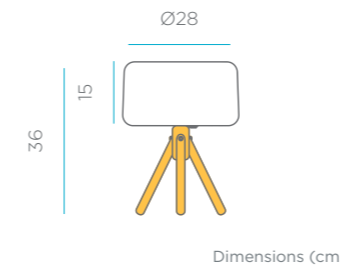

OPTIONS

- Solar & Rechargeable Battery | Indoor & outdoor use
 - Cable Jute | IN&OUT Indoor & outdoor use
 - IP65
 - IP44
 - 45
 - 500
 - LUMCHL035SSNW
 - LUMCHL035CCNW
- Packaging: 28,3 x 28,3 x 18 cm | Gross Weight (Packaged Weight): 1,8kg

Im REFERENCES

ENOKI



OPTIONS

- Rechargeable Battery | Indoor & outdoor use | White colour
 - Rechargeable Battery | Indoor & outdoor use | Black colour
 - IP44
 - IP44
 - 170
 - 170
 - LUMEN025BWLNLW
 - LUMEN025NWLNLW
- Packaging: 17 x 18,5 x 28 cm | Gross Weight (Packaged Weight): 1,1kg

Im REFERENCES

LOLA 20

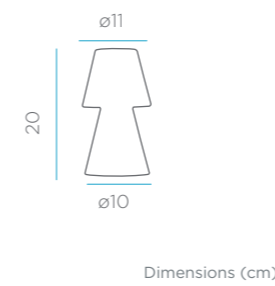

OPTIONS

- Rechargeable Battery | Indoor & outdoor use
 - *AAA Batteries | Indoor & outdoor use
 - * 3 AAA Batteries no supplies / Only smooth change colour mode
 - IP43
 - IP20
 - 18
 - 8
 - LUMLL020WLNW
 - LUMLL20AAANW
- Packaging: 10,6 x 10,6 x 20,6 cm | Gross Weight (Packaged Weight): 0,3kg

Im REFERENCES

LOLA 30

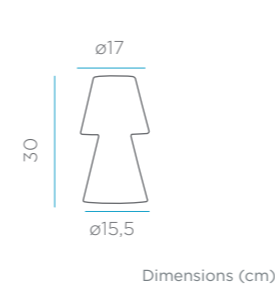

OPTIONS

- Rechargeable Battery | Indoor & outdoor use
 - Cable | Indoor & outdoor use
 - IP65
 - IP65
 - 315
 - 600
 - LUMLL030WLNW
 - LUMLL030OFNW
- Packaging: 17 x 17 x 31,6 cm | Gross Weight (Packaged Weight): 1,2kg

Im REFERENCES

GLOSSARY This technical catalogue is subject to periodic updates, the measurements or finishes may vary in future revisions.

White light (included)
 Warm light (included)
 RGB light (included)
 Warm light portable rechargeable battery (included)
 LED Led tube lighting (included)
 Remote control (included)
 Twilight sensor
 Motion sensor
 Dimmable
 Hanging product
 Floating, not submersible
 Integrated speakers
 Touch control
 Volume of the plantation area

IP Indicates the level of protection of the electrical or electronic equipment against the entry of external agents: dust or water.

GLOSSARY This technical catalogue is subject to periodic updates, the measurements or finishes may vary in future revisions.

White light (included)
 Warm light (included)
 RGB light (included)
 Warm light portable rechargeable battery (included)
 LED Led tube lighting (included)
 Remote control (included)
 Twilight sensor
 Motion sensor
 Dimmable
 Hanging product
 Floating, not submersible
 Integrated speakers
 Touch control
 Volume of the plantation area

IP Indicates the level of protection of the electrical or electronic equipment against the entry of external agents: dust or water.

LOLA 45

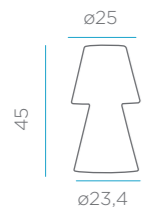

Dimensions (cm)

OPTIONS

- Rechargeable Battery | Indoor & outdoor use 360
- Cable | Indoor & outdoor use 600

Packaging: 26 x 26 x 48 cm | Gross Weight (Packaged Weight): 1,7kg

lm

REFERENCES

- LUMLL045WLNW
- LUMLL045OFNW

LOLA SLIM 30



Dimensions (cm)

OPTIONS

- Rechargeable Battery | Indoor & outdoor use 160
- Rechargeable Battery | Indoor & outdoor use 160
- Rechargeable Battery | Indoor & outdoor use 160
- Rechargeable Battery | Indoor & outdoor use 160
- Rechargeable Battery | Indoor & outdoor use 160
- Rechargeable Battery | Indoor & outdoor use 160
- Rechargeable Battery | Indoor & outdoor use 160

Packaging: 11,5 x 11,5 x 33,5 cm | Gross Weight (Packaged Weight): 0,9kg

lm

REFERENCES

- LUMLLS030ANWLNW
- LUMLLS030MNWLNW
- LUMLLS030BRWLNW
- LUMLLS030RGWLNW
- LUMLLS030GEWLNW
- LUMLLS030LIWLNW
- LUMLLS030BXWLNW

PANCHITO

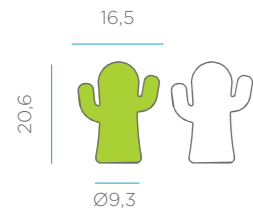

Dimensions (cm)

OPTIONS

- Rechargeable Battery | Indoor & outdoor use 11
- Rechargeable Battery | Indoor & outdoor use 11

Packaging: 15,6 x 10 x 21,5 cm | Gross Weight (Packaged Weight): 0,3kg.

lm

REFERENCES

- LUMPCT20WVLNW
- LUMPCT20VWLNW

ROCKET 20

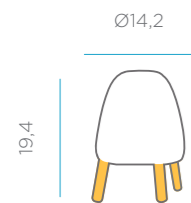

Dimensions (cm)

OPTIONS

- Rechargeable Battery | Indoor & outdoor use 11

Packaging: 13,5 x 13,5 x 14,5 cm | Gross Weight (Packaged Weight): 0,35kg.

lm

REFERENCES

- LUMRCK20WLNW

SAONA 30

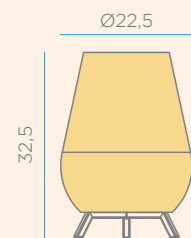

Dimensions (cm)

OPTIONS

- Rechargeable Battery | Indoor & outdoor use 900

Packaging: 27 x 27 x 40 cm | Gross Weight (Packaged Weight): 1,8kg

lm

REFERENCES

- LUMSAO030XXWLNW

NATURE COLLECTION

SISINE 30

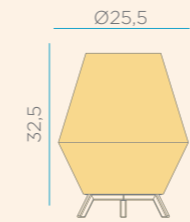

Dimensions (cm)

OPTIONS

- Rechargeable Battery | Indoor & outdoor use 900

Packaging: 27 x 27 x 40 cm | Gross Weight (Packaged Weight): 1,3kg

lm

REFERENCES

- LUMSIS030XXWLNW

NATURE COLLECTION

SPEAKERS

CUBY 45 PLAY

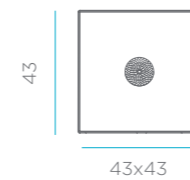

Dimensions (cm)

OPTIONS

- Rechargeable Battery | Play: Light & Music | Indoor & outdoor use 45

Packaging: 43,5 x 43,5 x 45 cm | Gross Weight (Packaged Weight): 5kg | x2 Speakers

lm

REFERENCES

- LUMCBP45WLNW

FARALAY 30 PLAY

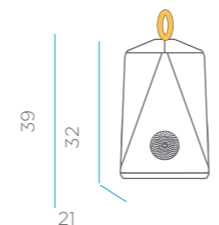

Dimensions (cm)

OPTIONS

- Rechargeable Battery | Play: Light & Music | Indoor & outdoor use 45

Packaging: 22 x 22 x 32 cm | Gross Weight (Packaged Weight): 1,5kg | Vegan leather handle | x1 Speaker

lm

REFERENCES

- LUMFA033PLNW

KURBY 38 PLAY

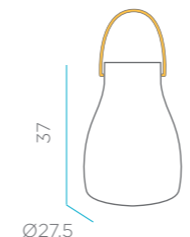

Dimensions (cm)

OPTIONS

- Rechargeable Battery | Play: Light & Music | Indoor & outdoor use 45

Packaging: 37 x 27,5 x 27,5 cm | Gross Weight (Packaged Weight): 1,8kg | Vegan leather handle | x1 Speaker

lm

REFERENCES

- LUMKRO38PLNW

GLOSSARY This technical catalogue is subject to periodic updates, the measurements or finishes may vary in future revisions.

White light (included) Warm light (included) RGB light (included) Warm light portable rechargeable battery (included) LED Led tube lighting (included) Remote control (included) Twilight sensor Motion sensor Dimmable Hanging product Floating, not submersible Integrated speakers Touch control Volume of the plantation area

IP Indicates the level of protection of the electrical or electronic equipment against the entry of external agents: dust or water.

GLOSSARY This technical catalogue is subject to periodic updates, the measurements or finishes may vary in future revisions.

White light (included) Warm light (included) RGB light (included) Warm light portable rechargeable battery (included) LED Led tube lighting (included) Remote control (included) Twilight sensor Motion sensor Dimmable Hanging product Floating, not submersible Integrated speakers Touch control Volume of the plantation area

IP Indicates the level of protection of the electrical or electronic equipment against the entry of external agents: dust or water.

NIPPER PLAY

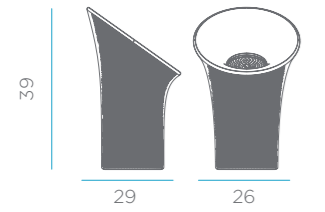

Dimensions (cm)

OPTIONS

Rechargeable Battery | Play: Light & Music | Indoor & outdoor use 25

Packaging: 27 x 24 x 40,6 cm | Gross Weight (Packaged Weight): 1,5kg | x1 Speaker

lm

REFERENCES

LUMNP040PLNW

NÓMADA 30 PLAY

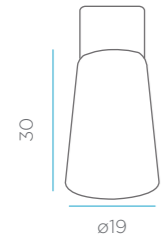

Dimensions (cm)

OPTIONS

Rechargeable Battery | Play: Light & Music | Indoor & outdoor use 45

Packaging: 20 x 20 x 31 cm | Gross Weight (Packaged Weight): 1,3kg | Metal handle | x1 Speaker

lm

REFERENCES

LUMNM032PLNW

FUNCTIONAL

BALBY HANG

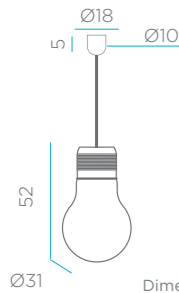

Dimensions (cm)

OPTIONS

Hanging Cable | Indoor & outdoor use -

Packaging: 35 x 35 x 55 cm | Gross Weight (Packaged Weight): 2,5kg | Metal trim | Cable: 1,5m | Installation required.

lm

REFERENCES

LUMBB030HXNW

BULY 20 WALL

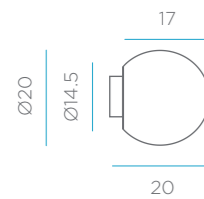

Dimensions (cm)

OPTIONS

Wall Cable | Indoor & outdoor use -

Packaging: 20,6x 20,6 x 22,3 cm | Gross Weight (Packaged Weight): 1kg | Installation required.

lm

REFERENCES

LUMBL020OPNW

BULY 30 HANG

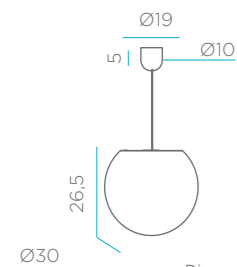

Dimensions (cm)

OPTIONS

Hanging Cable | Indoor & outdoor use x

Packaging: 31,5 x 31,5 x 29,5 cm | Gross Weight (Packaged Weight): 1,6kg | Metal trim | Cable: 1,5m | Installation required.

lm

REFERENCES

LUMBL030HXNW

CAPSULA TERPE 30 WALL

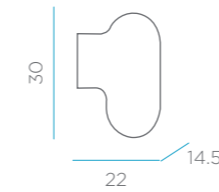

Dimensions (cm)

OPTIONS

Wall Cable | Indoor & outdoor use -

Packaging: 22,5 x 14,5 x 30,3 cm | Gross Weight (Packaged Weight): 1,6kg | Installation required.

lm

REFERENCES

LUMCP030OPNW

CHERRY BULB

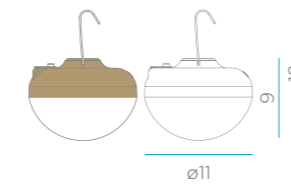

Dimensions (cm)

OPTIONS

Rechargeable Battery | Indoor & outdoor use White colour. 900
 Rechargeable Battery | Indoor & outdoor use Beige colour. 900

Packaging: 11,5 x 11 x 9 cm | Gross Weight (Packaged Weight): 0,3kg | Magnetic surface.

lm

REFERENCES

LUMCHE011BXWLNW

LUMCHE011BEWLNW

CLAUDY HANG

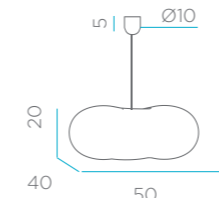

Dimensions (cm)

OPTIONS

Hanging Cable | Indoor & outdoor use -

Packaging: 39,5 x 50,3 x 20 cm | Gross Weight (Packaged Weight): 2,3kg | Cable: 1,5m | Installation required.

lm

REFERENCES

LUMCLO50HXNW

CUBY 20 WALL

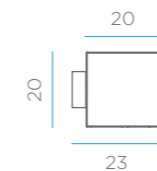

Dimensions (cm)

OPTIONS

Wall Cable | Indoor & outdoor use -

Packaging: 20,9x 20,9 x 24,6 cm | Gross Weight (Packaged Weight): 1,6kg | Installation required.

lm

REFERENCES

LUMCB020OPNW

GRETA

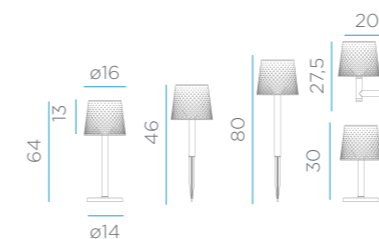

Dimensions (cm)

OPTIONS

Solar & Rechargeable Battery | Indoor & outdoor use White colour. 100
 Solar & Rechargeable Battery | Indoor & outdoor use Black colour. 100

Packaging: 23,5 x 22 x 16,5 cm | Gross Weight (Packaged Weight): 0,7kg | Recycled plastic

lm

REFERENCES

LUMGRE080BXSNNW

LUMGRE080NXSNNW

GLOSSARY This technical catalogue is subject to periodic updates, the measurements or finishes may vary in future revisions.

White light (included) Warm light (included) RGB light (included) Warm light portable rechargeable battery (included) Led tube lighting (included) Remote control (included)
 Twilight sensor Motion sensor Dimmable Hanging product Floating, not submersible Integrated speakers Touch control Volume of the plantation area

IP Indicates the level of protection of the electrical or electronic equipment against the entry of external agents: dust or water.

GLOSSARY This technical catalogue is subject to periodic updates, the measurements or finishes may vary in future revisions.

White light (included) Warm light (included) RGB light (included) Warm light portable rechargeable battery (included) Led tube lighting (included) Remote control (included)
 Twilight sensor Motion sensor Dimmable Hanging product Floating, not submersible Integrated speakers Touch control Volume of the plantation area

IP Indicates the level of protection of the electrical or electronic equipment against the entry of external agents: dust or water.

LOLA 35 WALL

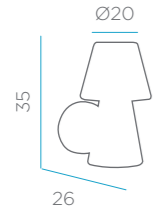

Dimensions (cm)

OPTIONS

Wall Cable | Indoor & outdoor use IP44

Packaging: 20,3x 36 x 36,5 cm | Gross Weight (Packaged Weight): 1,6kg | Installation required.

Im REFERENCES

- LUMLL035OPNW

PAQUITA 40

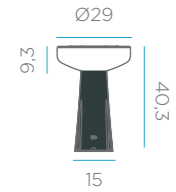

Dimensions (cm)

OPTIONS

Solar | Outdoor use Anthracite colour. IP65 600

Packaging: 15,2 x 40,3 x 32,5 cm | Gross Weight (Packaged Weight): 2,4kg

Im REFERENCES

LUMPQTSMSLNW

PAQUITA 215 FAROLA



Dimensions (cm)

OPTIONS

Solar | Outdoor use Anthracite colour. IP65 1.200

Packaging: 42,5 x 59,3 x 105 cm | Gross Weight (Packaged Weight): 12,8kg

Im REFERENCES

LUMPQTFARSLNW

PAQUITA WALL

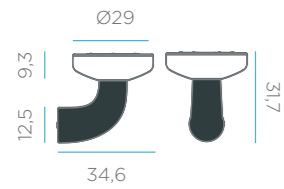

Dimensions (cm)

OPTIONS

Solar | Outdoor use Anthracite colour. IP65 600

Packaging: 22,3 x 29,7 x 29,8 cm | Gross Weight (Packaged Weight): 1,8kg

Im REFERENCES

LUMPQTAPLSLNW

PEPITA 45

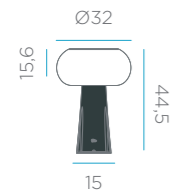

Dimensions (cm)

OPTIONS

Cable & Solar (Hibryd) | Outdoor use Anthracite colour. IP65 750

Packaging: 36 x 54 x 32,5 cm | Gross Weight (Packaged Weight): 2,5kg | Installation required.

Im REFERENCES

LUMPEP045ANSHNW

PEPITA 215 FAROLA



Dimensions (cm)

OPTIONS

Cable & Solar (Hibryd) | Outdoor use Anthracite colour. IP65 1.500

Packaging: 57 x 59,3 x 105 cm | Gross Weight (Packaged Weight): 13kg | Installation required.

Im REFERENCES

LUMPEP215ANSHNW

PEPITA WALL

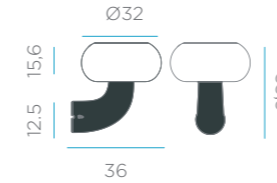

Dimensions (cm)

OPTIONS

Cable & Solar (Hibryd) | Outdoor use Anthracite colour. IP65 750

Packaging: 18,3 x 46,6 x 32,5 cm | Gross Weight (Packaged Weight): 2,5kg | Installation required.

Im REFERENCES

LUMPEP036ANOPNW

PETRA 40 HANG

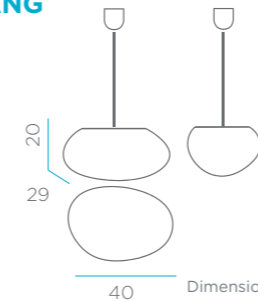

Dimensions (cm)

OPTIONS

Hanging Cable | Indoor & outdoor use IP44 -

Packaging: 40,3 x 29,5 x 20,5 cm | Gross Weight (Packaged Weight): 1,5kg | Metal trim | Cable: 1,5m | Installation required.

Im REFERENCES

LUMPT040HXNW

PETRA 60 HANG

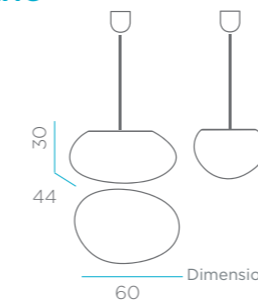

Dimensions (cm)

OPTIONS

Hanging Cable | Indoor & outdoor use IP44 -

Packaging: 44,3 x 60,2 x 30,8 cm | Gross Weight (Packaged Weight): 2,5kg | Metal trim | Cable: 1,5m | Installation required.

Im REFERENCES

LUMPT060HXNW

SISINE 25 WALL

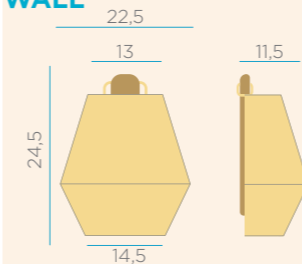

Dimensions (cm)

OPTIONS

Rechargeable Battery | Indoor & outdoor use IP54 900

Packaging: 27,2 x 21,2 x 16,3 cm | Gross Weight (Packaged Weight): 0,9kg

Im REFERENCES

LUMSIS025XXWLNW

NATURE COLLECTION

GLOSSARY This technical catalogue is subject to periodic updates, the measurements or finishes may vary in future revisions.

White light (included) Warm light (included) RGB light (included) Warm light portable rechargeable battery (included) LED Tube Led tube lighting (included) Remote control (included) Twilight sensor Motion sensor Dimmable Hanging product Floating, not submersible Integrated speakers Touch control Volume of the plantation area

IP Indicates the level of protection of the electrical or electronic equipment against the entry of external agents: dust or water.

GLOSSARY This technical catalogue is subject to periodic updates, the measurements or finishes may vary in future revisions.

White light (included) Warm light (included) RGB light (included) Warm light portable rechargeable battery (included) LED Tube Led tube lighting (included) Remote control (included) Twilight sensor Motion sensor Dimmable Hanging product Floating, not submersible Integrated speakers Touch control Volume of the plantation area

IP Indicates the level of protection of the electrical or electronic equipment against the entry of external agents: dust or water.

ESSENTIALS

BULY 20

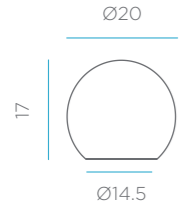

Dimensions (cm)

OPTIONS

- Solar & Rechargeable Battery | Indoor & outdoor use (Floating)
- Solar | outdoor use
- Cable | Indoor & outdoor use

Packaging: 19,5 x 20,3 x 20,3 cm | Gross Weight (Packaged Weight): 0,8kg.

lm	REFERENCES
45	LUMBL020FTNW
16	LUMBL020SANW
250	LUMBL020OFNW

BULY 30

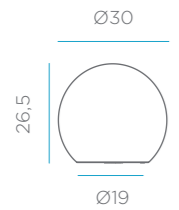

Dimensions (cm)

OPTIONS

- Solar & Rechargeable Battery | Indoor & outdoor use (Floating)
- Cable | Indoor & outdoor use

Packaging: 31,5 x 31,5 x 29 cm | Gross Weight (Packaged Weight): 1,2kg.

lm	REFERENCES
45	LUMBL030FTNW
600	LUMBL030OFNW

BULY 40

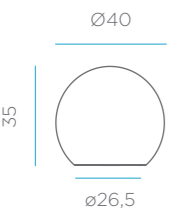

Dimensions (cm)

OPTIONS

- Solar & Rechargeable Battery | Indoor & outdoor use (Floating)
- Solar & Rechargeable Battery | Indoor & outdoor use
- Cable | Indoor & outdoor use

Packaging: 36,6 x 40,3 x 40,3 cm | Gross Weight (Packaged Weight): 1,9kg.

lm	REFERENCES
45	LUMBL040FTNW
45	LUMBL040SSNW
600	LUMBL040OFNW

BULY 50

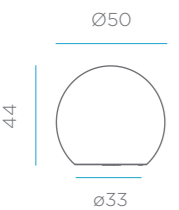

Dimensions (cm)

OPTIONS

- Solar & Rechargeable Battery | Indoor & outdoor use
- Cable | Indoor & outdoor use

Packaging: 44,5 x 50,5 x 50,5 cm | Gross Weight (Packaged Weight): 3,2kg.

lm	REFERENCES
45	LUMBL050SSNW
600	LUMBL050OFNW

BULY 60

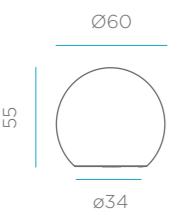

Dimensions (cm)

OPTIONS

- Solar & Rechargeable Battery | Indoor & outdoor use
- Cable | Indoor & outdoor use

Packaging: 56 x 59,5 x 59,5 cm | Gross Weight (Packaged Weight): 4,5kg.

lm	REFERENCES
45	LUMBL060SSNW
600	LUMBL060OFNW

BULY 80

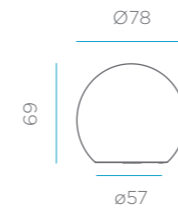

Dimensions (cm)

OPTIONS

- Solar & Rechargeable Battery | Indoor & outdoor use
- Cable | Indoor & outdoor use

Packaging: 70,3 x 79,5 x 79,5 cm | Gross Weight (Packaged Weight): 9,5kg.

lm	REFERENCES
600	LUMBL080SSNW
600	LUMBL080OFNW

CUBY 20

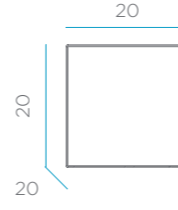

Dimensions (cm)

OPTIONS

- Solar & Rechargeable Battery | Indoor & outdoor use
- Cable | Indoor & outdoor use

Packaging: 26,5 x 30,3 x 30,3 cm | Gross Weight (Packaged Weight): 1,1kg.

lm	REFERENCES
45	LUMCB020SSNW
250	LUMCB020OFNW

CUBY 32

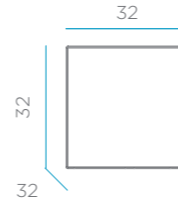

Dimensions (cm)

OPTIONS

- Solar & Rechargeable Battery | Indoor & outdoor use
- Cable | Indoor & outdoor use

Packaging: 34,8 x 32,5 x 32,5 cm | Gross Weight (Packaged Weight): 2,7kg.

lm	REFERENCES
45	LUMCB032SSNW
600	LUMCB032OFNW

CUBY 40

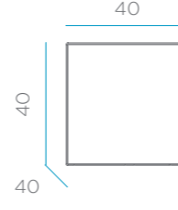

Dimensions (cm)

OPTIONS

- Solar & Rechargeable Battery | Indoor & outdoor use
- Cable | Indoor & outdoor use

Packaging: 46,6 x 46,6 x 42 cm | Gross Weight (Packaged Weight): 4kg.

lm	REFERENCES
45	LUMCB040SSNW
600	LUMCB040OFNW

CUBY 45

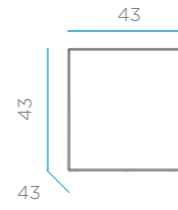

Dimensions (cm)

OPTIONS

- Solar & Rechargeable Battery | Indoor & outdoor use
- Cable | Indoor & outdoor use

Packaging: 45 x 43,5 x 43,5 cm | Gross Weight (Packaged Weight): 5kg.

lm	REFERENCES
45	LUMCB045SSNW
600	LUMCB045OFNW

GLOSSARY This technical catalogue is subject to periodic updates, the measurements or finishes may vary in future revisions.

- White light (included)
- Warm light (included)
- RGB light (included)
- Warm light portable rechargeable battery (included)
- LED Led tube lighting (included)
- Remote control (included)
- Twilight sensor
- Motion sensor
- Dimmable
- Hanging product
- Floating, not submersible
- Integrated speakers
- Touch control
- Volume of the plantation area

IP Indicates the level of protection of the electrical or electronic equipment against the entry of external agents: dust or water.

GLOSSARY This technical catalogue is subject to periodic updates, the measurements or finishes may vary in future revisions.

- White light (included)
- Warm light (included)
- RGB light (included)
- Warm light portable rechargeable battery (included)
- LED Led tube lighting (included)
- Remote control (included)
- Twilight sensor
- Motion sensor
- Dimmable
- Hanging product
- Floating, not submersible
- Integrated speakers
- Touch control
- Volume of the plantation area

IP Indicates the level of protection of the electrical or electronic equipment against the entry of external agents: dust or water.

CUBY 53

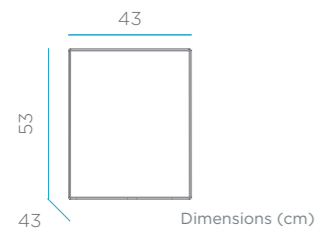

OPTIONS

- Solar & Rechargeable Battery | Indoor & outdoor use
 - Cable | Indoor & outdoor use
- Packaging: 43,6x 43,6 x 55 cm | Gross Weight (Packaged Weight): 5,5kg.

Im REFERENCES

- 45 LUMCB053SSNW
- 600 LUMCB053OFNW

PETRA 40

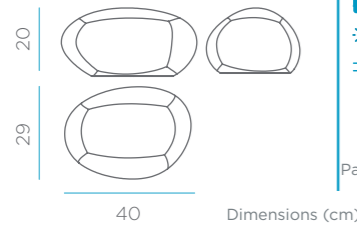

OPTIONS

- Solar & Rechargeable Battery | Indoor & outdoor use
 - Solar | Outdoor use
 - Cable | Indoor & outdoor use
- Packaging: 20,5 x 40,3 x 29,5 cm | Gross Weight (Packaged Weight): 1,3kg.

Im REFERENCES

- 45 LUMPT040SSNW
- 16 LUMPT040SANW
- 250 LUMPT040OFNW

PETRA 60

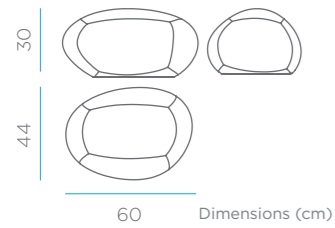

OPTIONS

- Solar & Rechargeable Battery | Indoor & outdoor use
 - Cable | Indoor & outdoor use
- Packaging: 44,3 x 60,2 x 30,8 cm | Gross Weight (Packaged Weight): 2,5kg.

Im REFERENCES

- 45 LUMPT060SSNW
- 600 LUMPT060OFNW

FURNITURE

TABLES P 190

SEATS P 192

BAR P 195

TABLES

BORA

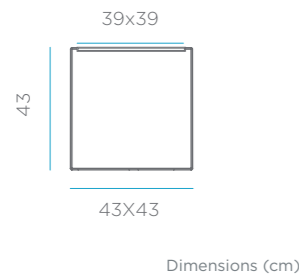

OPTIONS

- Cable Jute | IN&OUT Indoor & outdoor use | Marble
 - Cable Jute | IN&OUT Indoor & outdoor use | Wood
- White Opaque Colour | Marble
- White Opaque Colour | Wood
- Packaging: 44 x 44 x 45,5 cm | Gross Weight (Packaged Weight) Wood: 5,7 kg | Gross Weight (Packaged Weight) Marble: 8,2 kg

Im REFERENCES

- 860 LUMBORAMBXINOUTNW
- 860 LUMBORAWBXINOUTNW
- LUMBORAMBXNW
- LUMBORAWBXNW

CAPRI 40

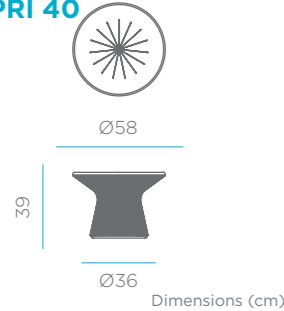

OPTIONS

- Solar & Rechargeable Battery | Indoor & outdoor use
- White Opaque Colour
- Packaging: 60 x 60x 42cm | Gross Weight (Packaged Weight): 4,5 kg | Methacrylate cover included.

Im REFERENCES

- 45 MOBCP040SSNW
- MOBCP040BXNW

CAPRI 75

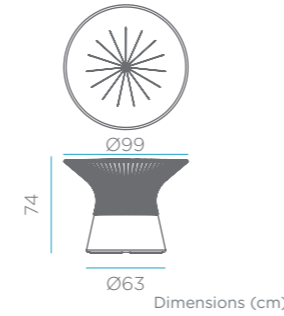

OPTIONS

- Solar & Rechargeable Battery | Indoor & outdoor use
 - Cable | Indoor & outdoor use
- White Opaque Colour
- Packaging: Plastic bag | Gross Weight (Packaged Weight): 18 kg | Methacrylate cover included.

Im REFERENCES

- 45 MOBCP075SSNW
- 600 MOBCP075OFNW
- MOBCP075BXNW

CAPRI 110

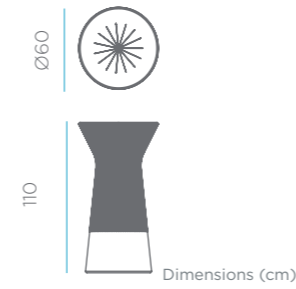

OPTIONS

- Rechargeable Battery | Indoor & outdoor use
- White Opaque Colour
- Packaging: 60 x 60 x 113cm | Gross Weight (Packaged Weight): 10 kg | Methacrylate cover included.

Im REFERENCES

- 360 MOBCP110WLNW
- MOBCP110BXNW

CUBY 45

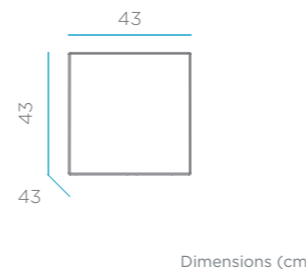

OPTIONS

- Solar & Rechargeable Battery | Indoor & outdoor use
 - Cable | Indoor & outdoor use
 - Rechargeable Battery | Play: Light & Music | Indoor & outdoor use
- Packaging: 45 x 43,5 x 43,5 cm | Gross Weight (Packaged Weight): 5kg.

Im REFERENCES

- 45 LUMCB045SSNW
- 600 LUMCB045OFNW
- 45 LUMCBP45WLNW

CUBY 53

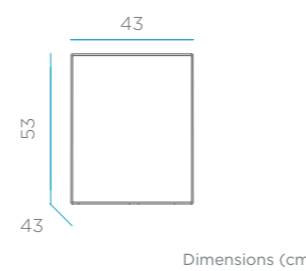

OPTIONS

- Solar & Rechargeable Battery | Indoor & outdoor use
 - Cable | Indoor & outdoor use
- Packaging: 43,6x 43,6 x 55 cm | Gross Weight (Packaged Weight): 5,5kg.

Im REFERENCES

- 45 LUMCB053SSNW
- 600 LUMCB053OFNW

ITACA 60

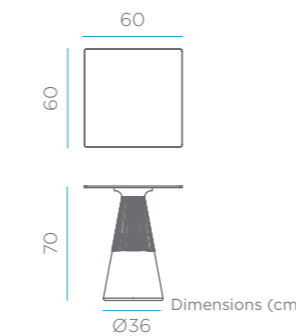

OPTIONS

- Solar & Rechargeable Battery | Indoor & outdoor use
- Packaging: 35,5 x 35,5 x 70 cm | Gross Weight (Packaged Weight): 12,6kg | White phenolic cover included. Unassembled. Weight stability included. Individual package. Tabletop plastic bag

Im REFERENCES

- 45 MOBITC60SSNW

GLOSSARY This technical catalogue is subject to periodic updates, the measurements or finishes may vary in future revisions.

- White light (included)
- Warm light (included)
- RGB light (included)
- Remote control (included)
- Twilight sensor
- Motion sensor
- LED tube lighting (included)
- Dimmable
- Hanging product
- Floating, not submersible
- Integrated speakers
- Touch control
- Volume of the plantation area

GLOSSARY This technical catalogue is subject to periodic updates, the measurements or finishes may vary in future revisions.

- White light (included)
 - Warm light (included)
 - RGB light (included)
 - Warm light portable rechargeable battery (included)
 - LED tube lighting (included)
 - Remote control (included)
 - Twilight sensor
 - Motion sensor
 - Dimmable
 - Hanging product
 - Floating, not submersible
 - Integrated speakers
 - Touch control
 - Volume of the plantation area
- IP Indicates the level of protection of the electrical or electronic equipment against the entry of external agents: dust or water.

MARTINICA

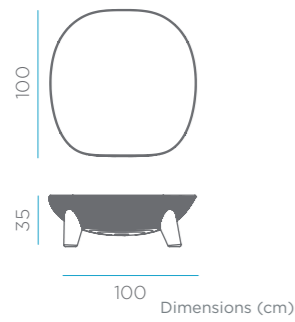

OPTIONS

- Solar & Rechargeable Battery | Indoor & outdoor use 45 MOBMESSASSNW
- White Opaque Colour MOBMESSABXNW

Packaging: Plastic bag | Gross Weight (Packaged Weight): 10kg

Im REFERENCES

MELVIN

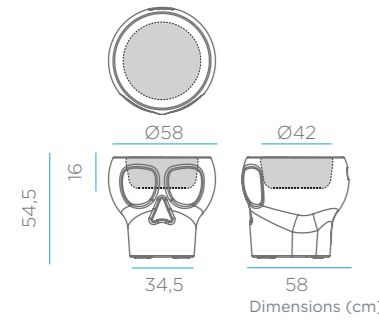

OPTIONS

- Solar & Rechargeable Battery | Indoor & outdoor use 45 MOBMV055SSNW
- White Opaque Colour MOBMV055BWNW

Packaging: 59 x 59 x 59cm | Gross Weight (Packaged Weight): 6kg | Methacrylate cover included. 23,9 L

Im REFERENCES

TARIDA TAB

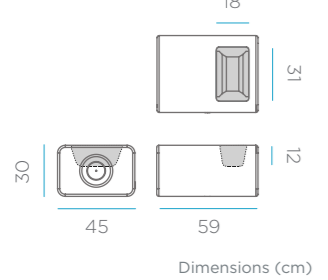

OPTIONS

- Solar & Rechargeable Battery | Indoor & outdoor use 45 MOBTD30SSNW
- Rechargeable Battery | Play: Light & Music | Indoor & outdoor use 45 MOBTD30PLNW
- White Opaque Colour MOBTD30BXNW

Packaging: Plastic bag | Gross Weight (Packaged Weight): 5kg | Methacrylate cover included. 3,5 L | Play Light & Music finished x2 Speakers.

Im REFERENCES

SEATS

ARUBA

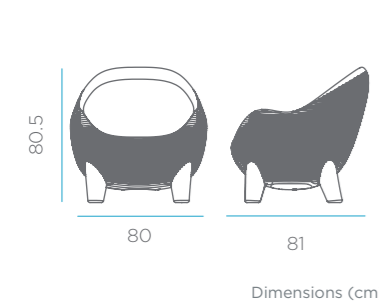

OPTIONS

- Solar & Rechargeable Battery | Indoor & outdoor use 45 MOBSILARSSNW
- White Opaque Colour MOBSILARBXNW

Packaging: Plastic bag | Gross Weight (Packaged Weight): 12kg

Im REFERENCES

CALVIN

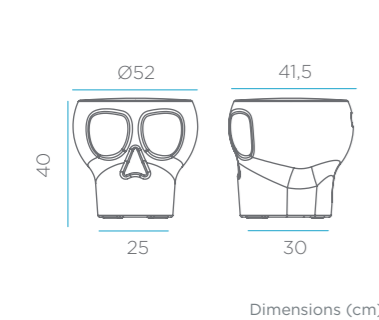

OPTIONS

- Solar & Rechargeable Battery | Indoor & outdoor use 45 MOBCV040SSNW
- Rechargeable Battery | Play: Light & Music | Indoor & outdoor use 45 MOBCV040PLNW
- White Opaque Colour MOBCV040BXNW

Packaging: 46 x 46 x 46,5cm | Gross Weight (Packaged Weight): 3 kg | Play Light & Music finished x1 Speaker.

Im REFERENCES

CORFU 40

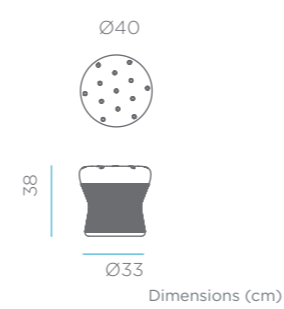

OPTIONS

- Solar & Rechargeable Battery | Indoor & outdoor use 45 MOBFC040SSNW
- White Opaque Colour MOBFC040BXNW

Packaging: 40,5 x 40,5 x 38 | Gross Weight (Packaged Weight): 3,5kg

Im REFERENCES

CORFU 74

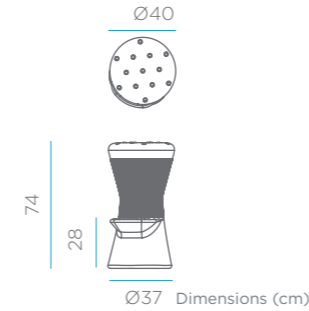

OPTIONS

- Solar & Rechargeable Battery | Indoor & outdoor use 45 MOBFC074SSNW
- White Opaque Colour MOBFC074BXNW

Packaging: 40 x 40 x 74,8 cm | Gross Weight (Packaged Weight): 5,5kg

Im REFERENCES

FORMENTERA

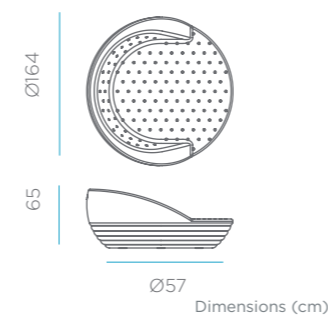

OPTIONS

- Solar & Rechargeable Battery | Indoor & outdoor use 45x4 MOBFR160SSNW
- Cable | Indoor & outdoor use 600 MOBFR160OFNW
- White Opaque Colour MOBFR160BXNW

White Formentera mattress 140 x 112 x 8 cm MOBFCNF140BXNLNW
 White Formentera pillow 50 x 50 cm MOBCNC050BXNLNW
 White Formentera pillow 60 x 40 cm MOBCNR060BXNLNW

Packaging: Plastic bag | Gross Weight (Packaged Weight): 41kg

Im REFERENCES

JAMAICA

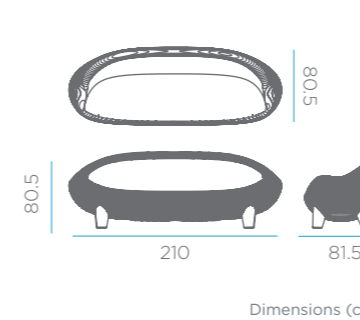

OPTIONS

- Solar & Rechargeable Battery | Indoor & outdoor use 45 MOBSOFJASSNW
- Cable | Indoor & outdoor use 600 MOBSOFJAOFNW
- White Opaque Colour MOBSOFJABXNW

Packaging: Plastic bag | Gross Weight (Packaged Weight): 30,5kg

Im REFERENCES

MALLORCA

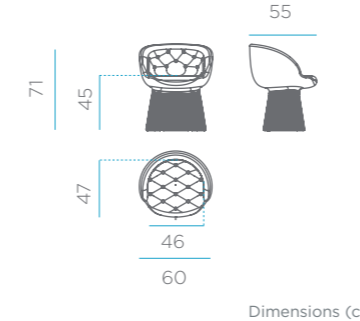

OPTIONS

- Solar & Rechargeable Battery | Indoor & outdoor use 45 MOBMA060SSNW
- White Opaque Colour MOBMA060BXNW

Packaging: 60 x 60 x 73cm | Gross Weight (Packaged Weight): 7,5kg

Im REFERENCES

GLOSSARY This technical catalogue is subject to periodic updates, the measurements or finishes may vary in future revisions.

White light (included) Warm light (included) RGB light (included) Warm light portable rechargeable battery (included) Led tube lighting (included) Remote control (included)
 Twilight sensor Motion sensor Dimmable Hanging product Floating, not submersible Integrated speakers Touch control Volume of the plantation area

IP Indicates the level of protection of the electrical or electronic equipment against the entry of external agents: dust or water.

GLOSSARY This technical catalogue is subject to periodic updates, the measurements or finishes may vary in future revisions.

White light (included) Warm light (included) RGB light (included) Warm light portable rechargeable battery (included) Led tube lighting (included) Remote control (included)
 Twilight sensor Motion sensor Dimmable Hanging product Floating, not submersible Integrated speakers Touch control Volume of the plantation area

IP Indicates the level of protection of the electrical or electronic equipment against the entry of external agents: dust or water.

PUFY 45

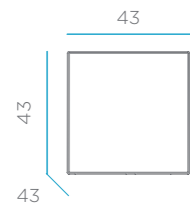

Dimensions (cm)

OPTIONS

White Opaque Colour ○

Packaging: 45 x 43,5 x 43,5 cm | Gross Weight (Packaged Weight): 5kg.

REFERENCES

MOBPF045BXNW

RASA

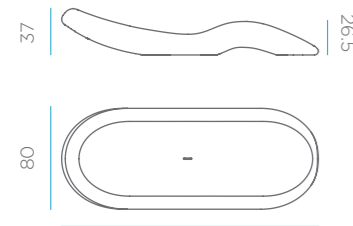

203
Dimensions (cm)

OPTIONS

White Opaque Colour ○

Packaging: Plastic bag | Gross Weight (Packaged Weight): 15kg

REFERENCES

MOBRASABXNW

TAFY 38

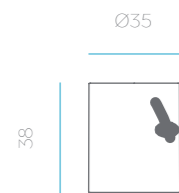

Dimensions (cm)

OPTIONS

White Opaque Colour ○

Black Opaque Colour ●

Packaging: 41,5 x 41,5 x 41 cm | Gross Weight (Packaged Weight): 2,8kg.

REFERENCES

MOBTF038BXNW

MOBTF038NXNW

TARIDA SIT

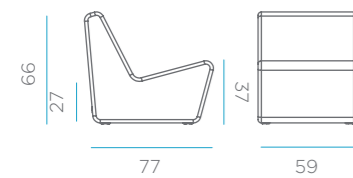

Dimensions (cm)

OPTIONS

Solar & Rechargeable Battery | Indoor & outdoor use IP65 Dimmable Motion sensor

Packaging: Plastic bag | Gross Weight (Packaged Weight): 8,5kg | Pillow included.

REFERENCES

600 MOBTDS66SSNW

TARIDA SIT ARMS

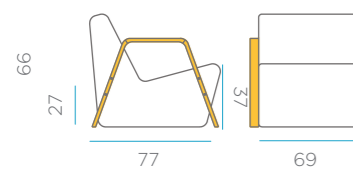

Dimensions (cm)

OPTIONS

Solar & Rechargeable Battery | Indoor & outdoor use IP65 Dimmable Motion sensor

White Opaque Colour ○

Packaging: 69 x 77 x 66,5 cm | Gross Weight (Packaged Weight): 14kg | Wood arms. | Pillow included.

REFERENCES

600 MOBTDS66ARMSSNW

MOBTDS66ARMBXNW

GLOSSARY This technical catalogue is subject to periodic updates, the measurements or finishes may vary in future revisions.

White light (included) Warm light (included) RGB light (included) Warm light portable rechargeable battery (included) LED Led tube lighting (included) Remote control (included) Twilight sensor Motion sensor Dimmable Hanging product Floating, not submersible Integrated speakers Touch control Volume of the plantation area

IP Indicates the level of protection of the electrical or electronic equipment against the entry of external agents: dust or water.

BAR

BRICKY

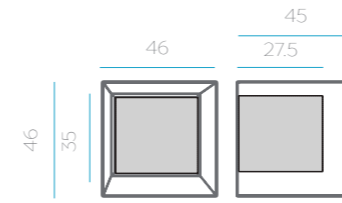

Dimensions (cm)

OPTIONS

Cable | Indoor & outdoor use IP44 Dimmable

White Opaque Colour ○

Packaging: 47,5 x 47,5 x 46,5 cm | Gross Weight (Packaged Weight): 6,5kg | Can be connected up to 10 in 1.

REFERENCES

45 MOBBR45ORGBWNW

MOBBR045BXNW

COOLER

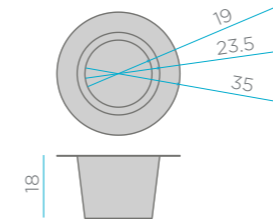

Dimensions (cm)

OPTIONS

Bambú cooler | Indoor & outdoor use

Palma cooler | Indoor & outdoor use

Packaging: 20,6x 20,6 x 22,3 cm | Gross Weight (Packaged Weight): 1kg | Made of aluminium.

REFERENCES

LUMCLB035XXNLNW

LUMCLP035XXNLNW

CRETA 120

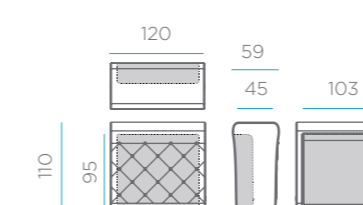

Dimensions (cm)

OPTIONS

Solar & Rechargeable Battery | Indoor & outdoor use IP65 Dimmable Motion sensor

Cable | Indoor & outdoor use IP65

Shelf accessory 21 x 101 x 1cm

Packaging: 120 x 66 x 111,5 cm | Gross Weight (Packaged Weight): 27kg | Methacrylate cover included.

REFERENCES

45 MOBCR120SSNW

600 MOBCR120OFNW

MOBCRE101BXNLNW

IBIZA 120

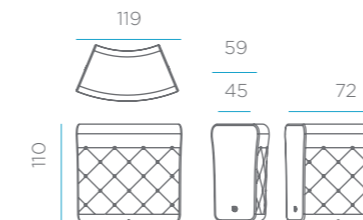

Dimensions (cm)

OPTIONS

Solar & Rechargeable Battery | Indoor & outdoor use IP65 Dimmable Motion sensor

Cable | Indoor & outdoor use IP65

Packaging: 120 x 66 x 111,5 cm | Gross Weight (Packaged Weight): 23,8kg | Methacrylate cover included.

REFERENCES

45 MOBBZ120SSNW

600 MOBBZ120OFNW

PALMA BOTTLE RACK

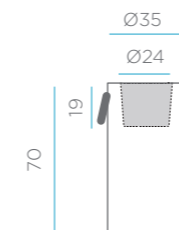

Dimensions (cm)

OPTIONS

Solar & Rechargeable Battery | Indoor & outdoor use IP65 Dimmable Motion sensor

Palma cooler | Indoor & outdoor use

Packaging: 35,5 x 35,5 x 70 cm | Gross Weight (Packaged Weight): 5kg

REFERENCES

45 LUMPMB70SSNW

MP00979

GLOSSARY This technical catalogue is subject to periodic updates, the measurements or finishes may vary in future revisions.

White light (included) Warm light (included) RGB light (included) Warm light portable rechargeable battery (included) LED Led tube lighting (included) Remote control (included) Twilight sensor Motion sensor Dimmable Hanging product Floating, not submersible Integrated speakers Touch control Volume of the plantation area

IP Indicates the level of protection of the electrical or electronic equipment against the entry of external agents: dust or water.

SICILIA 75

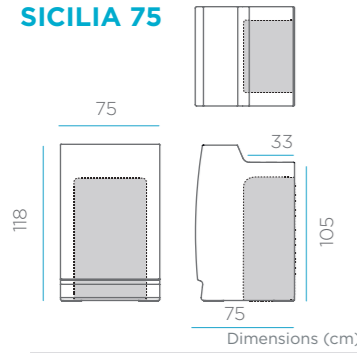

OPTIONS

Solar & Rechargeable Battery | Indoor & outdoor use



LED TUBE

Packaging: 75 x 76,5 x 118,5 cm | Gross Weight (Packaged Weight): 33kg

Im REFERENCES

45 MOBSC075SSNW

SICILIA 120

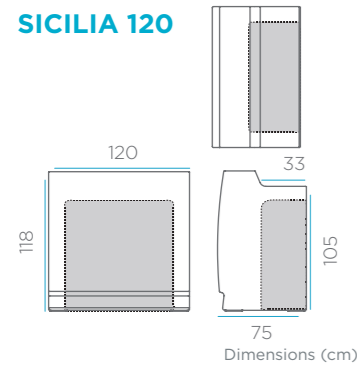

OPTIONS

Solar & Rechargeable Battery | Indoor & outdoor use

Cable | Indoor & outdoor use



LED TUBE

Packaging: 120 x 76,5 x 118,5 cm | Gross Weight (Packaged Weight): 40kg

Im REFERENCES

45 MOBSC120SSNW
2.800 MOBSC120OFNW

White Opaque Colour ○ MOBSC120BXNW

WOODY

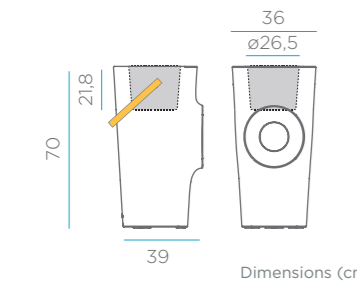

OPTIONS

Solar & Rechargeable Battery | Indoor & outdoor use

Rechargeable Battery | Play: Light & Music | Indoor & outdoor use



LED TUBE

Packaging: 40,5 x 40,5 x 70 cm | Gross Weight (Packaged Weight): 5,2 kg | Vegan leather handle | Cooler accessory included. | Play Light & Music finished x1 Speaker.

Im REFERENCES

45 LUMWD070PLNW
45 LUMWD070SSNW

FLOWERPOTS

In the section of pots you will find pots with double bottoms and pots without double bottoms.

Pots with double bottoms

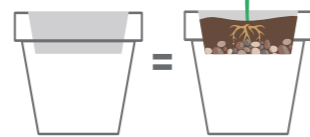

Pots without double bottoms

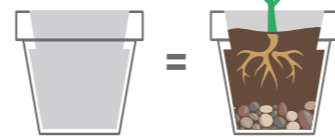

AZALEA 30

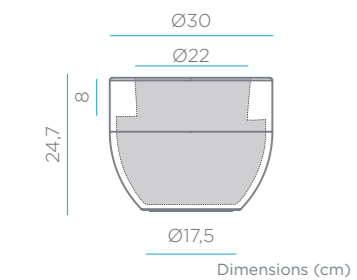

OPTIONS

White Opaque Colour ○ JDNAZA030BXNLNW
Black Opaque Colour ● JDNAZA030NXNLNW
Bronze Opaque Colour ● JDNAZA030ZXNLNW
Terracota Opaque Colour ● JDNAZA030TXNLNW
Anthracite Opaque Colour ● JDNAZA030ANNLNW

Packaging: Plastic bag | Gross Weight (Packaged Weight): 1kg | 9,4L | Product with water reserve.

REFERENCES

AZALEA 40

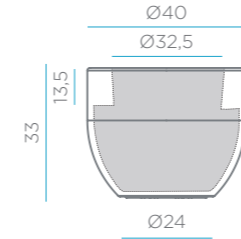

Dimensions (cm)

OPTIONS

White Opaque Colour ○ JDNAZA040BXNLNW
Black Opaque Colour ● JDNAZA040NXNLNW
Bronze Opaque Colour ● JDNAZA040ZXNLNW
Terracota Opaque Colour ● JDNAZA040TXNLNW
Anthracite Opaque Colour ● JDNAZA040ANNLNW

Packaging: Plastic bag | Gross Weight (Packaged Weight): 2kg | 19,7L | Product with water reserve.

REFERENCES

AZALEA 50

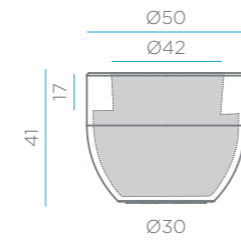

Dimensions (cm)

OPTIONS

White Opaque Colour ○ JDNAZA050BXNLNW
Black Opaque Colour ● JDNAZA050NXNLNW
Bronze Opaque Colour ● JDNAZA050ZXNLNW
Terracota Opaque Colour ● JDNAZA050TXNLNW
Anthracite Opaque Colour ● JDNAZA050ANNLNW

Packaging: Plastic bag | Gross Weight (Packaged Weight): 3,5kg | 37,8L | Product with water reserve.

REFERENCES

BAMBU 70

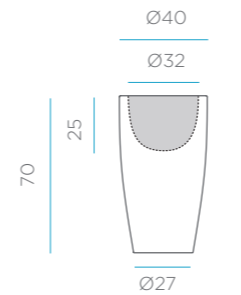

Dimensions (cm)

OPTIONS

WITH LIGHT

Rechargeable Battery | Indoor & outdoor use
 Cable | Indoor & outdoor use



Packaging: 40 x 40 x 70 cm | Gross Weight (Packaged Weight): 4,5kg | 15,8 L | Finished double wall.

Im REFERENCES

315 LUMBM070WLNW
600 LUMBM070OFNW

OPAQUE COLOUR (WITHOUT LIGHT)

White Opaque Colour ○ JDNBM070BXNW
Black Opaque Colour ● JDNBM070NXNW
Bronze Opaque Colour ● JDNBM070ZXNW
Terracota Opaque Colour ● JDNBM070TXNW
Anthracite Opaque Colour ● JDNBM070ANNW

Packaging: 40 x 40 x 70 cm | Gross Weight (Packaged Weight): 4kg | 15,8 L | Finished double wall.

BAMBU 90

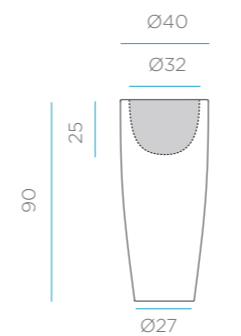

Dimensions (cm)

OPTIONS

WITH LIGHT

Rechargeable Battery | Indoor & outdoor use
 Cable | Indoor & outdoor use



Packaging: 40,5 x 40,5 x 89,5 cm | Gross Weight (Packaged Weight): 6,5kg | 15,8 L | Finished double wall.

Im REFERENCES

335 LUMBM090WLNW
900 LUMBM090OFNW

OPAQUE COLOUR (WITHOUT LIGHT)

White Opaque Colour ○ JDNBM090BXNW
Black Opaque Colour ● JDNBM090NXNW
Bronze Opaque Colour ● JDNBM090ZXNW
Terracota Opaque Colour ● JDNBM090TXNW
Anthracite Opaque Colour ● JDNBM090ANNW

Packaging: 40,5 x 40,5 x 89,5 cm | Gross Weight (Packaged Weight): 6kg | 15,8 L | Finished double wall.

GLOSSARY This technical catalogue is subject to periodic updates, the measurements or finishes may vary in future revisions.

White light (included) Warm light (included) RGB light (included) Remote control (included) Twilight sensor Motion sensor LED Tube Led tube lighting (included)
 Dimmable Hanging product Floating, not submersible Integrated speakers Touch control Volume of the plantation area
IP Indicates the level of protection of the electrical or electronic equipment against the entry of external agents: dust or water.

GLOSSARY This technical catalogue is subject to periodic updates, the measurements or finishes may vary in future revisions.

White light (included) Warm light (included) RGB light (included) Warm light portable rechargeable battery (included) LED Tube Led tube lighting (included) Remote control (included)
 Twilight sensor Motion sensor Dimmable Hanging product Floating, not submersible Integrated speakers Touch control Volume of the plantation area
IP Indicates the level of protection of the electrical or electronic equipment against the entry of external agents: dust or water.

CAMELIA 40

OPTIONS

WITH LIGHT

- Solar & Rechargeable Battery | Indoor & outdoor use
- Cable | Indoor & outdoor use

Packaging: 40,5 x 40,5 x 39,5 cm | Gross Weight (Packaged Weight): 3,2kg | 5,5 L | Finished double wall.

OPAQUE COLOUR (WITHOUT LIGHT)

- White Opaque Colour ○ JDNCA040BXNW
- Black Opaque Colour ● JDNCA040NXNW
- Bronze Opaque Colour ● JDNCA040ZXNW
- Anthracite Opaque Colour ● JDNCA040ANNW

Packaging: Plastic bag | Gross Weight (Packaged Weight): 2,2kg | 5,5 L | Finished double wall.

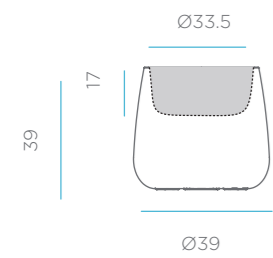

Dimensions (cm)

REFERENCES

- 45 LUMCA040SSNW
- 600 LUMCA040OFNW

CAMELIA LARGE

OPTIONS

WITH LIGHT

- Solar & Rechargeable Battery | Indoor & outdoor use
- Cable | Indoor & outdoor use

Packaging: 50 x 50 x 111 cm | Gross Weight (Packaged Weight): 7,5kg | 43,4 L | Finished double wall.

OPAQUE COLOUR (WITHOUT LIGHT)

- White Opaque Colour ○ JDNCALARBXNW
- Black Opaque Colour ● JDNCALARNXNW
- Bronze Opaque Colour ● JDNCALARZXNW
- Anthracite Opaque Colour ● JDNCALARANNW

Packaging: Plastic bag | Gross Weight (Packaged Weight): 6kg | 43,4 L | Finished double wall.

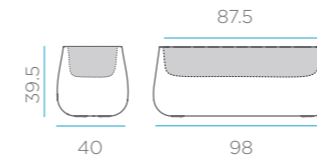

Dimensions (cm)

REFERENCES

- 45 LUMCALARSSNW
- 250 LUMCALAROFNW

CAMELIA 60

OPTIONS

WITH LIGHT

- Solar & Rechargeable Battery | Indoor & outdoor use
- Cable | Indoor & outdoor use

Packaging: 60,5 x 60,5 x 42,7 cm | Gross Weight (Packaged Weight): 5kg | 29,4 L | Finished double wall.

OPAQUE COLOUR (WITHOUT LIGHT)

- White Opaque Colour ○ JDNCA060BXNW
- Black Opaque Colour ● JDNCA060NXNW
- Bronze Opaque Colour ● JDNCA060ZXNW
- Anthracite Opaque Colour ● JDNCA060ANNW

Packaging: Plastic bag | Gross Weight (Packaged Weight): 4,5kg | 29,4 L | Finished double wall.

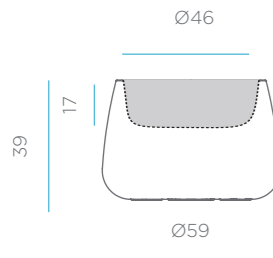

Dimensions (cm)

REFERENCES

- 45 LUMCA060SSNW
- 600 LUMCA060OFNW

FICUS 60

OPTIONS

WITH LIGHT

- Solar & Rechargeable Battery | Indoor & outdoor use
- Cable | Indoor & outdoor use

Packaging: 29,6 x 29,6 x 59,9 | Gross Weight (Packaged Weight): 2,6kg | 9 L

OPAQUE COLOUR (WITHOUT LIGHT)

- White Opaque Colour ○ JDNFC060BXNW
- Black Opaque Colour ● JDNFC060NXNW
- Bronze Opaque Colour ● JDNFC060ZXNW
- Anthracite Opaque Colour ● JDNFC060ANNW

Packaging: Plastic bag | Gross Weight (Packaged Weight): 2,1kg | 16,1 L

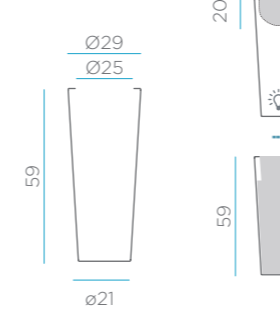

Dimensions (cm)

REFERENCES

- 45 LUMFC060SSNW
- 600 LUMFC060OFNW

CAMELIA 80

OPTIONS

WITH LIGHT

- Solar & Rechargeable Battery | Indoor & outdoor use
- Cable | Indoor & outdoor use

Packaging: Plastic bag | Gross Weight (Packaged Weight): 10,5kg | 74,8 L

OPAQUE COLOUR (WITHOUT LIGHT)

- White Opaque Colour ○ JDNCA080BXNW
- Black Opaque Colour ● JDNCA080NXNW
- Bronze Opaque Colour ● JDNCA080ZXNW
- Anthracite Opaque Colour ● JDNCA080ANNW

Packaging: Plastic bag | Gross Weight (Packaged Weight): 10,5kg | 74,8 L | Finished double wall.

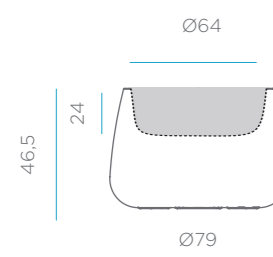

Dimensions (cm)

REFERENCES

- 45 LUMCA080SSNW
- 600 LUMCA080OFNW

FICUS 80

OPTIONS

WITH LIGHT

- Solar & Rechargeable Battery | Indoor & outdoor use
- Cable | Indoor & outdoor use

Packaging: 29,5 x 29,5 x 59,9 | Gross Weight (Packaged Weight): 3,2kg | 9,5 L

OPAQUE COLOUR (WITHOUT LIGHT)

- White Opaque Colour ○ JDNFC080BXNW
- Black Opaque Colour ● JDNFC080NXNW
- Bronze Opaque Colour ● JDNFC080ZXNW
- Anthracite Opaque Colour ● JDNFC080ANNW

Packaging: Plastic bag | Gross Weight (Packaged Weight): 2,7kg | 22,5 L

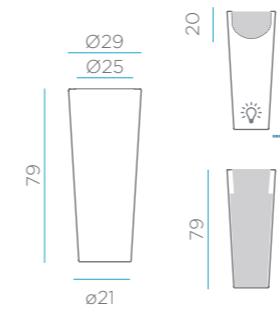

Dimensions (cm)

REFERENCES

- 45 LUMFC080SSNW
- 600 LUMFC080OFNW

CAMELIA HIGH

OPTIONS

WITH LIGHT

- Solar & Rechargeable Battery | Indoor & outdoor use
- Cable | Indoor & outdoor use

Packaging: 40,5 x 40,5 x 69,5 cm | Gross Weight (Packaged Weight): 4kg | 13,9 L | Finished double wall.

OPAQUE COLOUR (WITHOUT LIGHT)

- White Opaque Colour ○ JDNCAHIGBXNW
- Black Opaque Colour ● JDNCAHIGNXNW
- Bronze Opaque Colour ● JDNCAHIGZXNW
- Anthracite Opaque Colour ● JDNCAHIGANNW

Packaging: Plastic bag | Gross Weight (Packaged Weight): 3,5kg | 13,9 L | Finished double wall.

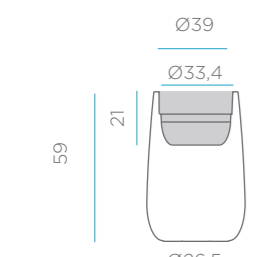

Dimensions (cm)

REFERENCES

- 45 LUMCAHIGSSNW
- 600 LUMCAHIGOFNW

GERBERA 33

OPTIONS

- White Opaque Colour ○
- Black Opaque Colour ●
- Bronze Opaque Colour ●
- Topo Opaque Colour ●
- Terracota Opaque Colour ●
- Anthracite Opaque Colour ●

Packaging: Plastic bag | Gross Weight (Packaged Weight): 1kg | 19,6L | Product with water reserve.

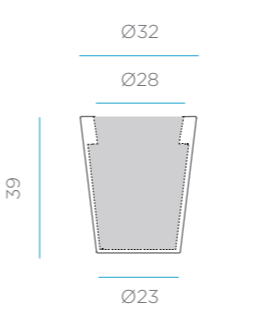

Dimensions (cm)

REFERENCES

- JDNGB033BXNW
- JDNGB033NXNW
- JDNGB033ZXNW
- JDNGB033KXNW
- JDNGB033TXNW
- JDNGB033ANNW

GLOSSARY This technical catalogue is subject to periodic updates, the measurements or finishes may vary in future revisions.

White light (included) Warm light (included) RGB light (included) Warm light portable rechargeable battery (included) Led tube lighting (included) Remote control (included)

Twilight sensor Motion sensor Dimmable Hanging product Floating, not submersible Integrated speakers Touch control Volume of the plantation area

IP Indicates the level of protection of the electrical or electronic equipment against the entry of external agents: dust or water.

GLOSSARY This technical catalogue is subject to periodic updates, the measurements or finishes may vary in future revisions.

White light (included) Warm light (included) RGB light (included) Warm light portable rechargeable battery (included) Led tube lighting (included) Remote control (included)

Twilight sensor Motion sensor Dimmable Hanging product Floating, not submersible Integrated speakers Touch control Volume of the plantation area

IP Indicates the level of protection of the electrical or electronic equipment against the entry of external agents: dust or water.

GERBERA 45

OPTIONS

REFERENCES

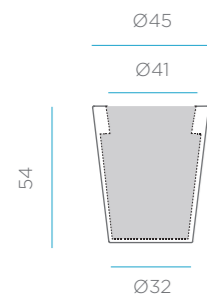

White Opaque Colour ○	JDNGB045BXNW
Black Opaque Colour ●	JDNGB045NXNW
Bronze Opaque Colour ●	JDNGB045ZXNW
Topo Opaque Colour ●	JDNGB045KXNW
Terracota Opaque Colour ●	JDNGB045TXNW
Anthracite Opaque Colour ●	JDNGB045ANNW

Packaging: Plastic bag | Gross Weight (Packaged Weight): 2,2kg | 54,8L | Product with water reserve.

HORTENSIA 40

OPTIONS

REFERENCES

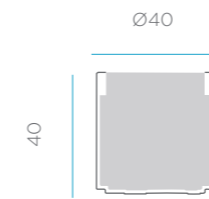

White Opaque Colour ○	JDNHOR040BXNW
Black Opaque Colour ●	JDNHOR040NXNW
Bronze Opaque Colour ●	JDNHOR040ZXNW
Topo Opaque Colour ●	JDNHOR040KXNW
Terracota Opaque Colour ●	JDNHOR040TXNW
Anthracite Opaque Colour ●	JDNHOR040ANNW

Packaging: Plastic bag | Gross Weight (Packaged Weight): 2,5kg | 40L | Product with water reserve.

Dimensions (cm)

GERBERA 50

OPTIONS

REFERENCES

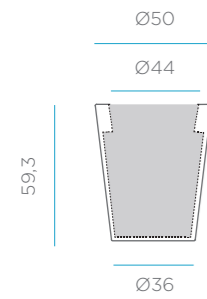

White Opaque Colour ○	JDNGB050BXNW
Black Opaque Colour ●	JDNGB050NXNW
Bronze Opaque Colour ●	JDNGB050ZXNW
Terracota Opaque Colour ●	JDNGB050TXNW
Anthracite Opaque Colour ●	JDNGB050ANNW

RUSTIC TEXTURE

Packaging: Plastic bag | Gross Weight (Packaged Weight): 4kg | 72,8L | Product with water reserve.

Dimensions (cm)

HORTENSIA 50

OPTIONS

REFERENCES

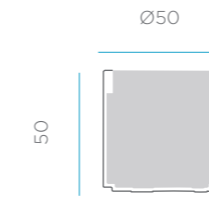

White Opaque Colour ○	JDNHOR050BXNW
Black Opaque Colour ●	JDNHOR050NXNW
Bronze Opaque Colour ●	JDNHOR050ZXNW
Topo Opaque Colour ●	JDNHOR050KXNW
Terracota Opaque Colour ●	JDNHOR050TXNW
Anthracite Opaque Colour ●	JDNHOR050ANNW

Packaging: Plastic bag | Gross Weight (Packaged Weight): 4kg | 81,1L | Product with water reserve.

Dimensions (cm)

LIFT SUPPORT ACCESSORIES

Accessories available only for Hortensia 30

OPTIONS

REFERENCES

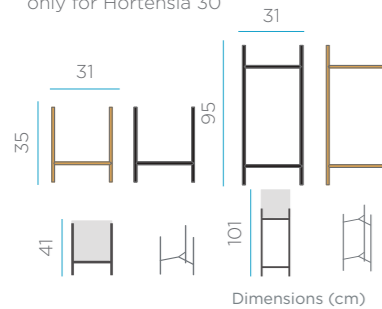

Support accessory 41cm black color ●	JDNLIFT30041NXNW
Support accessory 41cm brass color ●	JDNLIFT30041BRNW
Support accessory 101cm black color ●	JDNLIFT30110NXNW
Support accessory 101cm brass color ●	JDNLIFT30110BRNW

Packaging (Support Accessory 41 cm): 29,2 x 36,9 x 2 cm | Gross Weight (Packaged Weight): 0,6kg
Packaging (Support Accessory 101 cm): 29,2 x 97 x 2 cm | Gross Weight (Packaged Weight): 1,6kg

Dimensions (cm)

HORTENSIA 80

OPTIONS

REFERENCES

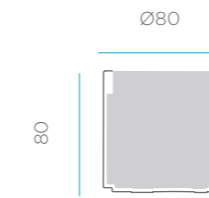

White Opaque Colour ○	JDNHOR080BXNW
Black Opaque Colour ●	JDNHOR080NXNW
Bronze Opaque Colour ●	JDNHOR080ZXNW
Terracota Opaque Colour ●	JDNHOR080TXNW
Anthracite Opaque Colour ●	JDNHOR080ANNW

Packaging: Plastic bag | Gross Weight (Packaged Weight): 12kg | 343 L | Product with water reserve.

Big size

Dimensions (cm)

HORTENSIA 30

OPTIONS

REFERENCES

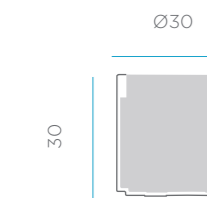

White Opaque Colour ○	JDNHOR030BXNW
Black Opaque Colour ●	JDNHOR030NXNW
Bronze Opaque Colour ●	JDNHOR030ZXNW
Topo Opaque Colour ●	JDNHOR030KXNW
Terracota Opaque Colour ●	JDNHOR030TXNW
Anthracite Opaque Colour ●	JDNHOR030ANNW

Packaging: Plastic bag | Gross Weight (Packaged Weight): 1kg | 17,8L | Product with water reserve.

Dimensions (cm)

JARA 100X35

OPTIONS

REFERENCES

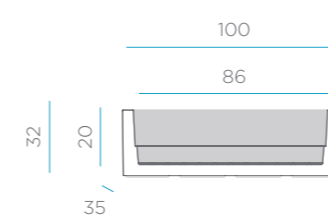

White Opaque Colour ○	JDNJR100BXNW
Black Opaque Colour ●	JDNJR100NXNW
Bronze Opaque Colour ●	JDNJR100ZXNW
Topo Opaque Colour ●	JDNJR100KXNW
Terracota Opaque Colour ●	JDNJR100TXNW
Anthracite Opaque Colour ●	JDNJR100ANNW

Packaging: Plastic bag | Gross Weight (Packaged Weight): 7kg | 51,7L | Finished double wall. Product with water reserve.

Dimensions (cm)

GLOSSARY This technical catalogue is subject to periodic updates, the measurements or finishes may vary in future revisions.

White light (included)
 Warm light (included)
 RGB light (included)
 Warm light portable rechargeable battery (included)
 LED Led tube lighting (included)
 Remote control (included)
 Twilight sensor
 Motion sensor
 Dimmable
 Hanging product
 Floating, not submersible
 Integrated speakers
 Touch control
 Volume of the plantation area

IP Indicates the level of protection of the electrical or electronic equipment against the entry of external agents: dust or water.

GLOSSARY This technical catalogue is subject to periodic updates, the measurements or finishes may vary in future revisions.

White light (included)
 Warm light (included)
 RGB light (included)
 Warm light portable rechargeable battery (included)
 LED Led tube lighting (included)
 Remote control (included)
 Twilight sensor
 Motion sensor
 Dimmable
 Hanging product
 Floating, not submersible
 Integrated speakers
 Touch control
 Volume of the plantation area

IP Indicates the level of protection of the electrical or electronic equipment against the entry of external agents: dust or water.

JARA 100X40

OPTIONS

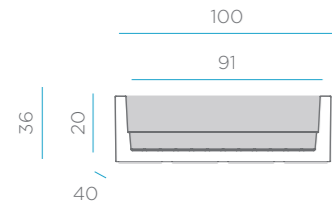

Dimensions (cm)

White Opaque Colour ○	JDNJR140BXNW
Black Opaque Colour ●	JDNJR140NXNW
Bronze Opaque Colour ●	JDNJR140ZXNW
Topo Opaque Colour ●	JDNJR140KXNW
Terracota Opaque Colour ●	JDNJR140TXNW
Anthracite Opaque Colour ●	JDNJR140ANNW

Packaging: Plastic bag | Gross Weight (Packaged Weight): 8kg | 60,7L | Finished double wall. Product with water reserve.

REFERENCES

JUNCO 80

OPTIONS

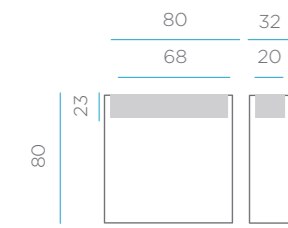

Dimensions (cm)

WITH LIGHT

	Solar & Rechargeable Battery Indoor & outdoor use				45 LUMJN080SSNW
	Cable Indoor & outdoor use				600 LUMJN080OFNW

Packaging: 82 x 34 x 83 | Gross Weight (Packaged Weight): 12kg | 38,8 L | Finished double wall.

OPAQUE COLOUR (WITHOUT LIGHT)

White Opaque Colour ○	JDNJN080BXNW
Black Opaque Colour ●	JDNJN080NXNW
Bronze Opaque Colour ●	JDNJN080ZXNW
Topo Opaque Colour ●	JDNJN080KXNW
Anthracite Opaque Colour ●	JDNJN080ANNW

Packaging: Plastic bag | Gross Weight (Packaged Weight): 10kg | 38,8 L | Finished double wall.

REFERENCES

MAGNOLIA 60

OPTIONS



Dimensions (cm)

WITH LIGHT

	Solar & Rechargeable Battery Indoor & outdoor use				45 LUMMG060SSNW
	Cable Indoor & outdoor use				600 LUMMG060OFNW

Packaging: 59 x 59 x 59 cm | Gross Weight (Packaged Weight): 7kg | 36,7 L | Finished double wall.

OPAQUE COLOUR (WITHOUT LIGHT)

White Opaque Colour ○	JDNMG060BXNW
Black Opaque Colour ●	JDNMG060NXNW
Bronze Opaque Colour ●	JDNMG060ZXNW
Anthracite Opaque Colour ●	JDNMG060ANNW

Packaging: Plastic bag | Gross Weight (Packaged Weight): 5kg | 82,3 L | Product with water reserve.

REFERENCES

MAGNOLIA 30

OPTIONS

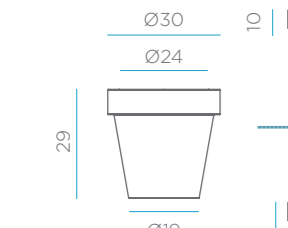

Dimensions (cm)

WITH LIGHT

	Solar & Rechargeable Battery Indoor & outdoor use				45 LUMMG030SSNW
	Cable Indoor & outdoor use				250 LUMMG030OFNW

Packaging: 32,5 x 32,5 x 33 cm | Gross Weight (Packaged Weight): 1,7kg | 3,7 L | Finished double wall.

OPAQUE COLOUR (WITHOUT LIGHT)

White Opaque Colour ○	JDNMG030BXNW
Black Opaque Colour ●	JDNMG030NXNW
Bronze Opaque Colour ●	JDNMG030ZXNW
Anthracite Opaque Colour ●	JDNMG030ANNW

Packaging: Plastic bag | Gross Weight (Packaged Weight): 0,9kg | 7,9 L

REFERENCES

MAGNOLIA 130

OPTIONS



Dimensions (cm)

WITH LIGHT

	Solar & Rechargeable Battery Indoor & outdoor use				600 LUMMG130SSNW
	Cable Indoor & outdoor use				600 LUMMG130OFNW

Packaging: Plastic bag | Gross Weight (Packaged Weight): 36kg | 535 L | Finished double wall.

OPAQUE COLOUR (WITHOUT LIGHT)

White Opaque Colour ○	JDNMG130BXNW
Black Opaque Colour ●	JDNMG130NXNW
Bronze Opaque Colour ●	JDNMG130ZXNW
Anthracite Opaque Colour ●	JDNMG130ANNW

Packaging: Plastic bag | Gross Weight (Packaged Weight): 35kg | 831 L

REFERENCES

MAGNOLIA 45

OPTIONS



Dimensions (cm)

WITH LIGHT

	Solar & Rechargeable Battery Indoor & outdoor use				45 LUMMG045SSNW
	Cable Indoor & outdoor use				600 LUMMG045OFNW

Packaging: 46 x 46 x 46,5 cm | Gross Weight (Packaged Weight): 4 kg | 19,4 L | Finished double wall.

OPAQUE COLOUR (WITHOUT LIGHT)

White Opaque Colour ○	JDNMG045BXNW
Black Opaque Colour ●	JDNMG045NXNW
Bronze Opaque Colour ●	JDNMG045ZXNW
Anthracite Opaque Colour ●	JDNMG045ANNW

Packaging: Plastic bag | Gross Weight (Packaged Weight): 2kg | 33,4 L

REFERENCES

MELISA 30

OPTIONS

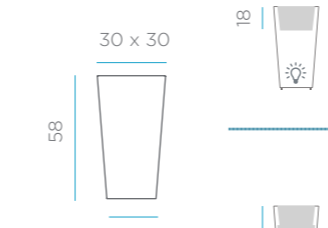

Dimensions (cm)

WITH LIGHT

	Solar & Rechargeable Battery Indoor & outdoor use				45 LUMML030SSNW
	Cable Indoor & outdoor use				600 LUMML030OFNW

Packaging: 31 x 31 x 62,3 cm | Gross Weight (Packaged Weight): 4kg | 6,7 L | Finished double wall.

OPAQUE COLOUR (WITHOUT LIGHT)

White Opaque Colour ○	JDNML030BXNW	Terracota Opaque Colour ●	JDNML030TXNW
Black Opaque Colour ●	JDNML030NXNW	Anthracite Opaque Colour ●	JDNML030ANNW
Bronze Opaque Colour ●	JDNML030ZXNW		
Topo Opaque Colour ●	JDNML030KXNW		

Packaging: Plastic bag | Gross Weight (Packaged Weight): 2,5kg | 11 L

REFERENCES

GLOSSARY This technical catalogue is subject to periodic updates, the measurements or finishes may vary in future revisions.

White light (included) Warm light (included) RGB light (included) Warm light portable rechargeable battery (included) LED Led tube lighting (included) Remote control (included) Twilight sensor Motion sensor Dimmable Hanging product Floating, not submersible Integrated speakers Touch control Volume of the plantation area

IP Indicates the level of protection of the electrical or electronic equipment against the entry of external agents: dust or water.

GLOSSARY This technical catalogue is subject to periodic updates, the measurements or finishes may vary in future revisions.

White light (included) Warm light (included) RGB light (included) Warm light portable rechargeable battery (included) LED Led tube lighting (included) Remote control (included) Twilight sensor Motion sensor Dimmable Hanging product Floating, not submersible Integrated speakers Touch control Volume of the plantation area

IP Indicates the level of protection of the electrical or electronic equipment against the entry of external agents: dust or water.

MELISA 40

OPTIONS

Im REFERENCES

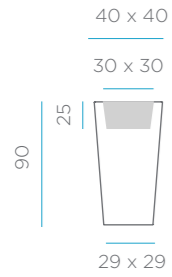

WITH LIGHT

- Solar & Rechargeable Battery | Indoor & outdoor use
- Cable | Indoor & outdoor use



45 LUMML040SSNW
600 LUMML040OFNW

Packaging: 40,5 x 40,5 x 89,5 cm | Gross Weight (Packaged Weight): 7kg | 11,9 L | Finished double wall.

OPAQUE COLOUR (WITHOUT LIGHT)

- White Opaque Colour ○ JDNML040BXNW
- Black Opaque Colour ● JDNML040NXNW
- Bronze Opaque Colour ● JDNML040ZXNW
- Anthracite Opaque Colour ● JDNML040ANNW

Dimensions (cm) | Packaging: Plastic bag | Gross Weight (Packaged Weight): 6kg | 11,9 L | Finished double wall.

MELISA 50

OPTIONS

Im REFERENCES

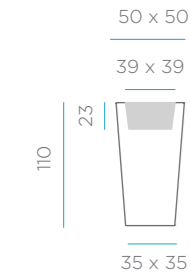

WITH LIGHT

- Solar & Rechargeable Battery | Indoor & outdoor use
- Cable | Indoor & outdoor use



45 LUMML050SSNW
600 LUMML050OFNW

Packaging: 50 x 50 x 111 cm | Gross Weight (Packaged Weight): 11kg | 13,9 L | Finished double wall.

OPAQUE COLOUR (WITHOUT LIGHT)

- White Opaque Colour ○ JDNML050BXNW
- Black Opaque Colour ● JDNML050NXNW
- Bronze Opaque Colour ● JDNML050ZXNW
- Anthracite Opaque Colour ● JDNML050ANNW

Dimensions (cm) | Packaging: Plastic bag | Gross Weight (Packaged Weight): 10kg | 13,9 L | Finished double wall.

NARCISO 35

OPTIONS

REFERENCES

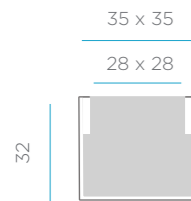

- White Opaque Colour ○ JDNNC035BXNW
- Black Opaque Colour ● JDNNC035NXNW
- Bronze Opaque Colour ● JDNNC035ZXNW
- Terracota Opaque Colour ● JDNNC035TXNW
- Anthracite Opaque Colour ● JDNNC035ANNW

Packaging: Plastic bag | Gross Weight (Packaged Weight): 2kg | 17,4L

Dimensions (cm)

NARCISO 40

OPTIONS

Im REFERENCES

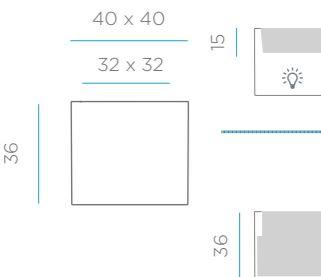

WITH LIGHT

- Solar & Rechargeable Battery | Indoor & outdoor use



45 LUMNC040SSNW

Packaging: 40,5 x 40,5 x 38 cm | Gross Weight (Packaged Weight): 3,5kg | 8,6 L | Finished double wall.

OPAQUE COLOUR (WITHOUT LIGHT)

- White Opaque Colour ○ JDNNC040BXNW
- Black Opaque Colour ● JDNNC040NXNW
- Bronze Opaque Colour ● JDNNC040ZXNW
- Terracota Opaque Colour ● JDNNC040TXNW
- Anthracite Opaque Colour ● JDNNC040ANNW

Dimensions (cm) | Packaging: Plastic bag | Gross Weight (Packaged Weight): 2,5kg | 27,8 L | Product with water reserve.

NARCISO 50

OPTIONS

Im REFERENCES

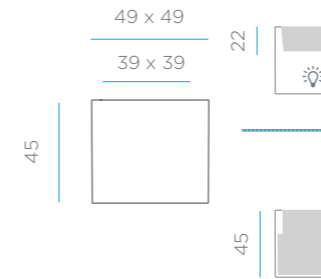

WITH LIGHT

- Solar & Rechargeable Battery | Indoor & outdoor use



45 LUMNC050SSNW

Packaging: 59 x 59 x 59 cm | Gross Weight (Packaged Weight): 6,5kg | 19 L | Finished double wall.

OPAQUE COLOUR (WITHOUT LIGHT)

- White Opaque Colour ○ JDNNC050BXNW
- Black Opaque Colour ● JDNNC050NXNW
- Bronze Opaque Colour ● JDNNC050ZXNW
- Terracota Opaque Colour ● JDNNC050TXNW
- Anthracite Opaque Colour ● JDNNC050ANNW

Dimensions (cm) | Packaging: Plastic bag | Gross Weight (Packaged Weight): 5kg | 53,8 L | Product with water reserve.

NARCISO 60

OPTIONS

REFERENCES

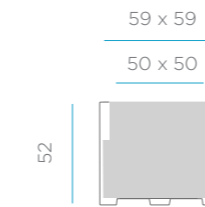

- White Opaque Colour ○ JDNNC060BXNW
- Black Opaque Colour ● JDNNC060NXNW
- Bronze Opaque Colour ● JDNNC060ZXNW
- Anthracite Opaque Colour ● JDNNC060ANNW

Packaging: Plastic bag | Gross Weight (Packaged Weight): 7kg | 84,8L

Dimensions (cm)

OLIVO 50

OPTIONS

REFERENCES

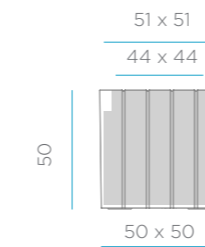

- White Opaque Colour ○ JDNOLI050BXNLNW
- Black Opaque Colour ● JDNOLI050NXNLNW
- Bronze Opaque Colour ● JDNOLI050ZXNLNW
- Terracota Opaque Colour ● JDNOLI050TXNLNW
- Anthracite Opaque Colour ● JDNOLI050ANNLNW

Packaging: Plastic bag | Gross Weight (Packaged Weight): 4,5kg | 105L | Product with water reserve.

Dimensions (cm)

OLIVO HIGH

OPTIONS

REFERENCES

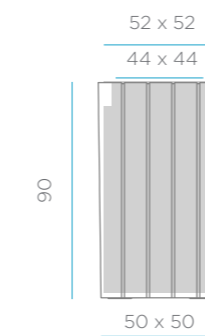

- White Opaque Colour ○ JDNOLI090BXNLNW
- Black Opaque Colour ● JDNOLI090NXNLNW
- Bronze Opaque Colour ● JDNOLI090ZXNLNW
- Terracota Opaque Colour ● JDNOLI090TXNLNW
- Anthracite Opaque Colour ● JDNOLI090ANNLNW

Packaging: Plastic bag | Gross Weight (Packaged Weight): 8kg | 205L | Product with water reserve.

Dimensions (cm)

GLOSSARY This technical catalogue is subject to periodic updates, the measurements or finishes may vary in future revisions.

White light (included) Warm light (included) RGB light (included) Warm light portable rechargeable battery (included) Led tube lighting (included) Remote control (included)
 Twilight sensor Motion sensor Dimmable Hanging product Floating, not submersible Integrated speakers Touch control Volume of the plantation area

IP Indicates the level of protection of the electrical or electronic equipment against the entry of external agents: dust or water.

GLOSSARY This technical catalogue is subject to periodic updates, the measurements or finishes may vary in future revisions.

White light (included) Warm light (included) RGB light (included) Warm light portable rechargeable battery (included) Led tube lighting (included) Remote control (included)
 Twilight sensor Motion sensor Dimmable Hanging product Floating, not submersible Integrated speakers Touch control Volume of the plantation area

IP Indicates the level of protection of the electrical or electronic equipment against the entry of external agents: dust or water.

OLIVO LARGE

OPTIONS

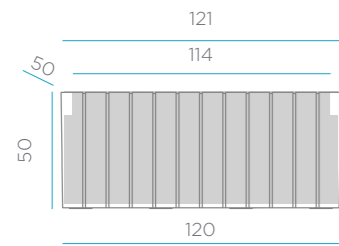

Dimensions (cm)

- | | |
|----------------------------|-----------------|
| White Opaque Colour ○ | JDNOLI120BXNLNW |
| Black Opaque Colour ● | JDNOLI120NXNLNW |
| Bronze Opaque Colour ● | JDNOLI120ZXNLNW |
| Terracota Opaque Colour ● | JDNOLI120TXNLNW |
| Anthracite Opaque Colour ● | JDNOLI120ANNLNW |

Packaging: Plastic bag | Gross Weight (Packaged Weight): 7kg | 252 L | Product with water reserve.

REFERENCES

PALMA 70

OPTIONS

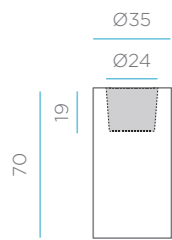

Dimensions (cm)

WITH LIGHT

- Solar & Rechargeable Battery | Indoor & outdoor use
- Cable | Indoor & outdoor use

Packaging: 35,5 x 35,5 x 70 cm | Gross Weight (Packaged Weight): 4,5kg | 9,1 L | Finished double wall.

REFERENCES

- 45 LUMPM070SSNW
- 600 LUMPM070OFNW

PALMERA

OPTIONS

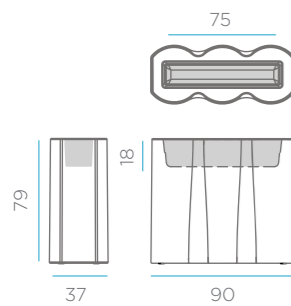

Dimensions (cm)

WITH LIGHT

- Solar & Rechargeable Battery | Indoor & outdoor use

Packaging: Plastic bag | Gross Weight (Packaged Weight): 10,5kg | 20 L | Finished double wall.

OPAQUE COLOUR (WITHOUT LIGHT)

- White Opaque Colour ○ — JDNPA080BXNW

Packaging: Plastic bag | Gross Weight (Packaged Weight): 10kg | 20 L | Finished double wall.

VIOLETA 30

OPTIONS

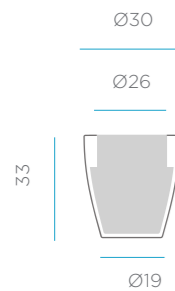

Dimensions (cm)

- | | |
|----------------------------|--------------|
| White Opaque Colour ○ | JDNVL030BXNW |
| Black Opaque Colour ● | JDNVL030NXNW |
| Bronze Opaque Colour ● | JDNVL030ZXNW |
| Topo Opaque Colour ● | JDNVL030KXNW |
| Terracota Opaque Colour ● | JDNVL030TXNW |
| Anthracite Opaque Colour ● | JDNVL030ANNW |

Packaging: Plastic bag | Gross Weight (Packaged Weight): 1kg | 12,5 L | Product with water reserve.

REFERENCES

VIOLETA 40

OPTIONS

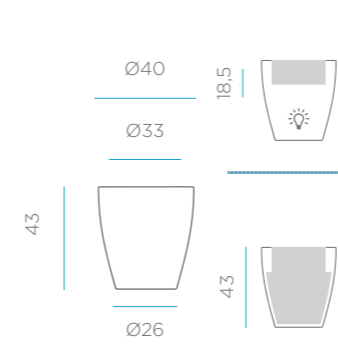

Dimensions (cm)

WITH LIGHT

- Solar & Rechargeable Battery | Indoor & outdoor use

Packaging: 46 x 46 x 46,5 cm | Gross Weight (Packaged Weight): 3kg | 14,5 L | Finished double wall.

OPAQUE COLOUR (WITHOUT LIGHT)

- | | | | |
|------------------------|--------------|----------------------------|--------------|
| White Opaque Colour ○ | JDNVL040BXNW | Terracota Opaque Colour ● | JDNVL040TXNW |
| Black Opaque Colour ● | JDNVL040NXNW | Anthracite Opaque Colour ● | JDNVL040ANNW |
| Bronze Opaque Colour ● | JDNVL040ZXNW | | |
| Topo Opaque Colour ● | JDNVL040KXNW | | |

Packaging: Plastic bag | Gross Weight (Packaged Weight): 2,5kg | 30,6 L | Product with water reserve.

REFERENCES

- 45 LUMVL040SSNW

VIOLETA 55

OPTIONS

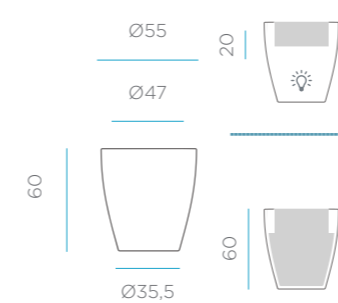

Dimensions (cm)

WITH LIGHT

- Solar & Rechargeable Battery | Indoor & outdoor use

Packaging: 59 x 59 x 59 cm | Gross Weight (Packaged Weight): 5,5kg | 34,7 L | Finished double wall.

OPAQUE COLOUR (WITHOUT LIGHT)

- | | | | |
|------------------------|--------------|----------------------------|--------------|
| White Opaque Colour ○ | JDNVL055BXNW | Terracota Opaque Colour ● | JDNVL055TXNW |
| Black Opaque Colour ● | JDNVL055NXNW | Anthracite Opaque Colour ● | JDNVL055ANNW |
| Bronze Opaque Colour ● | JDNVL055ZXNW | | |

Packaging: Plastic bag | Gross Weight (Packaged Weight): 5kg | 68,2 L | Product with water reserve.

REFERENCES

- 45 LUMVL055SSNW

GLOSSARY This technical catalogue is subject to periodic updates, the measurements or finishes may vary in future revisions.

- ☀ White light (included)
- 🔥 Warm light (included)
- 🌈 RGB light (included)
- 🔋 Warm light portable rechargeable battery (included)
- 💡 LED Led tube lighting (included)
- 📶 Remote control (included)
- 🌙 Twilight sensor
- 👁 Motion sensor
- 📊 Dimmable
- 🌀 Hanging product
- 🌊 Floating, not submersible
- 🔊 Integrated speakers
- 👉 Touch control
- 💧 Volume of the plantation area

IP Indicates the level of protection of the electrical or electronic equipment against the entry of external agents: dust or water.

GLOSSARY This technical catalogue is subject to periodic updates, the measurements or finishes may vary in future revisions.

- ☀ White light (included)
- 🔥 Warm light (included)
- 🌈 RGB light (included)
- 🔋 Warm light portable rechargeable battery (included)
- 💡 LED Led tube lighting (included)
- 📶 Remote control (included)
- 🌙 Twilight sensor
- 👁 Motion sensor
- 📊 Dimmable
- 🌀 Hanging product
- 🌊 Floating, not submersible
- 🔊 Integrated speakers
- 👉 Touch control
- 💧 Volume of the plantation area

IP Indicates the level of protection of the electrical or electronic equipment against the entry of external agents: dust or water.



The possible differences between the original color, illumination and color captured are due to the printing technique.

NEWGARDEN reserves the right over photographs and designs made, so it is forbidden the manufacture, distribution and / or marketing of the products shown on any medium or support.

NEWGARDEN reserves the right to modify, in whole or in part, without prior notice, any information or technical specification of this publication.

All the information that appears in this catalog in terms of dimensions and capacity are approximate and are susceptible to variations due to improvements in the production process.

#BeHappy

@ Copyright. 2021. Newgarden Spain.
Todos los derechos reservados

**Avenida de Francia, 5-15 30840
Alhama de Murcia. Murcia (Spain)**

**info@newgarden.es
T. +34 968978806**