



NEWGARDEN



Light & Deco.

FLOOR LAMPS	OKINAWA 170	19	PORTABLE HANGING LAMPS	GARLAND LIFT	105	
	SANTORINI	21		EDY	107	
	NIZA 165	23		CONTA MINI	108	
	NIZA 230	25		NEO	109	
	AMALFI 145	27		ELBA	111	
	LOLA SLIM 120 / 180	29		MYKONOS	113	
	CHLOE PLANT	31		CONTA	114	
	CHLOE 140	33		POSITANO	115	
	ROCKET 70	35		OKINAWA	117	
	ROCKET 145	35		BOSSA	118	
	FITY 100	37		SISINE	119	
	FITY 160	37		CALOBRA	120	
	PANCHO	39		REONA	121	
	LOLA 110 / 165 / 200	41		BENIRRÁS	122	
	CARMEN 110/165	45		SAONA	123	
	FREDO 110 / 170	47		PIANETA 25/ 35 /45	125	
	KONIKA	49		BITA	127	
	GRACE 140 / 170	51		SORA	127	
	KAKTUS	53		NORAI	127	
	TABLE LAMPS & DECORATIVE	OKINAWA LANTERN		55	KURBY	129
		SIROCO 30/50		57	NÓMADA	130
		HIAMA		59	CUBY 45 PLAY	131
		GRETITA TABLE		65	CHERRY	133
		GRETITA TABLE SOLAR		65	SOLAR CHERRY	133
		CONTA 30/70		67	CHERRY MINI	135
		SAONA 30/70		69	COCO	137
		SISINE 30/70		71	BANANA	138
		BOSSA 30		72	LIMA	139
		OKINAWA TABLE LAMP		73	GRETITA	61
		CHLOE 35		74	GRETA	63
		JACK LUX		75	ROLL 8	140
		LOLA 12 LUX		76	ROLL 4	141
		LOLA 20 LUX		77	ROLL ACCESSORY	142
		SHITAKE		78	BOX 8	143
		MAIA		79	PEPITA	145
		SARDINIA 30/40		81	PAQUITA	147
		CANDY		83	SUNSET	149
		NORAI SLIM 35		85	WALLY SQUARE	151
		LOLA SLIM 30		87	WALLY DISK	153
		ROCKET 20		88	BOSSA WALL	154
		PANCHITO		89	SISINE WALL	155
LOLA 20 / 30 / 45		91	SAONA WALL	156		
ALLEGRA		93	CONTA WALL	157		
STELLA		94	BULY	159		
MYKONOS		95	PETRA	163		
AURORA		96	CUBY	165		
ALBA		97	PAPAYA 12	168		
HIAMA		98	PAPAYA 30	169		
OKINAWA		99	BULY FLOATING	170		
BRUNA		100	PLAY DISK 40	171		
CHELSEA		102	INDOOR & CHRISTMAS	175		
LUCEO		103				

Furniture.

RASA	183
FORMENTERA	185
NEW ISLAND	189
TARIDA	191
TAFY & CUBY	194
TAFY & PUFY	195
CAPRI 40 & CORFU 40	197
CAPRI 75 & MALLORCA	199
CAPRI 110 & CORFU 74	201
ITACA & MALLORCA	203
BORA	205
SICILIA 75 / 120	207
IBIZA 120	209
CRETA 120	211
PALMA BOTTLE	212
WOODY	213

Flowerpots.

AZALEA	217
HORTENSIA	219
MAGNOLIA	222
MELISA	228
PALMA 70	231
FICUS	233
BAMBÚ	235
JARA	236
JUNCO	237
NARCISO	239
GERBERA	240
CAMELIA	241
JAZMÍN	248
CLAVEL	249
VIOLETA	251
GIRASOL	252
CALÉNDULA	253
CAMOMILA	254
PETUNIA	255
ROSA	257
PLATES	259

Circoolar by Newgarden.

CIRCOOLAR By Newgarden	10
RASA	183
TARIDA SET	191
CUBY 53	194
TAFY	195
HORTENSIA	219
CAMELIA	242



By Newgarden

Crafting
your
indoor and
outdoor
moments.



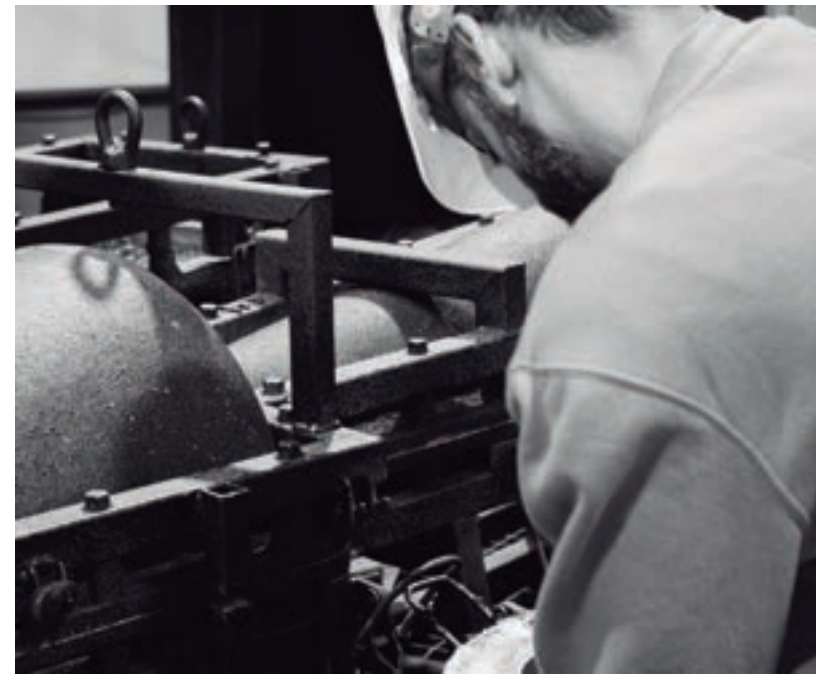
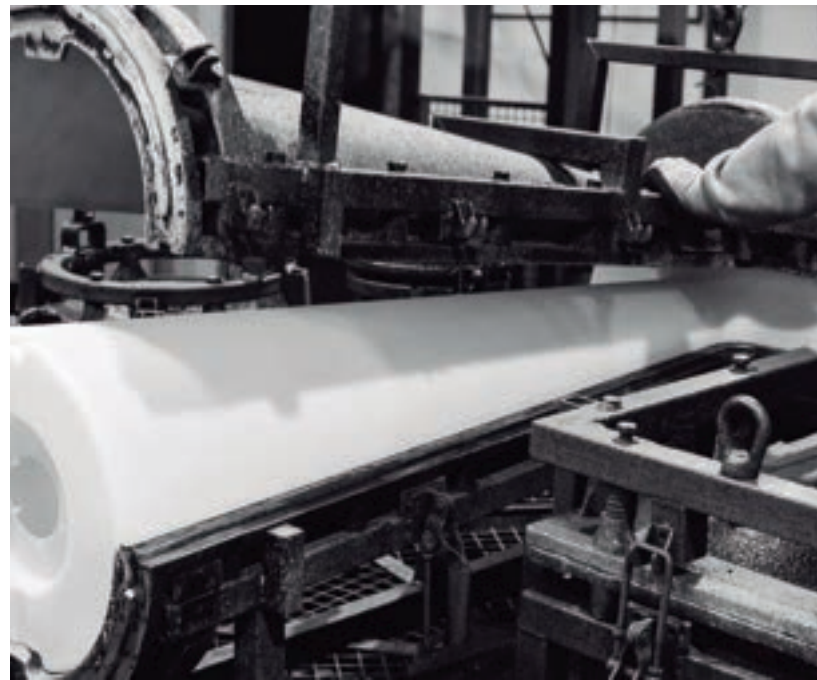
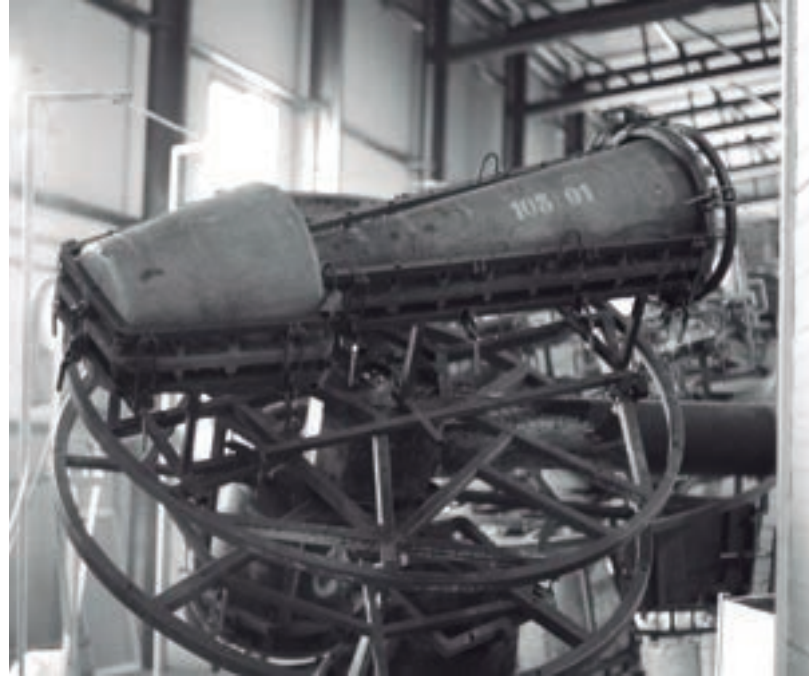

European
manufacturers
and designers
of moments.

A different way of embracing sustainability.

WE HAVE OUR OWN VISION OF SUSTAINABILITY, INTRODUCING CIRCOOLAR BY
NEWGARDEN.

SUSTAINABILITY IS MUCH MORE THAN RECYCLING. IT IS MUCH MORE THAN
USING LED LIGHTS. IT IS MUCH MORE THAN BEING MANUFACTURERS.

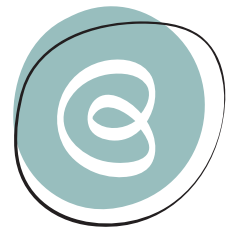

CIRCOOLAR
By Newgarden

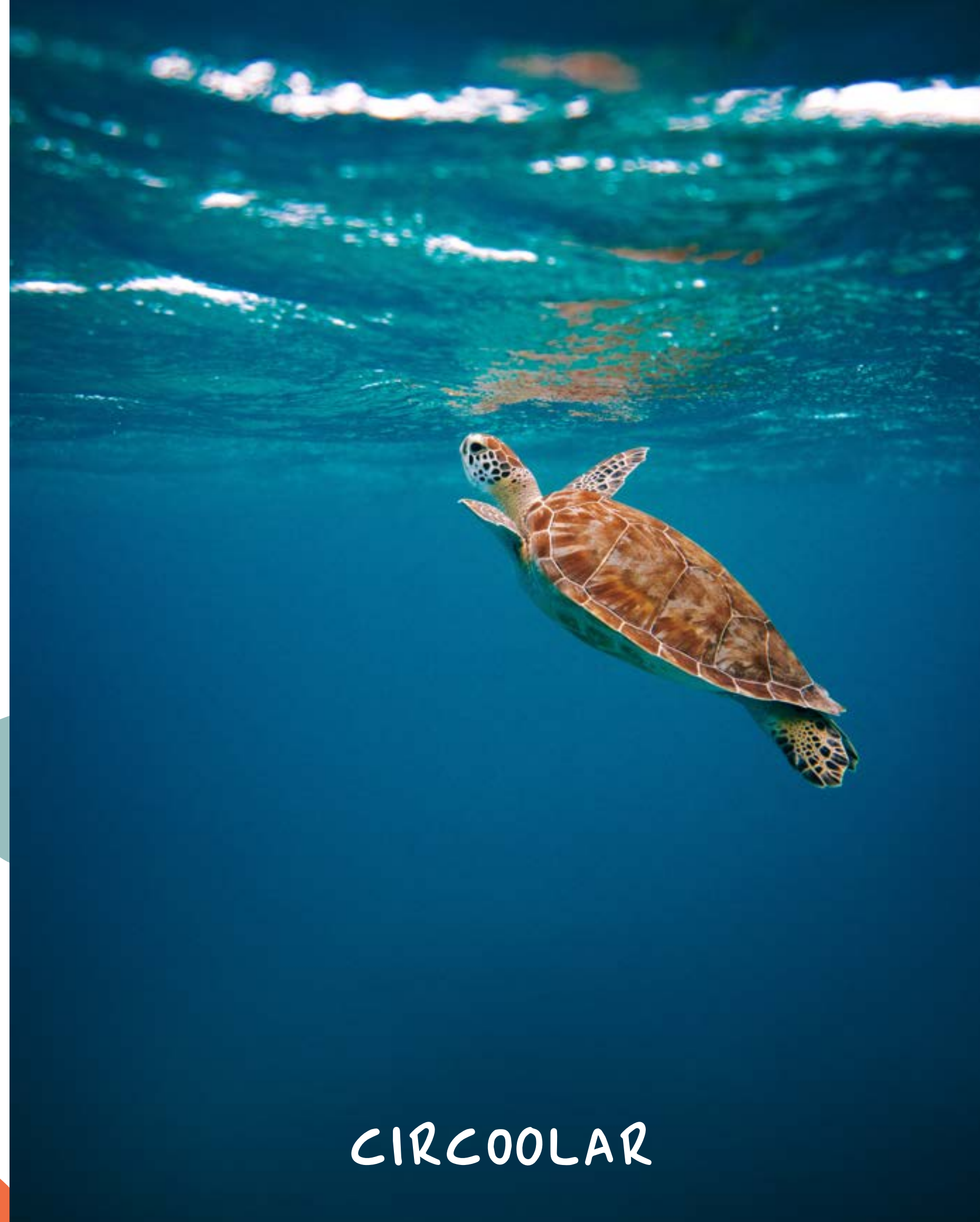

CIRCOOLAR



Another sustainability can be is possible

CIRCOOLAR 
By Newgarden



MADE FROM FISHING NETS RETRIEVED FROM THE MEDITERRANEAN SEA



RESPONSIBLY MADE FURNITURE AND LIGHTING

PROUD TO BE SPANISH MANUFACTURERS



PRODUCTS | CIRCOOLAR

(1) TARIDA SET | PAG 191
(4) RASA | PAG 182

(2) TAFY & CUBY 53 | PAG 194
(5) CAMELIA | PAG 241

(3) HORTENSIA | PAG 218

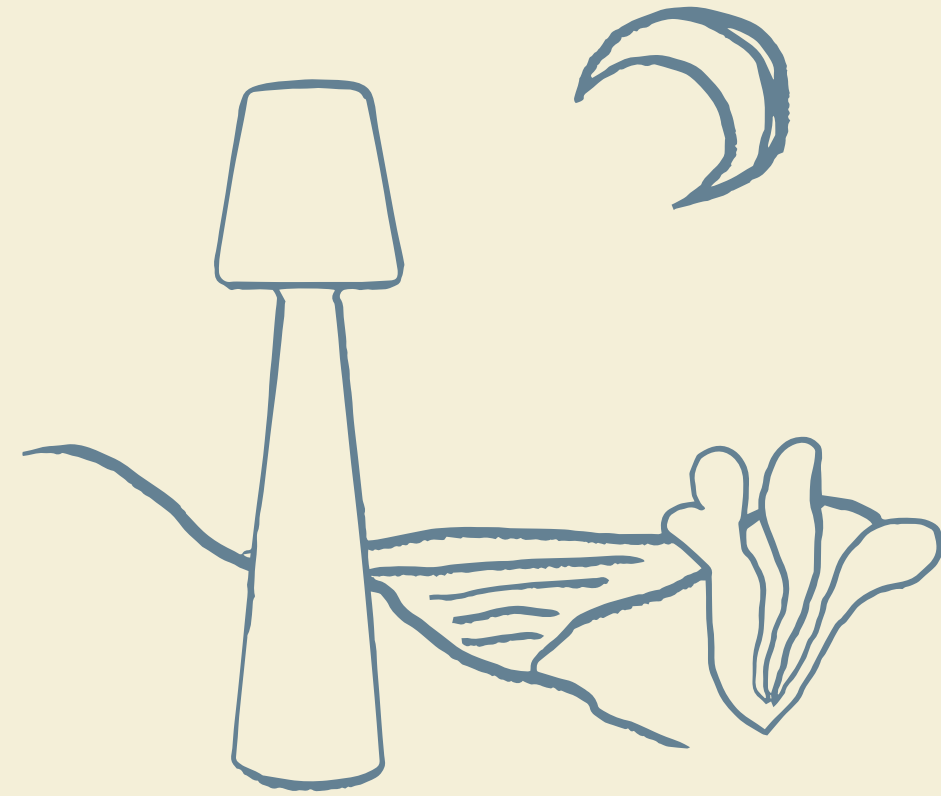

Light & Deco

Candlelight DINNER

PRODUCTS

(1) BOSSA
(5) SAONA 70

(2) EDY G125
(6) SISINE

(3) AURORA
(7) POSITANO

(4) MALLORCA
(8) HIAMA

(9) CAPRI



1

2

3

7

6

5

4

9

8

Okinawa.



OKINAWA 170 | NATURE COLLECTION

SOLAR & RECHARGEABLE BATTERY

REF: LUMOKI170XXSWNW

- IP54 Outdoor & Indoor use
- Solar + Rechargeable Battery (driver not included)
- Warm Light (included)
- 900 lm
- Remote control (included)

- Dimmable
- Rechargeable bulb Cherry (included)
- Bamboo
- Packaging: 50 x 47 x 47 cm
- Gross Weight (with packaging): 8,5kg

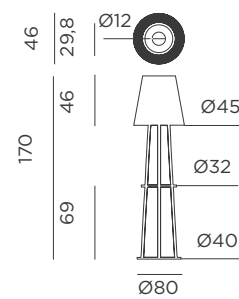

Dimensions (cm)

Santorini.
Santorini.
Santorini.
Santorini.



SANTORINI | NATURE COLLECTION

RECHARGEABLE BATTERY

- IP54 Outdoor & Indoor use
- 🔋 Rechargeable Battery Electric Charge (driver not included)
- 💡 Warm Light (included)
- lm 900 lm
- 📡 Remote control (included)

REF: LUMSTN165BXWLNW

- 🔊 Dimmable
- 💡 Rechargeable bulb Cherry (included)
- 🪵 Rattan & Lacquered Steel (white colour)
- 📦 Packaging: 34,9 x 45 x 37 cm
- 📦 Gross Weight (with packaging): 6.7kg

Floor lamp & wall lamp
2 lamps in 1

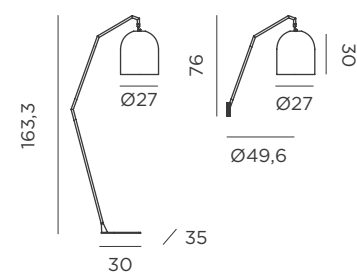

Dimensions (cm)

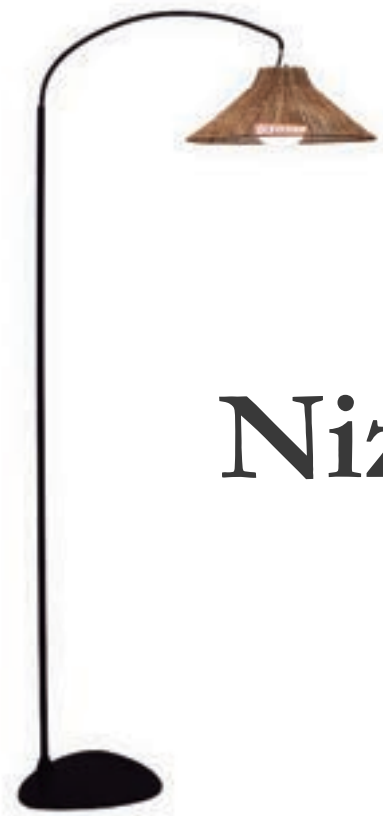

Niza 165.

NIZA 165 | NATURE COLLECTION

RECHARGEABLE BATTERY

REF: LUMNIZ165NXWLNW

- IP54 Outdoor & Indoor use
- Rechargeable Battery Electric Charge (driver not included)
- Warm Light (included)
- 900 lm
- Remote control (included)

- Dimmable
- Rechargeable bulb Cherry (included)
- Seagrass | Lacquered Iron (black colour)
- Packaging: 28 x 43,9 x 47,5 cm
- Gross Weight (with packaging): 6,7kg

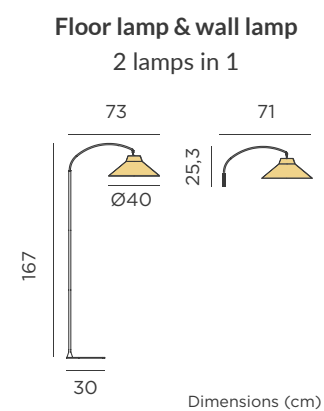



Niza 230.

NIZA 230 | NATURE COLLECTION

RECHARGEABLE BATTERY

- IP54 Outdoor & Indoor use
- Rechargeable Battery Electric Charge (driver not included)
- Warm Light (included)
- 900 lm
- Remote control (included)

REF: LUMNIZ230BXWLNW

- Dimmable
- Rechargeable bulb Cherry (included)
- Seagrass | Lacquered Iron (black colour)
- Packaging: 82,5 x 92,5 x 46,5 cm
- Gross Weight (with packaging): 19,3kg

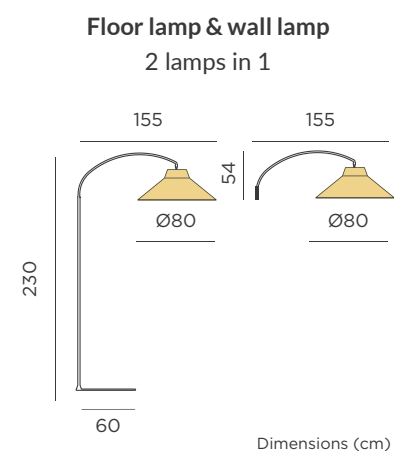



Amalfi.



AMALFI | NATURE COLLECTION

🔋 RECHARGEABLE BATTERY

- IP54 Outdoor & Indoor use
- 🔌 Rechargeable Battery Electric Charge (driver not included)
- 💡 Warm Light (included)
- lm 900 lm
- 📶 Remote control (included)

REF: LUMAMA145BXWLNW



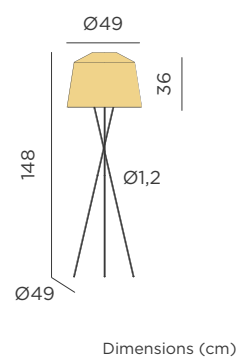





- 📶 Dimmable
- 🔌 Rechargeable bulb Cherry (included)
- M Rattan | Lacquered Iron (black colour)
- 📦 Packaging: 63,8 x 52 x 57 cm
- 📦 Gross Weight (with packaging): 8,36kg







Lola Slim 120.

LOLA SLIM 120

SOLAR & RECHARGEABLE BATTERY

- IP65 Outdoor & Indoor use
-  Solar + Rechargeable Battery (driver not included)
-  Warm Light (included)
-  White Light (included)
-  RGB Light (included)
- lm 600 lm
-  Remote control (included)
-  Dimmable
-  Twilight sensor
- M** Lacquered Iron | Polyethylene
-  Packaging: 39 x 39 x 39,5 cm
-  Gross Weight (with packaging): 7kg



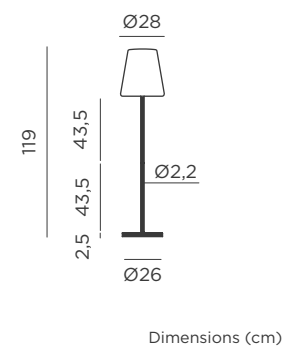





- Rose gold |  **REF: LUMLLS120RGSSNW**
- Brass |  **REF: LUMLLS120BRSSNW**
- Space grey |  **REF: LUMLLS120GESSNW**
- Anthracite |  **REF: LUMLLS120ANSSNW**



Lola Slim 180.

LOLA SLIM 180

SOLAR & RECHARGEABLE BATTERY

- IP65 Outdoor & Indoor use
-  Solar + Rechargeable Battery (driver not included)
-  Warm Light (included)
-  White Light (included)
-  RGB Light (included)
- lm 800 lm
-  Remote control (included)
-  Dimmable
-  Twilight sensor
- M** Lacquered Iron | Polyethylene
-  Packaging: 47 x 54 x 58,5 cm
-  Gross Weight (with packaging): 19,64kg

- Rose gold |  **REF: LUMLLS180RGSSNW**
- Brass |  **REF: LUMLLS180BRSSNW**

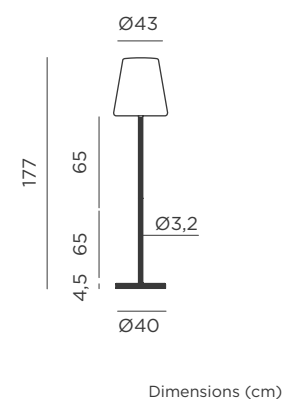

JUTE CABLE

- IP65 Outdoor & Indoor use
-  Warm Light (included)
-  White Light (included)
- lm 860 lm
-  Remote control (included)
-  Dimmable
- M** Lacquered Iron | Polyethylene
-  Packaging: 47 x 54 x 58,5 cm
-  Gross Weight (with packaging): 19,64kg

- Rose gold |  **REF: LUMLLS180RGINOUTNW**
- Brass |  **REF: LUMLLS180BRINOUTNW**

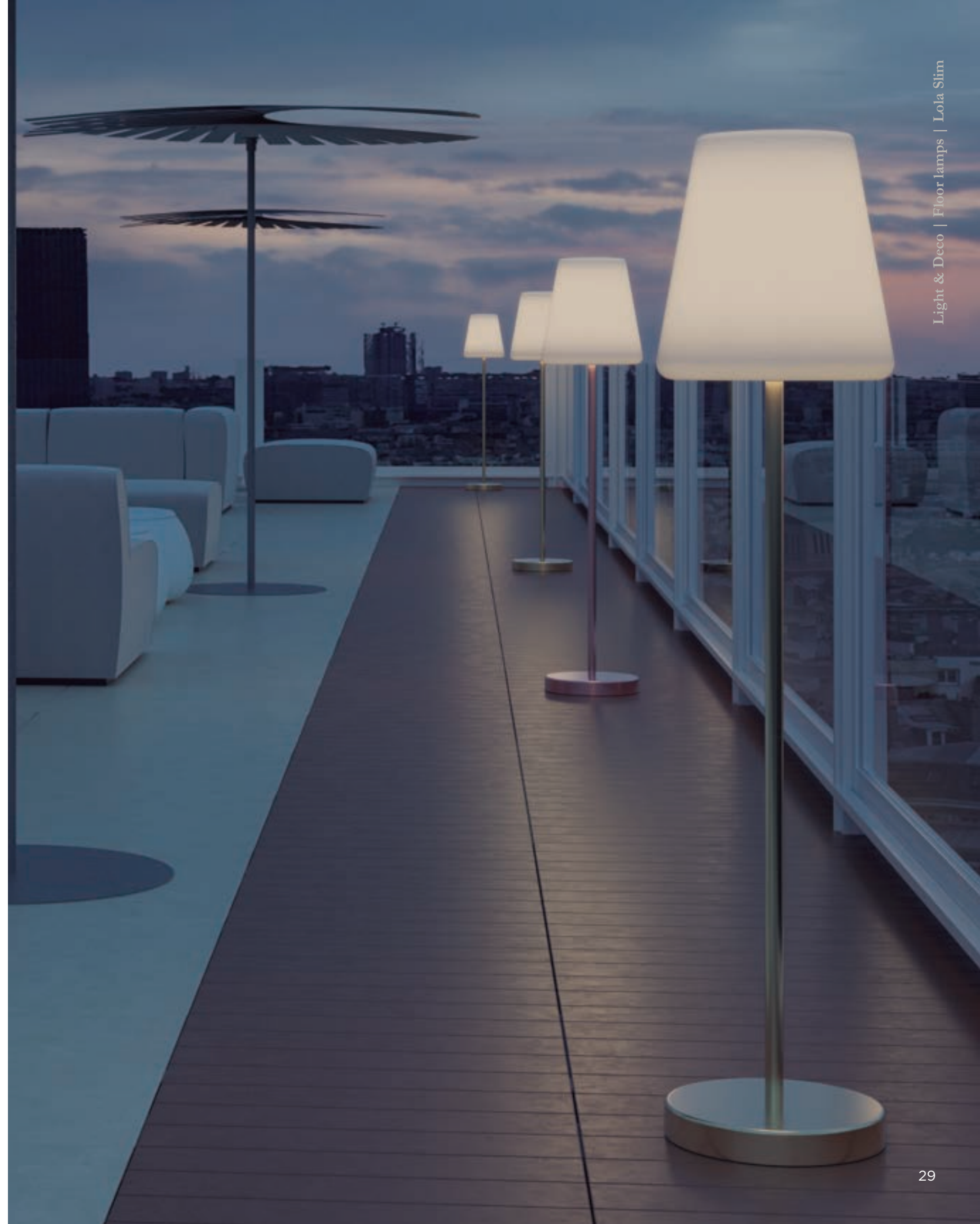

Chloe Plant.



CHLOE PLANT

SOLAR & RECHARGEABLE BATTERY

REF: LUMCHLPLTSSNW

- IP65 Outdoor & Indoor use
- Rechargeable Battery Electric Charge (driver not included)
- Warm Light (included)
- White Light (included)
- RGB Light (included)
- 600 lm

- Remote control (included)
- Dimmable
- Twilight sensor
- Lacquered Iron (wood colour) | Polyethylene
- Packaging: 46 x 46 x 39 cm
- Gross Weight (with packaging): 13,5kg

5 lamps in 1

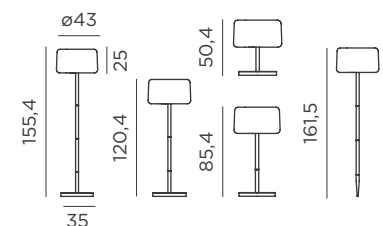

Dimensions (cm)



Chloe 140.

CHLOE 140

SOLAR & RECHARGEABLE BATTERY

REF: LUMCHL140SSNW

- IP65 Outdoor & Indoor use
- Solar + Rechargeable Battery (driver not included)
- Warm Light (included)
- White Light (included)
- RGB Light (included)
- 600 lm

- Remote control (included)
- Dimmable
- Twilight sensor
- Beechwood | Polyethylene
- Packaging: 31,6 x 46 x 123 cm
- Gross Weight (with packaging): 5,2kg

JUTE CABLE

REF: LUMCHL140INOUTNW

- IP65 Outdoor & Indoor use
- Warm Light (included)
- White Light (included)
- 860 lm
- Remote control (included)

- Dimmable
- Beechwood | Polyethylene
- Packaging: 31,6 x 46 x 123 cm
- Gross Weight (with packaging): 5,2kg

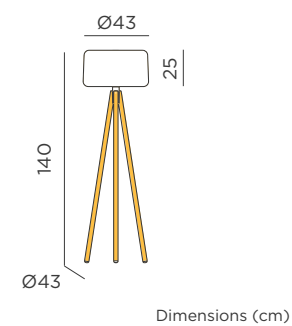













Rocket 70.

ROCKET 70

SOLAR & RECHARGEABLE BATTERY

REF: LUMRCK70SSNW



-  Outdoor & Indoor use
-  Solar + Rechargeable Battery (driver nor included)
-  Warm Light (included)
-  White Light (included)
-  RGB Light (included)
-  600 lm

-  Remote control (included)
-  Dimmable
-  Twilight sensor
-  Beechwood | Polyethylene
-  Packaging: 37,5 x 37,5 x 43 cm
-  Gross Weight (with packaging): 3kg

JUTE CABLE

REF: LUMRCK070INOUTNW

-  Outdoor & Indoor use
-  Warm Light (included)
-  White Light (included)
-  860 lm
-  Remote control (included)

-  Dimmable
-  Beechwood | Polyethylene
-  Packaging: 37,5 x 37,5 x 43 cm
-  Gross Weight (with packaging): 3kg

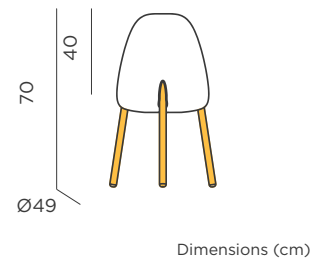

ROCKET 70

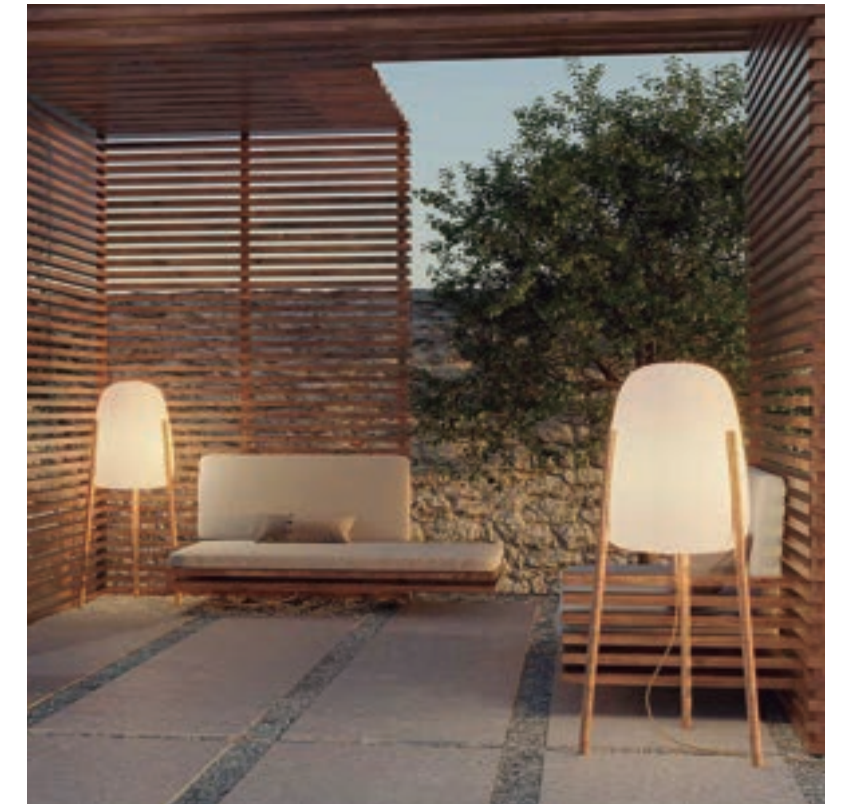







ROCKET 145







Rocket 145.

ROCKET 145

SOLAR & RECHARGEABLE BATTERY

REF: LUMRCK145SSNW





-  Outdoor & Indoor use
-  Solar + Rechargeable Battery (driver nor included)
-  Warm Light (included)
-  White Light (included)
-  RGB Light (included)
-  600 lm

-  Remote Control (included)
-  Dimmable
-  Twilight sensor
-  Beechwood | Polyethylene
-  Packaging: 51 x 50,5 x 120,5 cm
-  Gross Weight (with packaging): 8kg

JUTE CABLE

REF: LUMRCK145INOUTNW

-  Outdoor & Indoor use
-  Warm Light (included)
-  White Light (included)
-  860 lm
-  Remote control (included)

-  Dimmable
-  Beechwood | Polyethylene
-  Packaging: 51 x 50,5 x 120,5 cm
-  Gross Weight (with packaging): 8,2kg

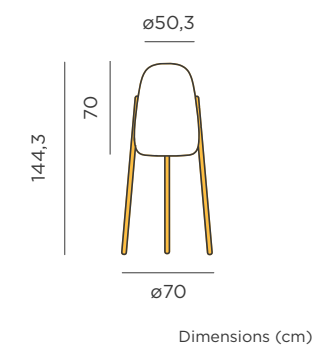

Fity 100.

FITY 100

RECHARGEABLE BATTERY

REF: LUMFT100TWLNW

- IP65 Outdoor & Indoor use
- Rechargeable Battery Electric Charge (driver nor included)
- White Light (included)
- RGB Light (included)
- 110 lm
- Remote control (included)

- Dimmable
- Led tube lighting (included)
- M Polyethylene | Metal (weight stability included)
- Packaging: 19,7 x 19,7 x 102 cm
- Gross Weight (with packaging): 4,7kg

JUTE CABLE

REF: LUMFT1000FNW

- IP65 Outdoor & Indoor use
- White Light (included)
- 1.400 lm
- Led tube lighting (included)

- M Polyethylene | Metal (weight stability included)
- Packaging: 19,7 x 19,7 x 102 cm
- Gross Weight (with packaging): 4,7kg

JUTE CABLE

REF: LUMFT1000CNW

- IP65 Outdoor & Indoor use
- Warm Light (included)
- 1.400 lm
- Led tube lighting (included)

- M Polyethylene | Metal (weight stability included)
- Packaging: 19,7 x 19,7 x 102 cm
- Gross Weight (with packaging): 4,7kg

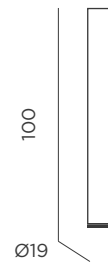

Dimensions (cm)



Fity 160.

FITY 160

RECHARGEABLE BATTERY

REF: LUMFT160TWLNW

- IP54 Outdoor & Indoor use
- Rechargeable Battery Electric Charge (driver nor included)
- White Light (included)
- RGB Light (included)
- 135 lm
- Remote control (included)

- Dimmable
- Led tube lighting (included)
- M Polyethylene | Metal (weight stability included)
- Packaging: 19,5 x 19,5 x 163 cm
- Gross Weight (with packaging): 6,2kg

JUTE CABLE

REF: LUMFT1600FNW

- IP65 Outdoor & Indoor use
- White Light (included)
- 2.200 lm
- Led tube lighting (included)

- M Polyethylene | Metal (weight stability included)
- Packaging: 19,5 x 19,5 x 165 cm
- Gross Weight (with packaging): 6,2kg

JUTE CABLE

REF: LUMFT1600CNW

- IP65 Outdoor & Indoor use
- Warm Light (included)
- 2.200 lm
- Led tube lighting (included)

- M Polyethylene | Metal (weight stability included)
- Packaging: 19,5 x 19,5 x 165 cm
- Gross Weight (with packaging): 6,2kg



Dimensions (cm)





Pancho.

PANCHO 140

RECHARGEABLE BATTERY

- IP54 Outdoor & Indoor use
- Rechargeable Battery Electric Charge (driver not included)
- White Light (included)
- RGB Light (included)
- 115 lm
- Remote control (included)

White | REF: LUMPC140TWLW

- Dimmable
- Led tube lighting (included)
- M Polyethylene
- Packaging: 44 x 51 x 140 cm
- Gross Weight (with packaging): 7kg

CABLE

- IP65 Outdoor & Indoor use
- White Light (included)
- 1800 lm
- Led tube lighting (included)
- M Polyethylene
- Packaging: 44 x 51 x 140 cm
- Gross Weight (with packaging): 7kg

White | REF: LUMPC140OFNW
Lime | REF: LUMPV140OFNW

CABLE

- IP65 Outdoor & Indoor use
- Warm Light (included)
- 1.800 lm
- Led tube lighting (included)

- M Polyethylene
- Packaging: 44 x 51 x 140 cm
- Gross Weight (with packaging): 7kg

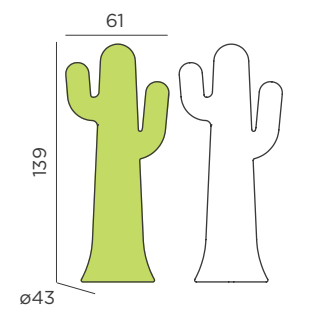

Dimensions (cm)



Lola.



LOLA 200



LOLA 110



Lola 110.

LOLA 110

RECHARGEABLE BATTERY

REF: LUMLL110WLNW

- IP65 Outdoor & Indoor use
- Rechargeable Battery Electric Charge (driver nor included)
- White Light (included)
- RGB Light (included)
- 110 lm
- Remote control (included)

- Dimmable
- Led tube lighting (included)
- M Polyethylene
- Packaging: 27,5 x 27,5 x 112 cm
- Gross Weight (with packaging): 4,2kg

CABLE

REF: LUMLL110OFNW

- IP65 Outdoor & Indoor use
- White Light (included)
- 1.600 lm
- Led tube lighting (included)

- M Polyethylene
- Packaging: 27,5 x 27,5 x 112 cm
- Gross Weight (with packaging): 4,2kg

CABLE

REF: LUMLL110OCNW

- IP65 Outdoor & Indoor use
- Warm Light (included)
- 1.600 lm
- Led tube lighting (included)

- M Polyethylene
- Packaging: 26,5 x 26,5 x 111,5 cm
- Gross Weight (with packaging): 4,2kg

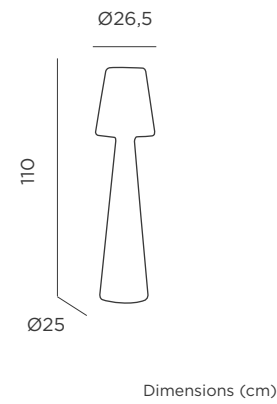

Lola 165.

LOLA 165

RECHARGEABLE BATTERY

REF: LUMLL165WLNW

- IP65 Outdoor & Indoor use
- Rechargeable Battery Electric Charge (driver nor included)
- White Light (included)
- RGB Light (included)
- 135 lm
- Remote control (included)

- Dimmable
- Led tube lighting (included)
- M Polyethylene
- Packaging: 45,5 x 45,5 x 166 cm
- Gross Weight (with packaging): 11kg

CABLE

REF: LUMLL165OFNW

- IP65 Outdoor & Indoor use
- White Light (included)
- 2.200 lm
- Led tube lighting (included)

- M Polyethylene
- Packaging: 45,5 x 45,5 x 166 cm
- Gross Weight (with packaging): 11kg

CABLE

REF: LUMLL165OCNW

- IP65 Outdoor & Indoor use
- Warm Light (included)
- 2.200 lm
- Led tube lighting (included)

- M Polyethylene
- Packaging: 45,5 x 45,5 x 166 cm
- Gross Weight (with packaging): 11kg

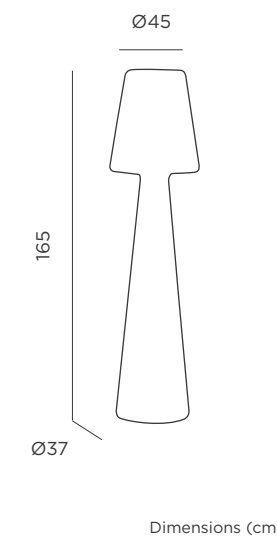

LOLA 165



LOLA 200

Lola 200.

LOLA 200

CABLE

REF: LUMLL200OFNW

- IP65 Outdoor & Indoor use
- White Light (included)
- 2.200 lm
- Led tube lighting (included)

- M Polyethylene
- Packaging: 55,5 x 55,5 x 204 cm
- Gross Weight (with packaging): 17kg

CABLE

REF: LUMLL200OCNW

- IP65 Outdoor & Indoor use
- Warm Light (included)
- 2.200 lm
- Led tube lighting (included)

- M Polyethylene
- Packaging: 55,5 x 55,5 x 204 cm
- Gross Weight (with packaging): 17kg

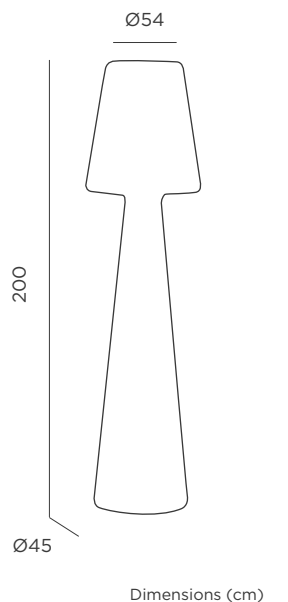

Carmen 110.

CARMEN 110

RECHARGEABLE BATTERY

REF: LUMCR110WLNW

- IP65 Outdoor & Indoor use
- Rechargeable Battery Electric Charge (driver nor included)
- White Light (included)
- RGB Light (included)
- 110 lm
- Remote control (included)

- Dimmable
- Led tube lighting (included)
- M Polyethylene
- Packaging: 31,5 x 31,5 x 112,5 cm
- Gross Weight (with packaging): 4,5kg

CABLE

REF: LUMCR110OFNW

- IP65 Outdoor & Indoor use
- White Light (included)
- 1.600 lm
- Led tube lighting (included)

- M Polyethylene
- Packaging: 31,5 x 31,5 x 112,5 cm
- Gross Weight (with packaging): 4,5kg

CABLE

REF: LUMCR110OCNW

- IP65 Outdoor & Indoor use
- Warm Light (included)
- 1.600 lm
- Led tube lighting (included)

- M Polyethylene
- Packaging: 31,5 x 31,5 x 112,5 cm
- Gross Weight (with packaging): 4,5kg

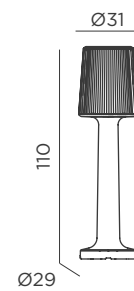

Dimensions (cm)

Carmen 165.

CARMEN 165

RECHARGEABLE BATTERY

REF: LUMCR165WLNW

- IP65 Outdoor & Indoor use
- Rechargeable Battery Electric Charge (driver nor included)
- White Light (included)
- RGB Light (included)
- 135 lm
- Remote control (included)

- Dimmable
- Led tube lighting (included)
- M Polyethylene
- Packaging: 46,4 x 46,4 x 165,5 cm
- Gross Weight (with packaging): 9,5kg

CABLE

REF: LUMCR165OFNW

- IP65 Outdoor & Indoor use
- White Light (included)
- 2.200 lm
- Led tube lighting (included)

- M Polyethylene
- Packaging: 46,4 x 46,4 x 165,5 cm
- Gross Weight (with packaging): 9,5kg

CABLE

REF: LUMCR165OCNW

- IP65 Outdoor & Indoor use
- Warm Light (included)
- 2.200 lm
- Led tube lighting (included)

- M Polyethylene
- Packaging: 46,4 x 46,4 x 165,5 cm
- Gross Weight (with packaging): 9,5kg

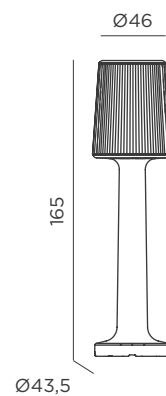

Dimensions (cm)



Fredo.

FREDO 140

RECHARGEABLE BATTERY

REF: LUMFD140TWLNW

- IP65 Outdoor & Indoor use
- Rechargeable Battery Electric Charge (driver nor included)
- White Light (included)
- RGB Light (included)
- 115 lm
- Remote control (included)

- Dimmable
- Led tube lighting (included)
- M Polyethylene
- Packaging: 39 x 39 x 140 cm
- Gross Weight (with packaging): 6kg

CABLE

REF: LUMFD140OFNW

- IP65 Outdoor & Indoor use
- White Light (included)
- 1.800 lm
- Led tube lighting (included)

- M Polyethylene
- Packaging: 39 x 39 x 140 cm
- Gross Weight (with packaging): 6kg

CABLE

REF: LUMFD140OCNW

- IP65 Outdoor & Indoor use
- Warm Light (included)
- 1.800 lm
- Led tube lighting (included)

- M Polyethylene
- Packaging: 39 x 39 x 140 cm
- Gross Weight (with packaging): 6kg

FREDO 170

RECHARGEABLE BATTERY

REF: LUMFD170WLNW

- IP54 Outdoor & Indoor use
- Rechargeable Battery Electric Charge (driver nor included)
- White Light (included)
- RGB Light (included)
- 135 lm
- Remote control (included)

- Dimmable
- Led tube lighting (included)
- M Polyethylene
- Packaging: 48 x 48 x 170 cm
- Gross Weight (with packaging): 8,5kg

CABLE

REF: LUMFD170OFNW

- IP65 Outdoor & Indoor use
- White Light (included)
- 2.200 lm
- Led tube lighting (included)

- M Polyethylene
- Packaging: 48 x 48 x 170 cm
- Gross Weight (with packaging): 8,5kg

CABLE

REF: LUMFD170OCNW

- IP65 Outdoor & Indoor use
- Warm Light (included)
- 2.200 lm
- Led tube lighting (included)

- M Polyethylene
- Packaging: 48 x 48 x 170 cm
- Gross Weight (with packaging): 8,5kg

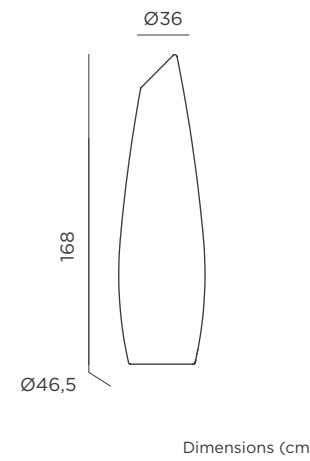
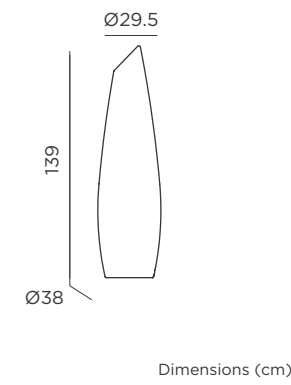

Konika.



KONIKA 170

RECHARGEABLE BATTERY

REF: LUMKN170WLNW

- Outdoor & Indoor use
- Rechargeable Battery Electric Charge (driver not included)
- White Light (included)
- RGB Light (included)
- 135 lm
- Remote control (included)

- Dimmable
- Led tube lighting (included)
- Polyethylene
- Packaging: 45,8 x 45,8 x 171 cm
- Gross Weight (with packaging): 10,3kg

CABLE

REF: LUMKN170OFNW

- Outdoor & Indoor use
- White Light (included)
- 2.200 lm
- Led tube lighting (included)

- Polyethylene
- Packaging: 45,8 x 45,8 x 171 cm
- Gross Weight (with packaging): 10,3kg

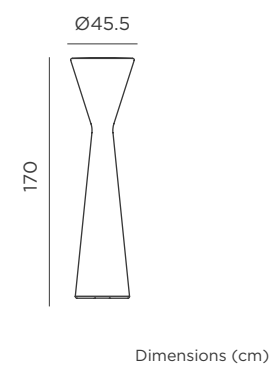

Grace 140.

GRACE 140

🔋 RECHARGEABLE BATTERY

REF: LUMGC140WLNW

- IP54 Outdoor & Indoor use
- 🔋 Rechargeable Battery Electric Charge (driver nor included)
- 💡 White Light (included)
- 🌈 RGB Light (included)
- 💡 115 lm
- 📶 Remote control (included)

- 📏 Dimmable
- 💡 Led tube lighting (included)
- M Polyethylene
- 📦 Packaging: 38 x 38 x 138 cm
- 📦 Gross Weight (with packaging): 6,5kg

🔌 CABLE

REF: LUMGC140OFNW

- IP65 Outdoor & Indoor use
- 💡 White Light (included)
- 💡 1.800 lm
- 💡 Led tube lighting (included)

- M Polyethylene
- 📦 Packaging: 38 x 38 x 138 cm
- 📦 Gross Weight (with packaging): 6,5kg

🔌 CABLE

REF: LUMGC140OCNW

- IP65 Outdoor & Indoor use
- 💡 Warm Light (included)
- 💡 1.800 lm
- 💡 Led tube lighting (included)

- M Polyethylene
- 📦 Packaging: 38 x 38 x 138 cm
- 📦 Gross Weight (with packaging): 6,5kg

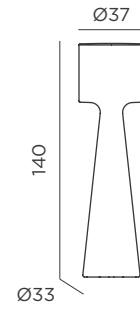

Dimensions (cm)

Grace 170.

GRACE 170

🔋 RECHARGEABLE BATTERY

REF: LUMGC170WLNW

- IP65 Outdoor & Indoor use
- 🔋 Rechargeable Battery Electric Charge (driver nor included)
- 💡 White Light (included)
- 🌈 RGB Light (included)
- 💡 135 lm
- 📶 Remote control (included)

- 📏 Dimmable
- 💡 Led tube lighting (included)
- M Polyethylene
- 📦 Packaging: 46 x 46 x 170 cm
- 📦 Gross Weight (with packaging): 8,5kg

🔌 CABLE

REF: LUMGC170OFNW

- IP65 Outdoor & Indoor use
- 💡 White Light (included)
- 💡 2.200 lm
- 💡 Led tube lighting (included)

- M Polyethylene
- 📦 Packaging: 46 x 46 x 170 cm
- 📦 Gross Weight (with packaging): 8,5kg

🔌 CABLE

REF: LUMGC170OCNW

- IP65 Outdoor & Indoor use
- 💡 Warm Light (included)
- 💡 2.200 lm
- 💡 Led tube lighting (included)

- M Polyethylene
- 📦 Packaging: 46 x 46 x 170 cm
- 📦 Gross Weight (with packaging): 8,5kg

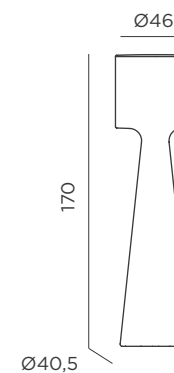

Dimensions (cm)



Kaktus.

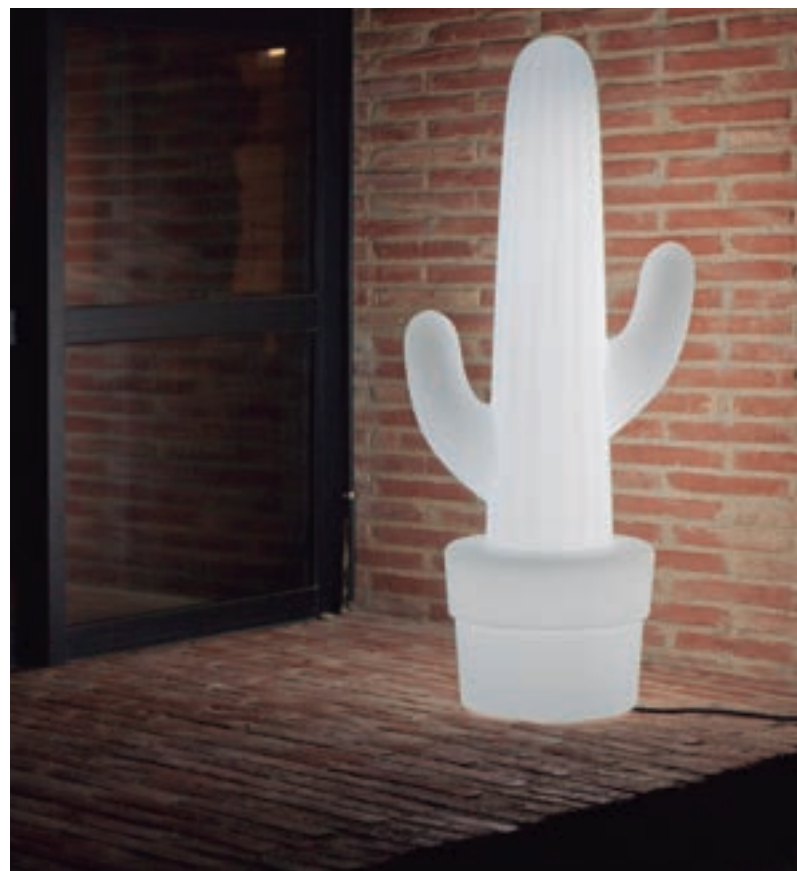

KAKTUS 100

RECHARGEABLE BATTERY

- IP65 Outdoor & Indoor use
- Rechargeable Battery Electric Charge (driver not included)
- White Light (included)
- RGB Light (included)
- 110 lm
- Remote control (included)

White | REF: LUMKL100TDLNW

- Dimmable
- Led tube lighting (included)
- Polyethylene
- Packaging: 34,2 x 34,2 x 101 cm
- Gross Weight (with packaging): 3,7kg

CABLE

- IP65 Outdoor & Indoor use
- White Light (included)
- 1400 lm
- Led tube lighting (included)
- Polyethylene
- Packaging: 34,2 x 34,2 x 101 cm
- Gross Weight (with packaging): 4,1kg

White | REF: LUMKL100DFNW
Lime | REF: LUMKL100DFNW

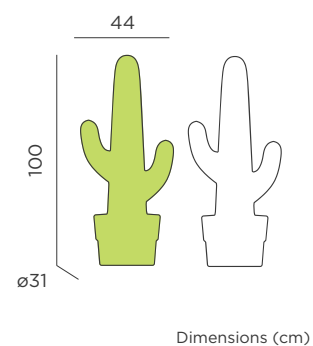

Okinawa Lantern.



Light & Deco | Decorative | Okinawa Lantern

OKINAWA LANTERN | NATURE COLLECTION

☀️ + 🔋 SOLAR & RECHARGEABLE BATTERY

- IP54 Outdoor & Indoor use
- ☀️ Solar + Rechargeable Battery (driver not included)
- 💡 Warm Light (included)
- lm 900 lm
- 📶 Remote control (included)
- 🔊 Dimmable

REF: LUMOKL024XXSLNW

- 🔌 Rechargeable bulb Cherry (included)
- ☀️ Integrated solar panel
- 🎋 Bamboo | Metal Handle (anthracite colour)
- 📦 Packaging: 16 x 16 x 25,5 cm
- 📦 Gross Weight (with packaging): 1,3kg

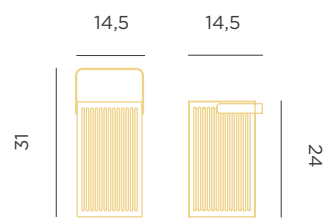

Dimensions (cm)



Siroco 30.

SIROCO 30

RECHARGEABLE BATTERY

REF: LUMSRC030BXWLNW

- IP54 Outdoor & Indoor use
- Rechargeable Battery Electric Charge (driver not included)
- Warm Light Mode
- Flame effect led light Mode
- 200 lm
- Remote control (included)

- Dimmable
- Candy lamp (included)
- Lacquered Iron (black colour)
- Packaging: 31,3 x 19 x 19 cm
- Gross Weight (with packaging): 1,9kg

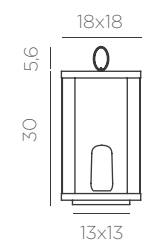

Dimensions (cm)

Siroco 50.

SIROCO 50

RECHARGEABLE BATTERY

REF: LUMSRC050BXWLNW

- IP54 Outdoor & Indoor use
- Rechargeable Battery Electric Charge (driver not included)
- Warm Light Mode
- Flame effect led light Mode
- 200 lm
- Remote control (included)

- Dimmable
- Candy lamp (included)
- Lacquered Iron (black colour)
- Packaging: 51,3 x 19 x 19 cm
- Gross Weight (with packaging): 2,5kg

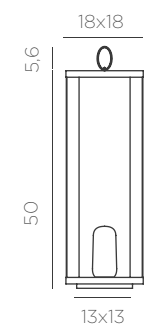

Dimensions (cm)



Hiama.



HIAMA | NATURE COLLECTION

SOLAR

- IP44 Outdoor use
- Solar Battery
- Flame effect led light
- lm 25 lm
- Twilight sensor

REF: LUMHIA120XXSLNW

- Integrated solar panel
- M Bamboo
- Box Packaging: 122 x 52 x 19 cm
- Gross Weight: 0,19kg per unit

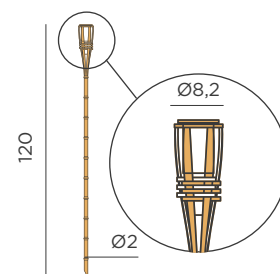

Dimensions (cm)

Greta.

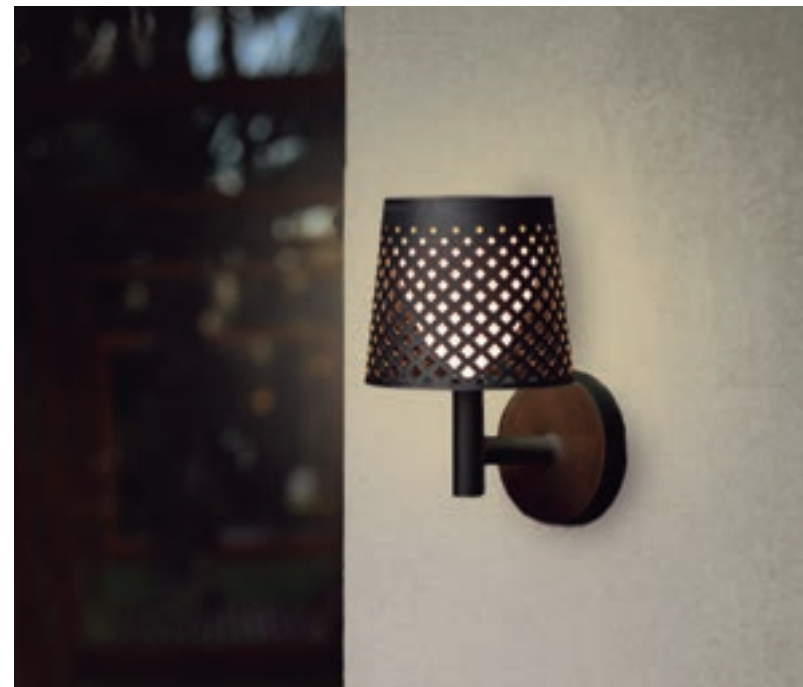

GRETA

SOLAR & RECHARGEABLE BATTERY

- IP65 Outdoor & Indoor use
- Solar + Rechargeable Battery (driver not included)
- Warm Light (included)
- 100 lm
- Twilight sensor
- Touch control
- Recycled Plastic
- Packaging: 23,5 x 22 x 16,5 cm
- Gross Weight (with packaging): 0,7kg

White | REF: LUMGRE080BXSNNW
 Black | REF: LUMGRE080NXSNNW

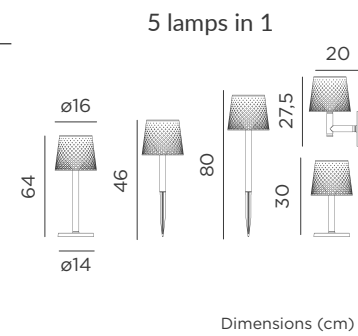

MADE OF RECYCLED MATERIALS

Gretita.

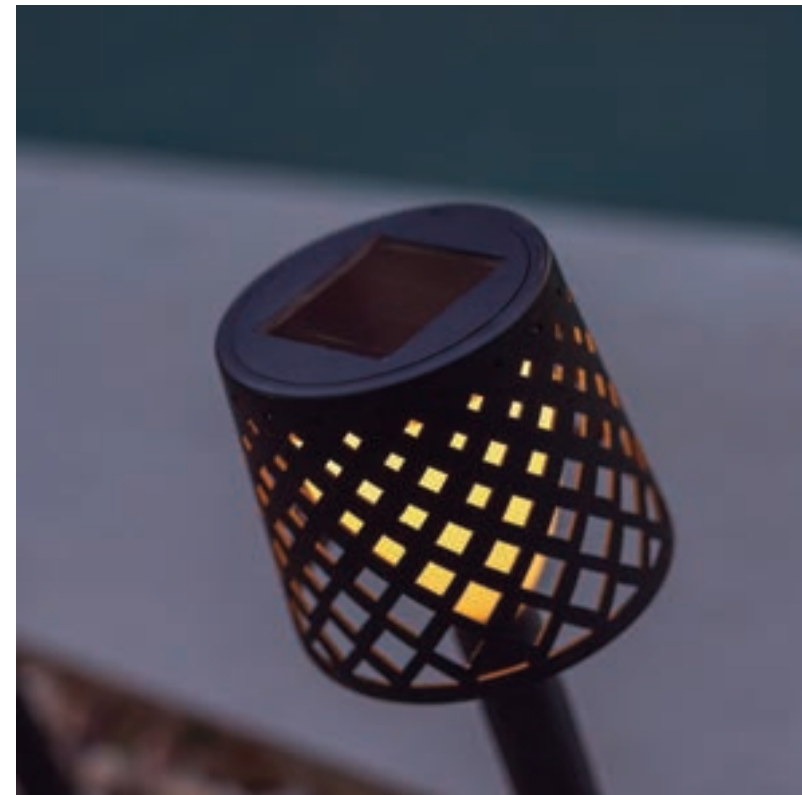

MADE OF RECYCLED
MATERIALS

Light & Deco | Functionals | Gretita



GRETITA

SOLAR

- IP44 Outdoor use
- Solar Battery
- Warm Light (included)
- lm 4 lm
- Twilight sensor
- Integrated solar panel
- Recycled Plastic
- Packaging: 10 x 37 x 12 cm
- Gross Weight (with packaging): 0,6kg

White | ○ REF: LUMGRT039BXSLSNW
Black | ● REF: LUMGRT039NXSLSNW

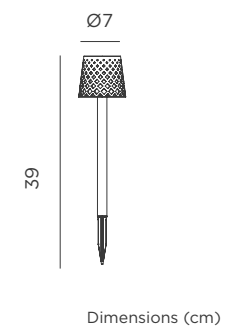

Gretita Table Lamp.



Solar Gretita Table Lamp.



GRETITA TABLE LAMP

AAA BATERIES

- IP44 Outdoor & Indoor use
- 3 AAA batteries (not included)
- Warm Light (included)
- 80 lm
- Touch control
- Dimmable
- Recycled Plastic
- Packaging: 14,2 x 12 x 17,6 cm
- Gross Weight (with packaging): 0,3kg

- White | ○ REF: LUMGRT030BXWLNW
- Antracite | ● REF: LUMGRT030ANWLNW

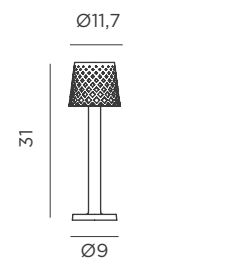

Dimensions (cm)

SOLAR GRETITA TABLE LAMP

SOLAR & RECHARGEABLE BATTERY

- IP44 Outdoor & Indoor use
- Solar + Rechargeable Battery (driver not included)
- Warm Light (included)
- 100 lm
- Dimmable

- Black | ● REF: LUMGTS030NXSWNW

- Integrated solar panel
- Twilight sensor
- Metal | PET
- Packaging: 12,5 x 13,5 x 11,5 cm
- Gross Weight (with packaging): 0,76kg

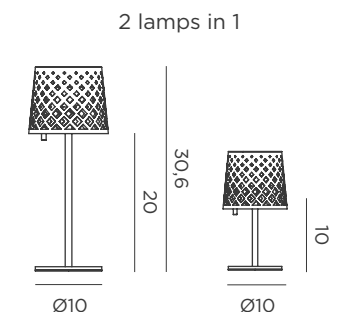

Dimensions (cm)

Conta.

CONTA 70



CONTA 30



MADE OF RECYCLED MATERIALS

Light & Deco | Decorative | Table lamps | Conta

CONTA 30

RECHARGEABLE BATTERY

- IP54 Outdoor & Indoor use
- Rechargeable Battery Electric Charge (driver not included)
- Warm Light (included)
- lm 900 lm
- Remote control (included)

Taupe grey | ● REF: LUMCNT030SXWLNW

- Dimmable
- Rechargeable bulb Cherry (included)
- Recycled Plastic
- Packaging: 27 x 27 x 40 cm
- Gross Weight (with packaging): 1,3kg

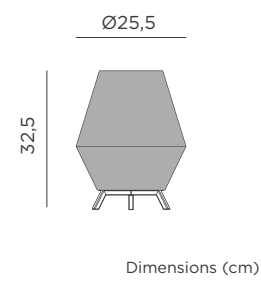

CONTA 70

RECHARGEABLE BATTERY

- IP54 Outdoor & Indoor use
- Rechargeable Battery Electric Charge (driver not included)
- Warm Light (included)
- lm 900 lm
- Remote control (included)

Taupe grey | ● REF: LUMCNT070SXWLNW

- Dimmable
- Rechargeable bulb Cherry (included)
- Recycled Plastic
- Packaging: 50,4 x 50,4 x 74 cm
- Gross Weight (with packaging): 4,3kg

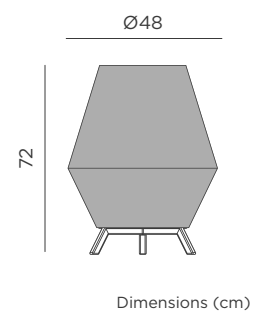

Saona.

SAONA 30



SAONA 70 | 30



SAONA 30 | NATURE COLLECTION

RECHARGEABLE BATTERY

- IP54 Outdoor & Indoor use
- Rechargeable Battery Electric Charge (driver not included)
- Warm Light (included)
- 900 lm
- Remote control (included)

REF: LUMSAO030XXWLNW

- Dimmable
- Rechargeable bulb Cherry (included)
- Rattan
- Packaging: 27 x 27 x 40 cm
- Gross Weight (with packaging): 1,46kg

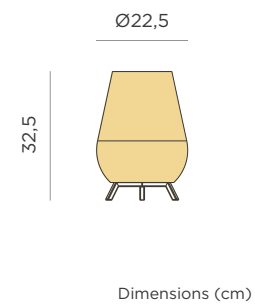

SAONA 70 | NATURE COLLECTION

RECHARGEABLE BATTERY

- IP54 Outdoor & Indoor use
- Rechargeable Battery Electric Charge (driver not included)
- Warm Light (included)
- 900 lm
- Remote control (included)

REF: LUMSAO070XXWLNW

- Dimmable
- Rechargeable bulb Cherry (included)
- Rattan
- Packaging: 50,4 x 50,4 x 74 cm
- Gross Weight (with packaging): 3,34kg

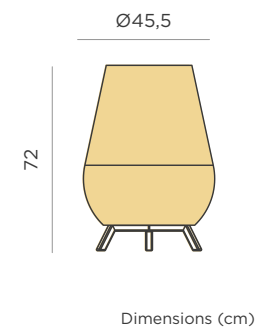

JUTE CABLE

- IP65 Outdoor & Indoor use
- Warm Light (included)
- White Light (included)
- 460 lm
- Remote control (included)

REF: LUMSAO070XXIONW

- Dimmable
- Rattan
- Packaging: 50,4 x 50,4 x 74 cm
- Gross Weight (with packaging): 3,88kg

Dimensions (cm)

Sisine.

SISINE 30



SISINE 70



SISINE 30 | NATURE COLLECTION

RECHARGEABLE BATTERY

- IP54 Outdoor & Indoor use
- Rechargeable Battery Electric Charge (driver not included)
- Warm Light (included)
- lm 900 lm
- Remote control (included)

REF: LUMSIS030XXWLNW

- Dimmable
- Rechargeable bulb Cherry (included)
- M Rattan
- Packaging: 27 x 27 x 40 cm
- Gross Weight (with packaging): 1,37kg

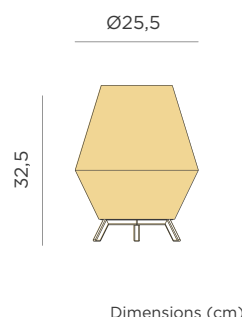

SISINE 70 | NATURE COLLECTION

RECHARGEABLE BATTERY

- IP54 Outdoor & Indoor use
- Rechargeable Battery Electric Charge (driver not included)
- Warm Light (included)
- lm 900 lm
- Remote control (included)

REF: LUMSAO070XXWLNW

- Dimmable
- Rechargeable bulb Cherry (included)
- M Rattan
- Packaging: 50,4 x 50,4 x 74 cm
- Gross Weight (with packaging): 3,34kg

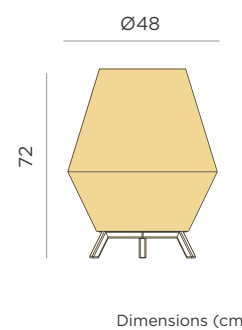

JUTE CABLE

- IP65 Outdoor & Indoor use
- Warm Light (included)
- White Light (included)
- lm 460 lm
- Remote control (included)

REF: LUMSAO070XXIONW

- Dimmable
- M Rattan
- Packaging: 50,4 x 50,4 x 74 cm
- Gross Weight (with packaging): 3,8kg

Bossa 30.



BOSSA 30 | NATURE COLLECTION

🔋 RECHARGEABLE BATTERY

- IP54 Outdoor & Indoor use
- 🔌 Rechargeable Battery Electric Charge (driver not included)
- 💡 Warm Light (included)
- lm 900 lm
- 📶 Remote control (included)

REF: LUMBOS030XXWLNW

- 📏 Dimmable
- 💡 Rechargeable bulb Cherry (included)
- M Rattan
- 📦 Packaging: 27 x 27 x 40 cm
- 📦 Gross Weight (with packaging): 1,2kg

Ø22,5

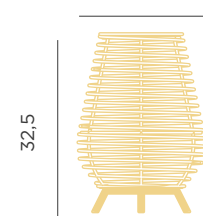

32,5

Dimensions (cm)

Okinawa Table Lamp.



OKINAWA TABLE LAMP | NATURE COLLECTION

🔋 + ☀️ SOLAR & RECHARGEABLE BATTERY

- IP54 Outdoor & Indoor use
- ☀️ Solar + Rechargeable Battery (driver not included)
- 💡 Warm Light (included)
- lm 350 lm
- 📶 Remote control (included)
- 📏 Dimmable

REF: LUMOKT036NWSWNW

- 💡 Rechargeable bulb Mini Cherry (included)
- ☀️ Integrated solar panel
- M Bamboo | Metal (black colour)
- 📦 Packaging: 16,5 x 16,5 x 12 cm
- 📦 Gross Weight (with packaging): 0,9kg

2 lamps in 1

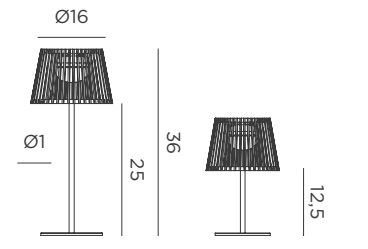

Dimensions (cm)

Chloe 35.



CHLOE 35

☀️ + 🔋 SOLAR & RECHARGEABLE BATTERY

REF: LUMCHLO35SSNW

- IP65 Outdoor & Indoor use
- 🔋 Rechargeable Battery Electric Charge (driver not included)
- ☀️ White Light (included)
- 🌈 RGB Light (included)
- lm 45 lm
- 📱 Remote control (included)

- 📏 Dimmable
- 🌙 Twilight sensor
- 🌳 Beechwood | Polyethylene
- 📦 Packaging: 28,3 x 28,3 x 18 cm
- 📦 Gross Weight (with packaging): 1,8kg

🔌 JUTE CABLE

REF: LUMCHLO35CCNW

- IP44 Outdoor & Indoor use
- 🌈 Warm Light (included)
- lm 500 lm
- 📏 Dimmable

- 👉 Touch control
- 🌳 Beechwood
- 📦 Packaging: 28,3 x 28,3 x 18 cm
- 📦 Gross Weight (with packaging): 1,8kg

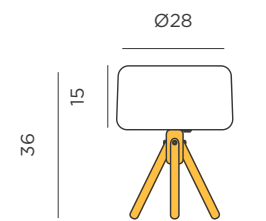

Dimensions (cm)

Jack Lux.



JACK 10 LUX

🔋 RECHARGEABLE BATTERY

REF: LUMJCK010XXWLNW

- IP54 Indoor & outdoor use
- 🔋 Rechargeable Battery Electric Charge (driver not included)
- 🌈 Warm Light Mode (included)
- 🔥 Flame effect led light Mode (included)

- lm 100 lm lamp mode | 20 lm candle mode
- 📏 PS
- 📦 Packaging: 31 x 40 x 12,8 cm
- 📦 Gross Weight (with packaging): 0,228kg

JACK 20 LUX

🔋 RECHARGEABLE BATTERY

REF: LUMJCK020XXWLNW

- IP54 Indoor & outdoor use
- 🔋 Rechargeable Battery Electric Charge (driver not included)
- 🌈 Warm Light Mode (included)
- 🔥 Flame effect led light Mode (included)

- lm 100 lm lamp mode | 20 lm candle mode
- 📏 PS
- 📦 Packaging: 31,8x 41,5 x 23,5 cm
- 📦 Gross Weight (with packaging): 0,342kg

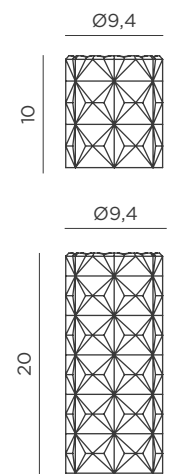

Dimensions (cm)

Lola 12 Lux.



LOLA 12 LUX

REPLACEABLE BATTERY

REF: LUMLOLO12XXAANW

- IP44 Outdoor & Indoor use
- Replaceable battery (Battery CR2032 included)
- Warm Light (included)

- M** PP
- Packaging: ø6,6 x 12 cm
- Gross Weight (with packaging): 0,08kg

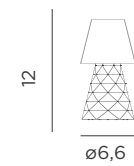

Dimensions (cm)

Lola 20 Lux.



LOLA 20 LUX

RECHARGEABLE BATTERY

REF: LUMLOLO20XXWLNW

- IP44 Outdoor & Indoor use
- Rechargeable Battery Electric Charge (driver not included)
- Warm Light (included)
- lm 120 lm

- Touch control
- M** PMMA
- Packaging: 13,5 x 24,5 x 13,5 cm
- Gross Weight (with packaging): 0,67kg

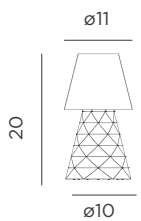

Dimensions (cm)

Shitake.

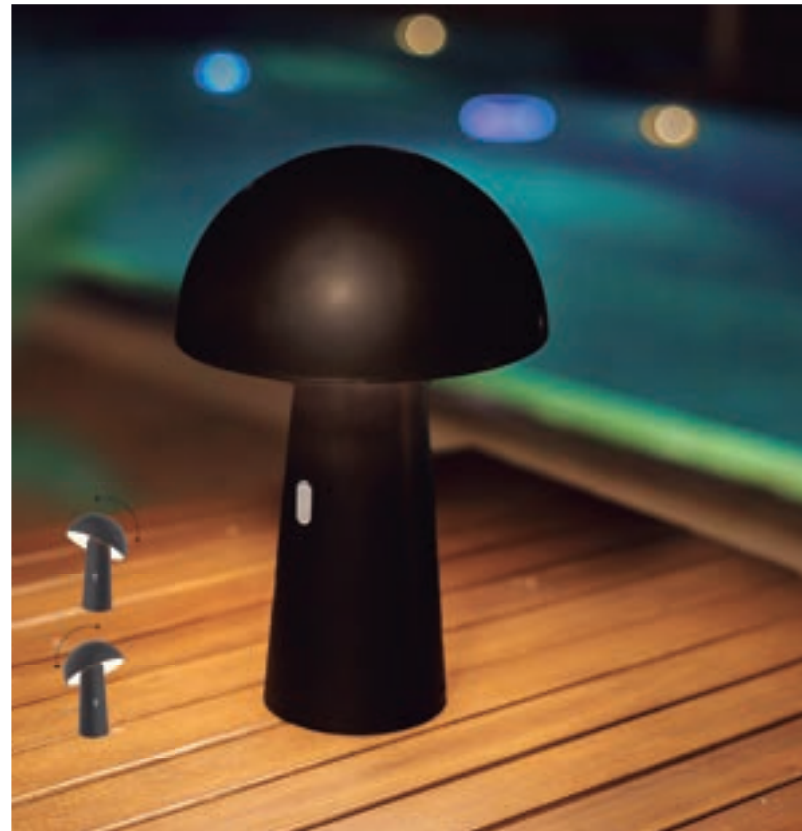

SHITAKE

RECHARGEABLE BATTERY

- IP44 Outdoor & Indoor use
- Rechargeable Battery Electric Charge (driver not included)
- Warm Light (included)
- 450 lm
- Touch control
- ABS
- Packaging: 18,5 x 17 x 26 cm
- Gross Weight (with packaging): 1,03kg

- White | ○ REF: LUMSTK025BXWLNW
- Black | ● REF: LUMSTK025NXWLNW

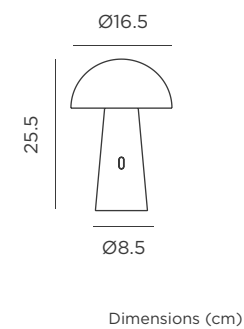

Maia.



MAIA

RECHARGEABLE BATTERY

- IP44 Outdoor & Indoor use
- Rechargeable Battery Electric Charge (driver not included)
- Warm Light (included)
- White Light (included)
- RGB Light (included)
- 100 lm
- Led tube lighting (included)
- ABS
- Packaging: 9,7 x 9,7 x 20,3 cm
- Gross Weight (with packaging): 0,4kg

- Brass | ● REF: LUMMAI019BRWLNW
- Space grey | ● REF: LUMMAI019GEWLNW

Multi Magnetic Charging Base
(Accessory not included)

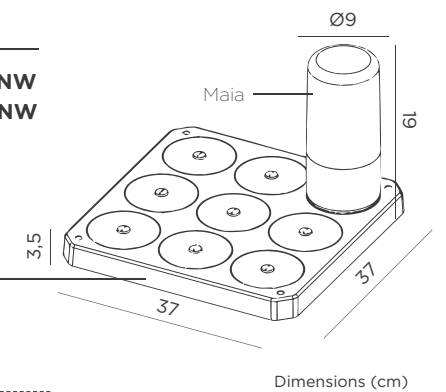

Accessory: Multi Magnetic Charging Base (x9 charging points)

REF: ACCBDC009NXNLNW

- Rechargeable Battery Electric Charge

Sardinia.



SARDINIA 30

RECHARGEABLE BATTERY

- IP44 Outdoor & Indoor use
- 🔋 Rechargeable Battery Electric Charge (driver not included)
- 💡 Warm Light (included)
- lm 400 lm
- 👉 Touch control
- M** Lacquered Iron
- 📦 Packaging: 28 x 18,5 x 4,5 cm
- 📦 Gross Weight (with packaging): 0,7kg

- White | ○ REF: **LUMSDN030BXWLNW**
- Antracite | ● REF: **LUMSDN030ANWLNW**

2 lamps in 1

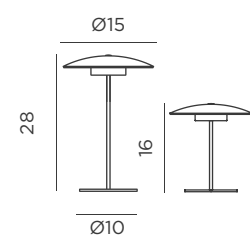

Dimensions (cm)

SARDINIA 40

RECHARGEABLE BATTERY

- IP44 Outdoor & Indoor use
- 🔋 Rechargeable Battery Electric Charge (driver not included)
- 💡 Warm Light (included)
- lm 700 lm
- 👉 Touch control
- M** Lacquered Iron
- 📦 Packaging: 24 x 40,5 x 5,5 cm
- 📦 Gross Weight (with packaging): 1,4kg

- White | ○ REF: **LUMSDN040BXWLNW**
- Antracite | ● REF: **LUMSDN040ANWLNW**

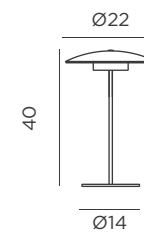

Dimensions (cm)

Candy.



MADE OF RECYCLED
MATERIALS

Light & Deco | Table lamps | Candy



CANDY

🔋 RECHARGEABLE BATTERY

REF: LUMCND019BXWLNW

- IP54 Indoor & outdoor use
- 🔋 Rechargeable Battery Electric Charge (driver not included)
- 💡 Warm Light Mode (included)
- 🔥 Flame effect led light Mode (included)
- 💡 200 lm
- 📶 Remote control (included)

- 📶 Dimmable
- 🧲 Magnetic surface
- ♻️ Recycled Plastic
- 📦 Packaging: 20,5 x 9,2 x 9,2 cm
- 📦 Gross Weight (with packaging): 0,32kg

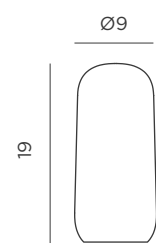

Dimensions (cm)

Norai Slim 35.



NORAI SLIM 35

🔋 RECHARGEABLE BATTERY

- IP44 Outdoor & Indoor use
- 🔌 Rechargeable Battery Electric Charge (driver not included)
- 💡 Warm Light (included)
- lm 160 lm
- 📏 Dimmable
- 👉 Touch control
- M ABS | Metal
- 📦 Packaging: 11,7 x 11,7 x 36 cm
- 📦 Gross Weight (with packaging): 0,6kg

- Anthracite | ● REF: LUMNRS035ANWLNW
- Brass | ● REF: LUMNRS035BRWLNW
- Rose gold | ● REF: LUMNRS035RGWLNW
- Space grey | ● REF: LUMNRS035GEWLNW
- White | ○ REF: LUMNRS035BXWLNW

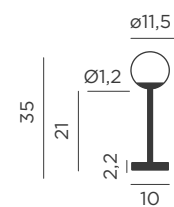

Dimensions (cm)

Lola Slim 30.



LOLA SLIM 30

RECHARGEABLE BATTERY

- IP44 Outdoor & Indoor use
- 🔋 Rechargeable Battery Electric Charge (driver not included)
- 💡 Warm Light (included)
- lm 260 lm
- 🔊 Dimmable
- 👉 Touch control
- M PP Difusor | Metal
- 📦 Packaging: 11,7 x 11,7 x 38 cm
- 📦 Gross Weight (with packaging): 0,47kg

- Anthracite | ● REF: LUMLLS030ANWLNW
- Mint | ● REF: LUMLLS030MNWLNW
- Brass | ● REF: LUMLLS030BRWLNW
- Rose gold | ● REF: LUMLLS030RGWLNW
- Space grey | ● REF: LUMLLS030GEWLNW
- Lime | ● REF: LUMLLS030LIWLNW
- White | ○ REF: LUMLLS030BXWLNW

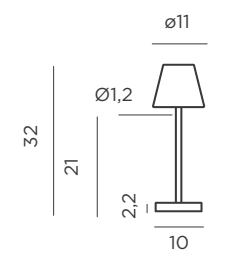

Dimensions (cm)

Rocket 20.



ROCKET 20

RECHARGEABLE BATTERY

REF: LUMRCK20WLNW

- IP43 Outdoor & Indoor use
- Rechargeable Battery Electric Charge (driver not included)
- Warm Light (included)
- lm 11 lm
- Touch control

- Dimmable
- M** Silicone | Wood
- Packaging: 13,5 x 13,5 x 14,5 cm
- Gross Weight (with packaging): 0,35kg

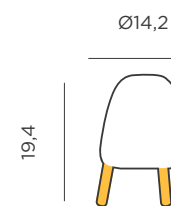

Dimensions (cm)

Panchito.



PANCHITO

RECHARGEABLE BATTERY

White | REF: LUMPCT20WVLNW
Lime | REF: LUMPCT20VVLNW

- IP43 Outdoor & Indoor use
- Rechargeable Battery Electric Charge (driver not included)
- Warm Light (included)
- lm 11 lm
- Touch control
- Dimmable
- M** Silicone
- Packaging: 15,6 x 10 x 21,5 cm
- Gross Weight (with packaging): 0,36kg

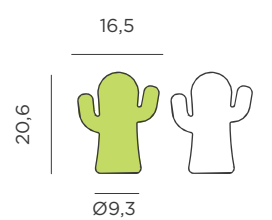

Dimensions (cm)

Lola.

LOLA 20

RECHARGEABLE BATTERY

REF: LUMLL020WLNW

- IP43 Outdoor & Indoor use
- Rechargeable Battery Electric Charge (driver not included)
- White Light (included)
- RGB Light (included)
- 18 lm

- Touch control
- PC
- Packaging: 11,4 x 11,4 x 21,1 cm
- Gross Weight (with packaging): 0,3kg

AAA BATERIES

REF: LUMLL20AAANW

- IP20 Outdoor & Indoor use
- 3 AAA Batteries (not included)
- RGB Light (included)
- 8 lm

- PC
- Packaging: 11,4 x 11,4 x 21,1 cm
- Gross Weight (with packaging): 0,3kg

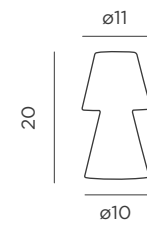

Dimensions (cm)



LOLA 20



LOLA 30

LOLA 30

RECHARGEABLE BATTERY

REF: LUMLL030WLNW

- IP54 Outdoor & Indoor use
- Rechargeable Battery Electric Charge (driver nor included)
- White Light (included)
- RGB Light (included)
- 45 lm
- Remote control (included)

- Dimmable
- Led tube lighting (included)
- Polyethylene
- Packaging: 17 x 17 x 31,6 cm
- Gross Weight (with packaging): 1,2kg

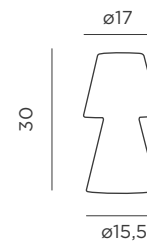

Dimensions (cm)

LOLA 45

RECHARGEABLE BATTERY

REF: LUMLL045WLNW

- IP65 Outdoor & Indoor use
- Rechargeable Battery Electric Charge (driver nor included)
- White Light (included)
- RGB Light (included)
- 360 lm
- Remote control (included)

- Dimmable
- Led tube lighting (included)
- Polyethylene
- Packaging: 26 x 26 x 48 cm
- Gross Weight (with packaging): 1,7kg

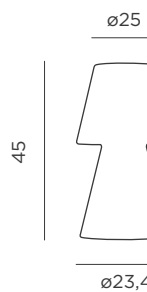

Dimensions (cm)

CABLE

REF: LUMLL045OFNW

- IP65 Outdoor & Indoor use
- White Light (included)
- 600 lm

- Polyethylene
- Packaging: 26 x 26 x 48 cm
- Gross Weight (with packaging): 1,7kg



LOLA 45

Allegra.



ALLEGRA

SOLAR & RECHARGEABLE BATTERY

- IP44 Outdoor & Indoor use
- Rechargeable Battery Electric Charge (driver not included)
- Warm Light (included)
- lm 35 lm (lumens per bulb)
- Solar panel included
- M PVC
- 📦 Packaging: 28,5 x 15 x 15 cm
- 📦 Gross Weight (with packaging): 1,32kg

- White cable | ○ REF: LUMGASBXS LNW
- Jute cable | ● REF: LUMGASXXS LNW
- Black cable | ● REF: LUMGASNXS LNW

JUTE CABLE

- IP44 Outdoor & Indoor use
- Warm Light (included)
- lm 35 lm (lumens per bulb)
- Connectable

- Jute cable | ● REF: LUMGASXXOCNW
- M PVC | Jute cable
- 📦 Packaging: 28,5 x 15 x 15 cm
- 📦 Gross Weight (with packaging): 1,25kg

CABLE (WARM LIGHT)

- IP44 Outdoor & Indoor use
- Warm Light (included)
- lm 35 lm (lumens per bulb)
- Connectable
- M PVC
- 📦 Packaging: 21 x 35 x 12 cm
- 📦 Gross Weight (with packaging): 0,8kg

- White cable | ○ REF: LUMGALLOCBXNW
- Pink cable | ● REF: LUMGALLOCRNW
- Black cable | ● REF: LUMGALLOCNW

CABLE (RGB LIGHT)

- IP44 Outdoor & Indoor use
- White Light (included)
- RGB Light (included)
- lm 35 lm (lumens per bulb)
- Remote control (included)

- Black cable | ● REF: LUMGALLRGBNW
- Connectable
- M PVC
- 📦 Packaging: 28,5 x 15 x 12 cm
- 📦 Gross Weight (with packaging): 0,9kg

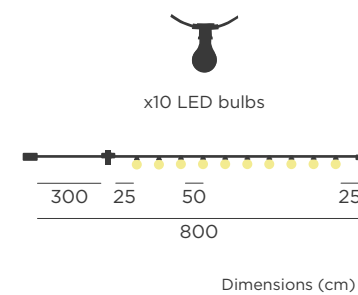





Stella.







STELLA

SOLAR & RECHARGEABLE BATTERY

REF: LUMGSTLSLNW

-  Outdoor & Indoor use
-  Solar + Rechargeable Battery (driver not included)
-  Warm Light (included)
-  35 lm (lumens per bulb)

-  Solar panel included
-  PVC | Transparent cable
-  Packaging: 15 x 20 x 15 cm
-  Gross Weight (with packaging): 0,7kg





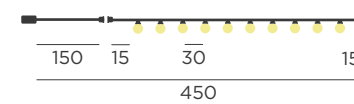

x10 LED bulbs





Dimensions (cm)

CABLE

REF: LUMGSTLOCNW

-  Outdoor & Indoor use
-  Warm Light (included)
-  35 lm (lumens per bulb)
-  Connectable

-  PVC | Transparent cable
-  Packaging: 12 x 20 x 17 cm
-  Gross Weight (with packaging): 0,4kg





Mykonos.







MYKONOS GARLAND

SOLAR, RECHARGEABLE BATTERY & CABLE

REF: LUMMKN800XXSCNW

-  Outdoor & Indoor use
-  Solar + Rechargeable Battery (driver not included)
-  Warm Light (included)
-  35 lumens per bulb

-  Solar panel included
-  Cotton | PVC
-  21 x 25 x 15 cm
-  0,8 kg



x8 LED bulbs + x8 Lampshade

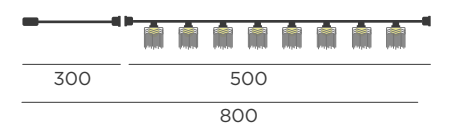

Dimensions (cm)

Aurora.



AURORA | NATURE COLLECTION

SOLAR & RECHARGEABLE BATTERY

- IP44 Outdoor & Indoor use
- Solar + Rechargeable Battery (driver not included)
- Warm Light (included)
- lm 35 lm (lumens per bulb)

REF: LUMAUR800XXSLNW

- Solar panel included
- M** Jute
- Packaging: 15 x 35 x 21cm
- Gross Weight (with packaging): 1,4kg

JUTE CABLE

- IP44 Outdoor & Indoor use
- Warm Light (included)
- lm 35 lm (lumens per bulb)
- Connectable

REF: LUMAUR800XXOCNW

- M** Jute
- Packaging: 12 x 35 x 21 cm
- Gross Weight (with packaging): 0,78kg

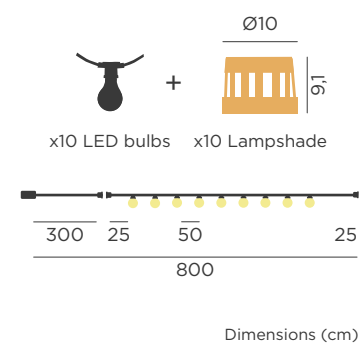

Alba.



ALBA | NATURE COLLECTION

SOLAR & RECHARGEABLE BATTERY

- IP44 Outdoor & Indoor use
- Solar + Rechargeable Battery (driver not included)
- Warm Light (included)
- lm 35 lm (lumens per bulb)

REF: LUMALB800XXSLNW

- Solar panel included
- M** Esparto | Jute cable
- Packaging: 31 x 21,5 x 20,5 cm
- Gross Weight (with packaging): 1,22kg

JUTE CABLE

- IP44 Outdoor & Indoor use
- Warm Light (included)
- lm 35 lm (lumens per bulb)
- Connectable

REF: LUMALB800XXOCNW

- M** Esparto | Jute cable
- Packaging: 31 x 21,5 x 20,5 cm
- Gross Weight (with packaging): 0,8kg

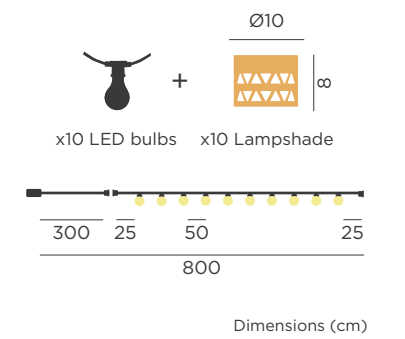

Hiama.



Okinawa.



HIAMA GARLAND | NATURE COLLECTION

- SOLAR**
- IP44 Outdoor use
 - Solar battery
 - Flame effect led light
 - 2 lm (lumens per bulb)

REF: LUMHMG800XXOCNW

- Solar panel included
- M Bamboo | Black cable
- Packaging: 33 x 12 x 11 cm
- Gross Weight (with packaging): 0,43kg

CABLE

- IP44 Outdoor & Indoor use
- Flame effect led light
- 40 lm

REF: LUMHMG800XXSLNW

- M Bamboo | Black cable
- Packaging: 33 x 12 x 11 cm
- Gross Weight (with packaging): 0,41kg

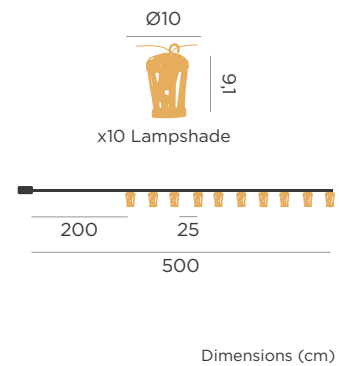

OKINAWA GARLAND | NATURE COLLECTION

- SOLAR & RECHARGEABLE BATTERY**
- IP44 Outdoor & Indoor use
 - Solar +Rechargeable Battery Electric Charge (driver not included)
 - Warm Light (included)
 - 18 lm (lumens per bulb)

REF: LUMOKG800XXSLNW

- Solar panel included
- M Bamboo | Jute cable
- Packaging: 40,5 x 16 x 10,5 cm
- Gross Weight (with packaging): 1kg

JUTE CABLE

- IP44 Outdoor & Indoor use
- Warm Light (included)
- 35 lm (lumens per bulb)
- Connectable

REF: LUMOKG800XXOCNW

- M Bamboo | Jute cable
- Packaging: 40,5 x 16 x 10,5 cm
- Gross Weight (with packaging): 0,9kg

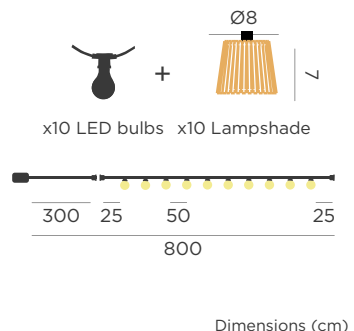





Bruna.







BRUNA

SOLAR & RECHARGEABLE BATTERY

White cable |  REF: LUMGBR100BXSLNW



-  IP44 Outdoor & Indoor use
-  Rechargeable Battery Electric Charge (driver not included)
-  Warm Light (included)
-  50 lm (lumens per bulb)

-  Solar panel included
-  PC
-  Packaging: 15 x 28 x 38 cm
-  Gross Weight (with packaging): 2,44kg

CABLE

White cable |  REF: LUMGBR100BROCNW

-  IP44 Outdoor & Indoor use
-  Warm Light (included)
-  50 lm (lumens per bulb)

-  PC
-  Packaging: 15 x 28 x 38 cm
-  Gross Weight (with packaging): 2,05kg

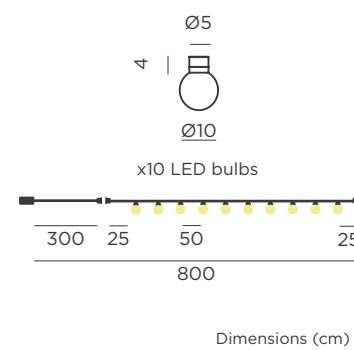

Chelsea.



CHELSEA

CABLE

- IP44 Outdoor & Indoor use
- Warm Light (included)
- 35 lm (lumens per bulb)
- Connectable

REF: LUMCHE800BXOCNW

- M PVC | Black cable
- Packaging: 24,8 x 46,5 x 8,5cm
- Gross Weight (with packaging): 1,66kg

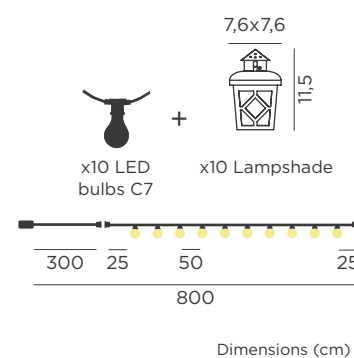

Luceo.



LUCEO 3X2

CABLE

- IP44 Outdoor & Indoor use
- Warm Light (included)
- lm NA
- Connectable

REF: LUMLUC320XXOCNW

- M PVC | Transparent cable
- Packaging: 18 x 18 x 10 cm
- Gross Weight (with packaging): 0,71kg

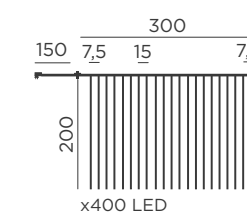

LUCEO 6X3

CABLE

- IP44 Outdoor & Indoor use
- Warm Light (included)
- lm NA

REF: LUMLUC630XXOCNW

- M PVC | Transparent cable
- Packaging: 18 x 18 x 18 cm
- Gross Weight (with packaging): 1,08kg

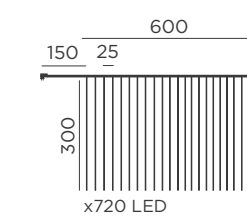

Garland lift.



GARLAND LIFT

Black | ● REF: MOBGLF250NXNW

- M Lacquered Steel
- ↔ Extendable Pole

- 📦 Packaging: 74 x 13 x 6 cm
- 📦 Gross Weight (with packaging): 3.39kg

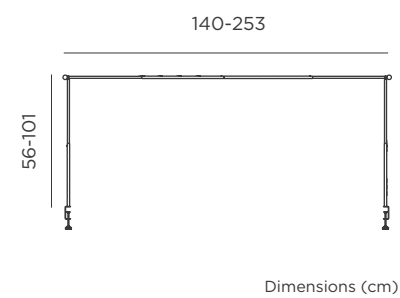

Edy.

EDY G125



EDY A100



EDY A100

RECHARGEABLE BATTERY

- IP54 Outdoor & Indoor use
- Rechargeable Battery Electric Charge (driver not included)
- Warm Light (included)
- Im 200 lm
- Remote control (included)
- Dimmable

Black | ● REF: LUMEDY100NXWLNW

- Hanging product
- Magnetic surface
- Rope: 300 cm
- Recycled Plastic
- Packaging: 11,4 x 11,4 x 26 cm
- Gross Weight (with packaging): 0,5kg

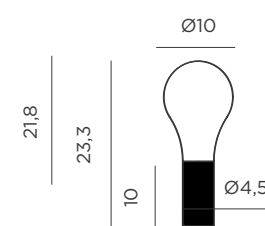

Dimensions (cm)

EDY G125

RECHARGEABLE BATTERY

- IP54 Outdoor & Indoor use
- Rechargeable Battery Electric Charge (driver not included)
- Warm Light (included)
- Im 200 lm
- Remote control (included)
- Dimmable
- Hanging product
- Magnetic surface
- Rope: 300 cm
- Recycled Plastic
- Packaging: 13,2 x 13,2 x 23 cm
- Gross Weight (with packaging): 0,5kg

Black | ● REF: LUMEDY125NXWLNW
 White | ○ REF: LUMEDY125BXWLNW
 Beige | ● REF: LUMEDY125BEWLNW

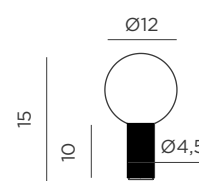

Dimensions (cm)

MADE OF RECYCLED MATERIALS

Conta Mini.



WITHOUT
CABLES



MADE OF RECYCLED
MATERIALS

CONTA MINI

🔋 RECHARGEABLE BATTERY

- IP54 Outdoor & Indoor use
- 🔋 Rechargeable Battery Electric Charge (driver not included)
- 💡 Warm Light (included)
- lm 350 lm
- 📶 Remote control (included)
- 📶 Dimmable
- 🔌 Rechargeable bulb Mini Cherry (included)
- 📏 Hanging product
- Rope: 300 cm
- M Recycled PVC
- 📦 Packaging: 16 x 16 x 16 cm
- 📦 Gross Weight (with packaging): 0,5kg

- White | ○ REF: LUMMCH015BXHWNW
- Taupe | ● REF: LUMMCH015KXHWNW
- Green | ● REF: LUMMCH015VDHWNW

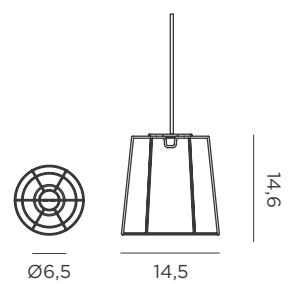

Dimensions (cm)

Neo.



NEO

🔌 CABLE

- IP65 Outdoor & Indoor use
- 💡 Warm Light (included)
- lm 3000 lm
- 7 meters (3m light + 4m cable)

REF: LUMNEO300BXOCNW

- LED Led tube lighting
- M Silicone
- 📦 Packaging: 26,5 X 26,5 X 7 cm
- 📦 Gross Weight (with packaging): 1,5kg

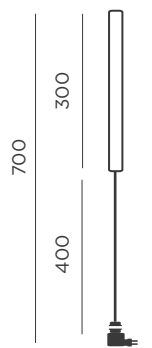







Dimensions (cm)







Elba 39.

ELBA 39

RECHARGEABLE BATTERY

REF: LUMELB039XXHWNW

-  Outdoor & Indoor use
-  Rechargeable Battery Electric Charge (driver not included)
-  Warm Light (included)
-  900 lm
-  Remote control (included)
-  Dimmable

-  Rechargeable bulb Cherry included
-  Hanging product
-  Artificial plants included
-  Polyethylene | Steel cable
-  Packaging: 13 X 40,5 X 47,5 cm
-  Gross Weight (with packaging): 2,8kg

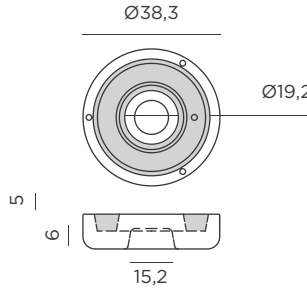







Dimensions (cm)







Elba 59.

ELBA 59

RECHARGEABLE BATTERY

REF: LUMELB059XXHWNW

-  Outdoor & Indoor use
-  Rechargeable Battery Electric Charge (driver not included)
-  Warm Light (included)
-  900 lm
-  Remote control (included)
-  Dimmable

-  Rechargeable bulb Cherry included
-  Hanging product
-  Artificial plants included
-  Polyethylene | Steel cable
-  Packaging: 60,5 x 60,5 x 16,6 cm
-  Gross Weight (with packaging): 4,8kg

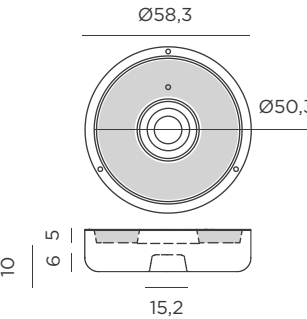

Dimensions (cm)



Mykonos.



MYKONOS HANG

🔋 RECHARGEABLE BATTERY

- IP54 Outdoor & Indoor use
- 🔋 Rechargeable Battery Electric Charge (driver not included)
- 💡 Warm Light (included)
- lm 900 lm
- 📶 Remote control (included)
- 🔊 Dimmable

White | ○ REF: LUMMKNO40XXWLNW

- 🔌 Rechargeable bulb Cherry included
- 🌀 Hanging product
- Rope: 300 cm
- M Cotton
- 📦 Packaging: 32 x 32 x 12 cm
- 📦 Gross Weight (with packaging): 1kg

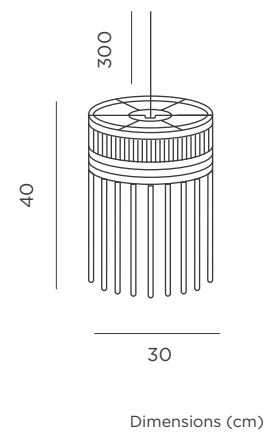

Conta.



CONTA HANG

🔋 RECHARGEABLE BATTERY

Taupe grey | ● REF: LUMCNT030SXHWNW

- 🏠 IP54 Outdoor & Indoor use
- 🔋 Rechargeable Battery Electric Charge (driver not included)
- 💡 Warm Light (included)
- 💡 900 lm
- 📶 Remote control (included)
- 📶 Dimmable

- 🔌 Rechargeable bulb Cherry (included)
- 🌀 Hanging product
- Rope: 300cm
- ♻️ Recycled Plastic
- 📦 Packaging: 45,2 x 44,5 x 33 cm
- 📦 Gross Weight (with packaging): 2,14kg

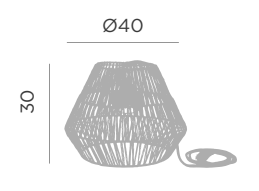

Dimensions (cm)

Positano.



POSITANO

🔋 RECHARGEABLE BATTERY

REF: LUMPOS035XXHXNW

- 🏠 IP54 Outdoor & Indoor use
- 🔋 Rechargeable Battery Electric Charge (driver not included)
- 💡 Warm Light (included)
- 💡 900 lm
- 📶 Remote control (included)
- 📶 Dimmable

- 🔌 Rechargeable bulb Cherry (included)
- 🌀 Hanging product
- Rope: 300cm
- 🌿 Seagrass
- 📦 Packaging: 34,4 x 34,4 x 38,1 cm
- 📦 Gross Weight (with packaging): 1,34kg

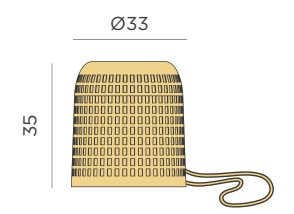







Dimensions (cm)





Okinawa.

OKINAWA HANG | NATURE COLLECTION

RECHARGEABLE BATTERY

-  IP54 Outdoor & Indoor use
-  Rechargeable Battery Electric Charge (driver not included)
-  Warm Light (included)
-  900 lm
-  Remote control (included)
-  Dimmable

REF: LUMOKH040XXHWNW

-  Rechargeable bulb Cherry (included)
-  Hanging product
-  Rope: 300cm
-  M Bamboo
-  Packaging: 39,6 X 39,6 X 31,2 cm
-  Gross Weight (with packaging): 2,6kg

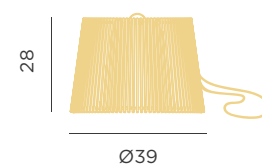

Dimensions (cm)

WITHOUT
CABLES

Bossa.



WITHOUT
CABLES

BOSSA HANG | NATURE COLLECTION

🔋 RECHARGEABLE BATTERY

- IP54 Outdoor & Indoor use
- 🔋 Rechargeable Battery Electric Charge (driver not included)
- 💡 Warm Light (included)
- lm 900 lm
- 📶 Remote control (included)
- 📶 Dimmable

REF: LUMBOHXNW

- 🔌 Rechargeable bulb Cherry (included)
- 📏 Hanging product
- Rope: 300cm
- M** Rattan
- 📦 Packaging: 38,4 x 38,4 x 23 cm
- 📦 Gross Weight (with packaging): 1,5kg

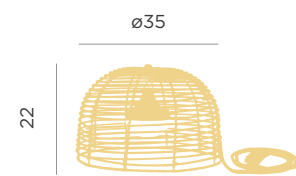

Dimensions (cm)

Sisine.



WITHOUT
CABLES

SISNE HANG | NATURE COLLECTION

🔋 RECHARGEABLE BATTERY

- IP54 Outdoor & Indoor use
- 🔋 Rechargeable Battery Electric Charge (driver not included)
- 💡 Warm Light (included)
- lm 900 lm
- 📶 Remote control (included)
- 📶 Dimmable

REF: LUMSIHXNW

- 🔌 Rechargeable bulb Cherry (included)
- 📏 Hanging product
- Rope: 300cm
- M** Seagrass
- 📦 Packaging: 45,2 x 44,5 x 33 cm
- 📦 Gross Weight (with packaging): 1,8kg



Dimensions (cm)

Calobra.



CALOBRA HANG | NATURE COLLECTION

🔋 RECHARGEABLE BATTERY

- IP54 Outdoor & Indoor use
- 🔋 Rechargeable Battery Electric Charge (driver not included)
- 💡 Warm Light (included)
- lm 900 lm
- 📶 Remote control (included)
- 📶 Dimmable

REF: LUMCAHXNW

- 🔌 Rechargeable bulb Cherry (included)
- 📶 Hanging product
- Rope: 300cm
- M** Rattan
- 📦 Packaging: 38,4 x 38,4 x 19,8 cm
- 📦 Gross Weight (with packaging): 1,4kg

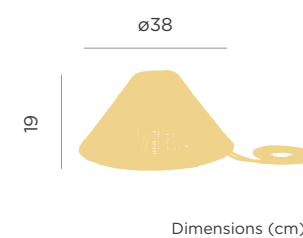

Reona.



REONA | NATURE COLLECTION

🔋 RECHARGEABLE BATTERY

- IP54 Outdoor & Indoor use
- 🔋 Rechargeable Battery Electric Charge (driver not included)
- 💡 Warm Light (included)
- lm 900 lm
- 📶 Remote control (included)
- 📶 Dimmable

REF: LUMREHXNW

- 🔌 Rechargeable bulb Cherry (included)
- 📶 Hanging product
- Rope: 300cm
- M** Bamboo
- 📦 Packaging: 44,5 x 45,2 x 33 cm
- 📦 Gross Weight (with packaging): 1,7kg

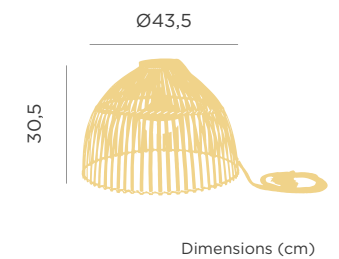

Benirrás.



BENIRRÁS | NATURE COLLECTION

🔋 RECHARGEABLE BATTERY

REF: LUMBEN035XXHXNW

- IP54 Outdoor & Indoor use
- 🔋 Rechargeable Battery Electric Charge (driver not included)
- 💡 Warm Light (included)
- lm 900 lm
- 📶 Remote control (included)
- 📶 Dimmable

- 🔌 Rechargeable bulb Cherry (included)
- 📏 Hanging product
- Rope: 300cm
- M Seagrass
- 📦 Packaging: 34,4 x 34,4 x 38,1 cm
- 📦 Gross Weight (with packaging): 1,35kg

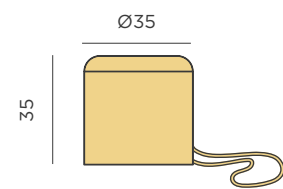

Dimensions (cm)

Saona.



SAONA HANG | NATURE COLLECTION

🔋 RECHARGEABLE BATTERY

REF: LUMSAO050XXHXNW

- IP54 Outdoor & Indoor use
- 🔋 Rechargeable Battery Electric Charge (driver not included)
- 💡 Warm Light (included)
- lm 900 lm
- 📶 Remote control (included)
- 📶 Dimmable

- 🔌 Rechargeable bulb Cherry (included)
- 📏 Hanging product
- Rope: 300cm
- M Rattan
- 📦 Packaging: 32,8 X 32,8 X 51,5 cm
- 📦 Gross Weight (with packaging): 1,95kg

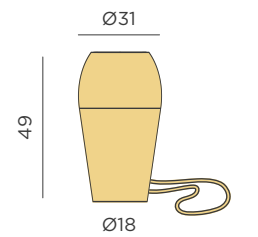

Dimensions (cm)

Pianeta 25 | 35 | 45.

PIANETA 25

RECHARGEABLE BATTERY

REF: LUMPIA025XXHWNW

- IP65 Outdoor & Indoor use
- Rechargeable Battery Electric Charge (driver not included)
- Warm Light (included)
- White Light (included)
- Im 700 lm
- Remote control (included)

- Dimmable
- Hanging product
- Cable: 200 cm
- M Polyethylene | Steel cable
- Packaging: 25,5 x 25,5 x 32 cm
- Gross Weight (with packaging): 1,3kg

HANGING CABLE

REF: LUMPIA025XXHBNW

- IP44 Outdoor & Indoor use
- Warm Light (included)
- White Light (included)
- Im 460 lm
- Remote control (included)
- Dimmable

- Hanging product
- Cable: 200 cm
- M Polyethylene | Steel cable
- Packaging: 25,5 x 25,5 x 35 cm
- Gross Weight (with packaging): 1,38kg

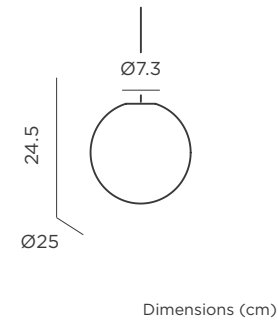

PIANETA 35

RECHARGEABLE BATTERY

REF: LUMPIA035XXHWNW

- IP65 Outdoor & Indoor use
- Rechargeable Battery Electric Charge (driver not included)
- Warm Light (included)
- White Light (included)
- Im 700 lm
- Remote control (included)

- Dimmable
- Hanging product
- Cable: 200 cm
- M Polyethylene | Steel cable
- Packaging: 35,5 x 35,5 x 44 cm
- Gross Weight (with packaging): 1,96kg

HANGING CABLE

REF: LUMPIA035XXHBNW

- IP44 Outdoor & Indoor use
- Warm Light (included)
- White Light (included)
- Im 460 lm
- Remote control (included)
- Dimmable

- Hanging product
- Cable: 200 cm
- M Polyethylene | Steel cable
- Packaging: 35,5 x 35,5 x 44 cm
- Gross Weight (with packaging): 1,73kg

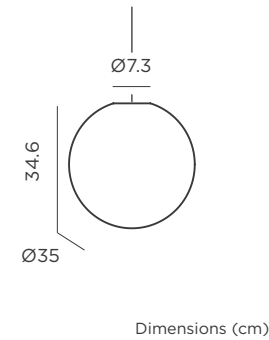

PIANETA 45

RECHARGEABLE BATTERY

REF: LUMPIA045XXHWNW

- IP65 Outdoor & Indoor use
- Rechargeable Battery Electric Charge (driver not included)
- Warm Light (included)
- White Light (included)
- Im 700 lm
- Remote control (included)

- Dimmable
- Hanging product
- Cable: 200 cm
- M Polyethylene | Steel cable
- Packaging: 45,5 x 45,5 x 45,5 cm
- Gross Weight (with packaging): 3,3kg

HANGING CABLE

REF: LUMPIA045XXHBNW

- IP44 Outdoor & Indoor use
- Warm Light (included)
- White Light (included)
- Im 460 lm
- Remote control (included)
- Dimmable

- Hanging product
- Cable: 200 cm
- M Polyethylene | Steel cable
- Packaging: 46 x 46 x 46 cm
- Gross Weight (with packaging): 3,4kg

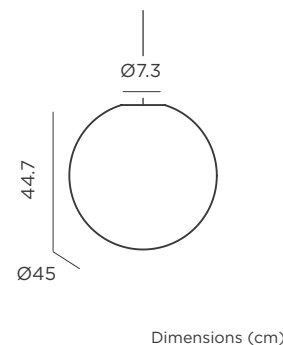

BITA

RECHARGEABLE BATTERY

- IP65 Outdoor & Indoor use
- Rechargeable Battery Electric Charge (driver not included)
- White Light (included)
- RGB Light (included)
- Im 300 lm
- Remote control (included)
- Dimmable
- Hanging product
- Rope: 300 cm
- M ABS
- Packaging: 18,5 x 18,5 x 29,5 cm
- Gross Weight (with packaging): 0,9kg

- Grey rope | ● REF: LUMBITAWLNLW
- Beige rope | ● REF: LUMBITABO3OWLNLW

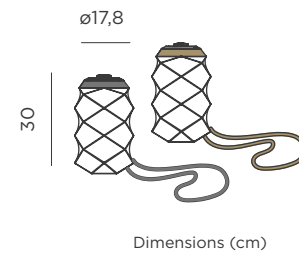

Bitá.



SORA

RECHARGEABLE BATTERY

- IP65 Outdoor & Indoor use
- Rechargeable Battery Electric Charge (driver not included)
- White Light (included)
- RGB Light (included)
- Im 300 lm
- Remote control (included)
- Dimmable
- Hanging product
- Rope: 300 cm
- M ABS
- Packaging: 24,6 x 24,6 x 24,6 cm
- Gross Weight (with packaging): 1kg

- Antracite rope | ● REF: LUMSORAWLNLW
- Beige rope | ● REF: LUMSORABWLNLW

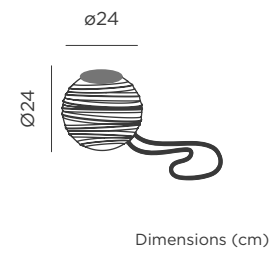

Sora.



NORAI

RECHARGEABLE BATTERY

- IP65 Outdoor & Indoor use
- Rechargeable Battery Electric Charge (driver not included)
- White Light (included)
- RGB Light (included)
- Im 300 lm
- Remote control (included)
- Dimmable
- Hanging product
- Rope: 300 cm
- M ABS
- Packaging: 24,6 x 24,6 x 24,6 cm
- Gross Weight (with packaging): 1kg

- Grey rope | ● REF: LUMNR025WLNW
- Beige rope | ● REF: LUMNRB025WLNW

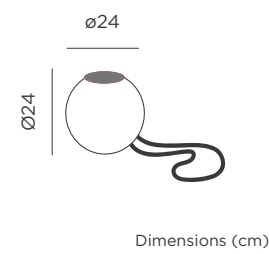

Norai.



Kurby.



KURBY 38

SOLAR & RECHARGEABLE BATTERY

REF: LUMKR038SSNW

- IP65 Outdoor & Indoor use
- Solar + Rechargeable Battery (driver not included)
- Warm Light (included)
- White Light (included)
- RGB Light (included)
- 45 lm

- Remote Control (included)
- Dimmable
- Twilight sensor
- Polyethylene | Vegan leather handle
- Packaging: 28 x 28 x 38,5 cm
- Gross Weight (with packaging): 2kg

KURBY 38 PLAY

RECHARGEABLE BATTERY

REF: LUMKR038PLNW

- IP43 Outdoor & Indoor use
- Rechargeable Battery Electric Charge (driver not included)
- White Light (included)
- RGB Light (included)
- 45 lm
- Remote control (included)

- Dimmable
- Play Music
- x1 Speaker
- Polyurethane | Vegan leather handle
- Packaging: 28 x 28 x 38,5 cm
- Gross Weight (with packaging): 2kg

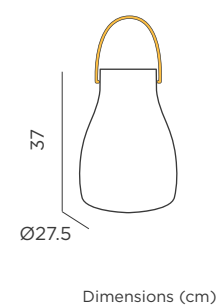



Nómada.

NÓMADA 30

SOLAR & RECHARGEABLE BATTERY

REF: LUMNM032SSNW

- Outdoor & Indoor use
- Solar + Rechargeable Battery (driver not included)
- Warm Light (included)
- White Light (included)
- RGB Light (included)
- 45 lm

- Remote control (included)
- Dimmable
- Twilight sensor
- Polyamide | Metal Handle
- Packaging: 20 x 20 x 31 cm
- Gross Weight (with packaging): 1,28kg

NÓMADA 30 PLAY

RECHARGEABLE BATTERY

REF: LUMNM032PLNW

- Outdoor & Indoor use
- Rechargeable Battery Electric Charge (driver not included)
- White Light (included)
- RGB Light (included)
- 45 lm
- Remote control (included)

- Dimmable
- Play Music
- x1 Speaker
- Polyamide | Metal Handle
- Packaging: 20 x 20 x 31 cm
- Gross Weight (with packaging): 1,3kg

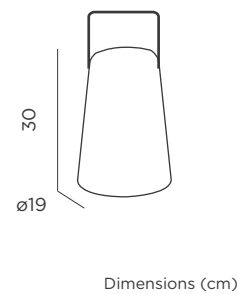

Cuby 45 Play.

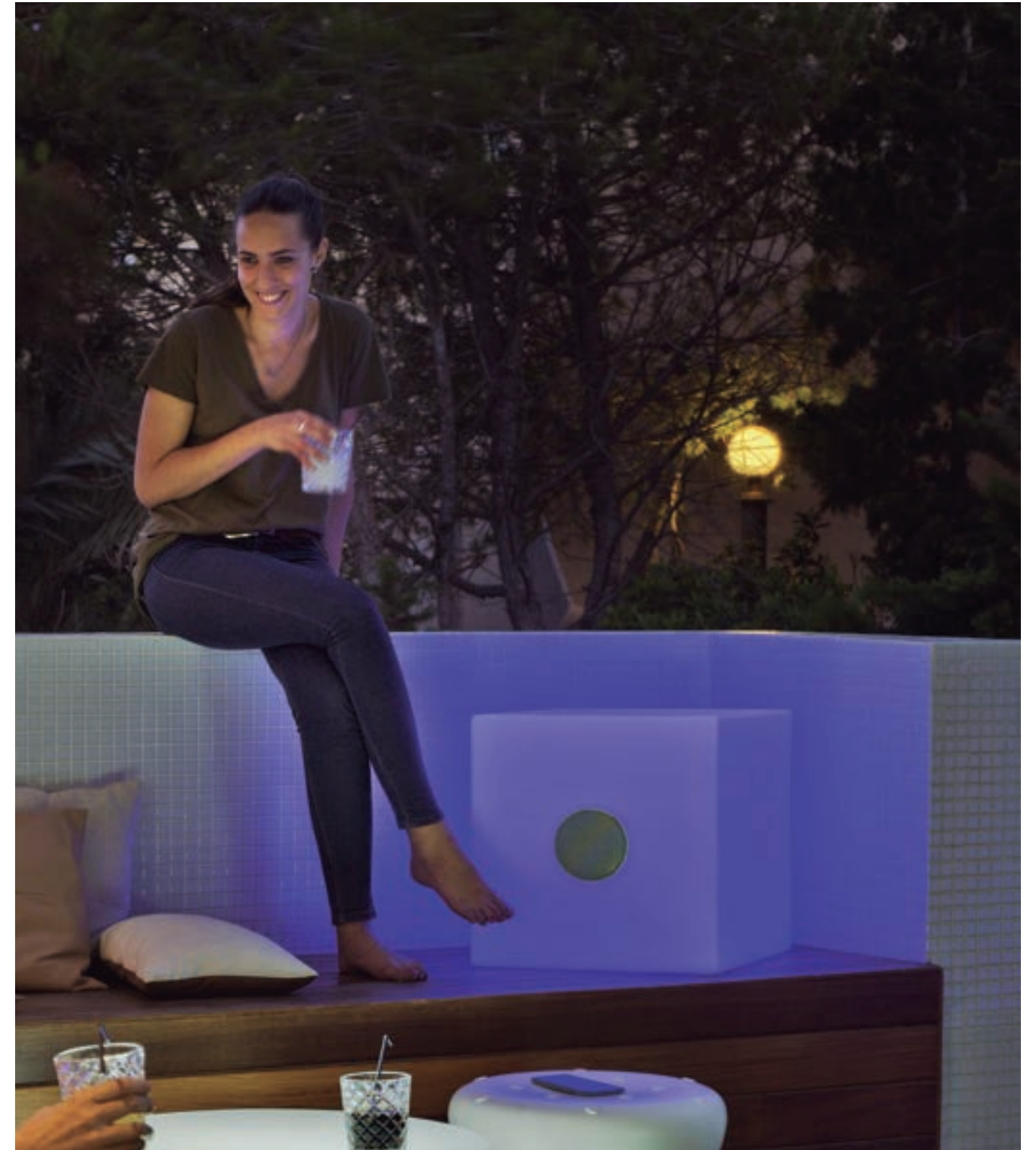

CUBY 45 PLAY

RECHARGEABLE BATTERY

REF: LUMCBP45WLNW

- Outdoor & Indoor use
- Rechargeable Battery Electric Charge (driver not included)
- White Light (included)
- RGB Light (included)
- 45 lm
- Remote control (included)

- Dimmable
- Play music
- x2 Speakers
- Polyethylene
- Packaging: 43,5 x 43,5 x 45 cm
- Gross Weight (with packaging): 5,4kg

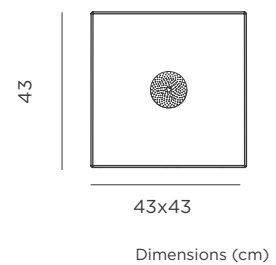

Cherry.



CHERRY

RECHARGEABLE BATTERY

- IP54 Outdoor & Indoor use
- Rechargeable Battery Electric Charge (driver not included)
- Warm Light (included)
- 900 lm
- Remote Control (included)
- Dimmable
- Hanging product
- Magnetic surface
- Recycled Plastic
- Packaging: 11,5 x 11 x 9 cm
- Gross Weight (with packaging): 0,3kg

- White | ○ REF: LUMCHE011BXWLNW
- Beige | ● REF: LUMCHE011BEWLNW

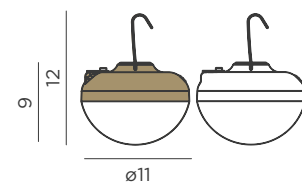

Dimensions (cm)

Solar Cherry.

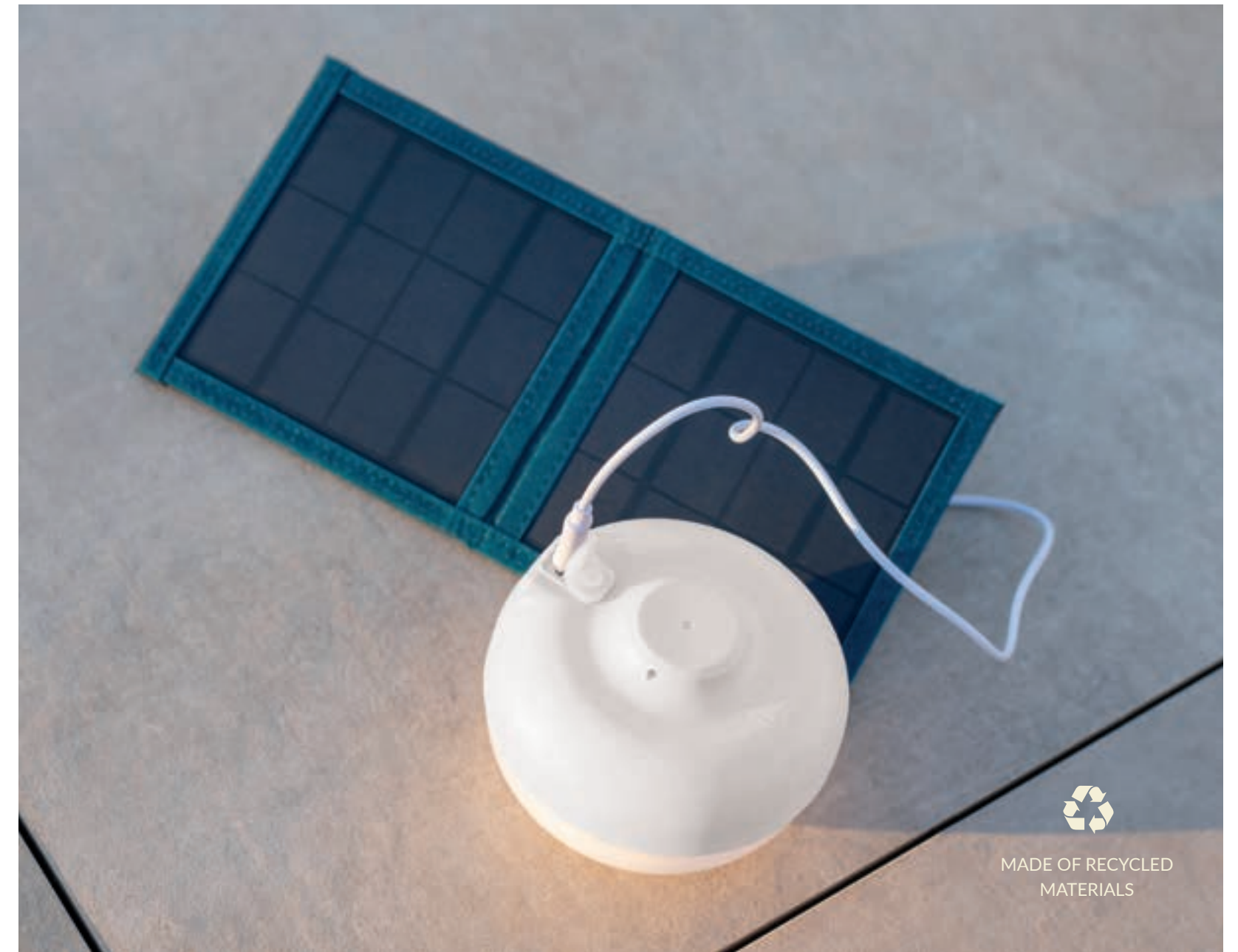

SOLAR CHERRY

SOLAR & RECHARGEABLE BATTERY

- IP54 Outdoor & Indoor use
- Rechargeable Battery Electric Charge (driver not included)
- Warm Light (included)
- 900 lm
- Remote control (included)
- Dimmable
- Hanging product
- Magnetic surface
- Solar panel included
- Recycled Plastic
- Packaging: 13,4 x 13,4 x 10 cm
- Gross Weight (with packaging): 0,46kg

- White | ○ REF: LUMCHS011BXWLNW
- Beige | ● REF: LUMCHS011BEWLNW

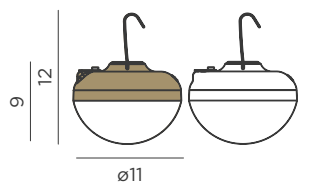

Dimensions (cm)

Cherry Mini.

3 BULBS IN 1

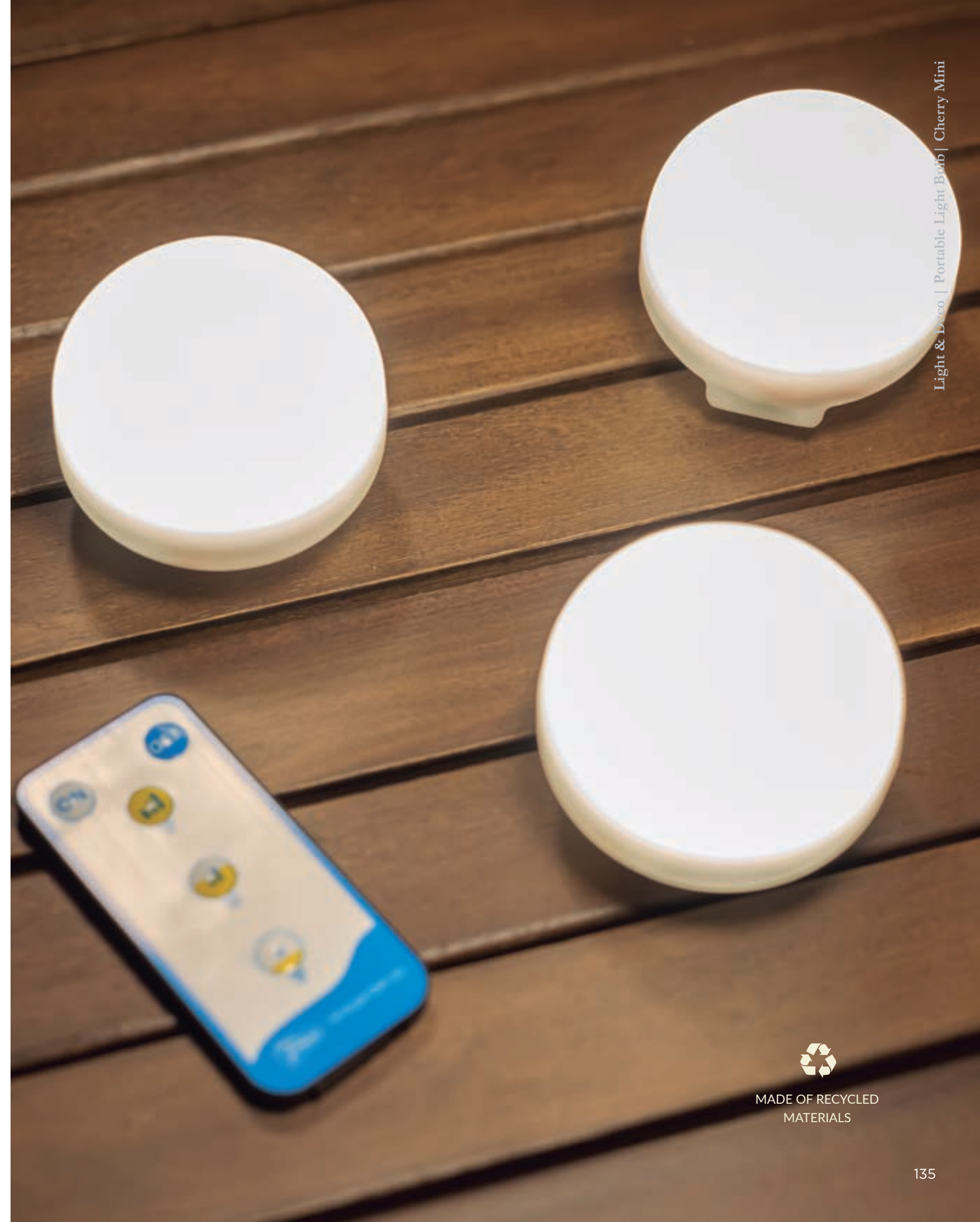

Light & Deco | Portable Light Bulb | Cherry Mini

CHERRY MINI

RECHARGEABLE BATTERY

- IP54 Outdoor & Indoor use
- Rechargeable Battery Electric Charge (driver not included)
- Warm Light (included)
- 350 lm
- Remote control (included)
- Dimmable

White | REF: LUMCHE060BXWLNW

- Hanging product
- Magnetic surface
- Recycled Plastic
- Packaging: 23 x 9 x 6,3 cm
- Gross Weight (with packaging): 0,4kg

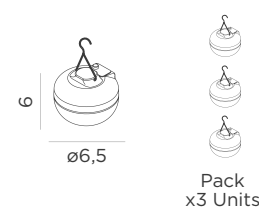

Dimensions (cm)



MADE OF RECYCLED MATERIALS

Coco.



COCO

MAGNETIC PLUG

- IP68 Outdoor & Indoor use
- Magnetic Plug
- Warm Light (included)
- RGB Light (included)
- lm 900 lm
- Remote control (included)

White | ○ REF: LUMCCO011BXFTNW

- Dimmable
- Hanging product
- Floating and submersible
- Recycled Plastic
- Packaging: 11,5 x 9 x 11,5 cm
- Gross Weight (with packaging): 0,5kg

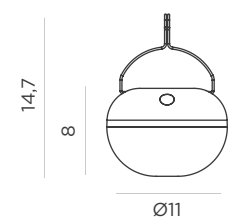

Dimensions (cm)



MADE OF RECYCLED MATERIALS



Banana.

Lima.

MADE OF RECYCLED MATERIALS

MADE OF RECYCLED MATERIALS

BANANA

RECHARGEABLE BATTERY

- IP54 Outdoor & Indoor use
- Rechargeable Battery Electric Charge (driver not included)
- Warm Light (included)
- RGB Light (included)
- 900 lm
- Remote control (included)

White | REF: LUMBNN035BXWLNW

- Dimmable
- Magnetic surface
- Recycled Plastic
- Packaging: 36 x 5 x 5 cm
- Gross Weight (with packaging): 0,4kg

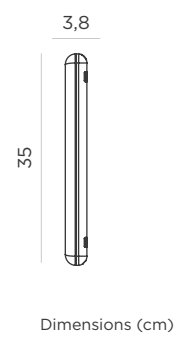

LIMA

RECHARGEABLE BATTERY

- IP54 Outdoor & Indoor use
- Rechargeable Battery Electric Charge (driver not included)
- Warm Light (included)
- RGB Light (included)
- 900 lm
- Magnetic surface

White | REF: LUMLMA020BXWLNW

- Remote control (included)
- Dimmable
- Recycled Plastic
- Packaging: 21 x 21 x 9 cm
- Gross Weight (with packaging): 0,85kg

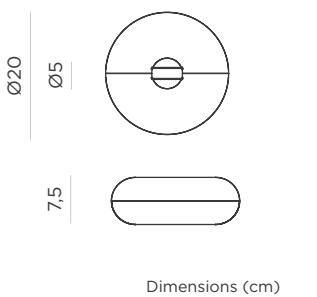

Roll 8.



WITHOUT
CABLES

 MOVABLE



ROLL 8

RECHARGEABLE BATTERY

-  IP20 Outdoor & Indoor use
-  Rechargeable Battery Electric Charge (driver not included)
-  Warm Light (included)
-  300 lm
-  Dimmable
-  Hanging product
-  Magnetic Anchor
-  Without electrical installation
-  Easy Installation (Adhesive Pads or Screws)
-  M ABS
-  Packaging: 8,3 x 8,2 x 8 cm
-  Gross Weight (with packaging): 0,25kg

Black | ● REF: LUMROLO80NXWLNW
White | ○ REF: LUMROLO80BXWLNW

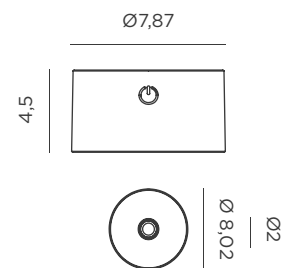

Dimensions (cm)

Compatible with Magnetic Hanging Roll Accessory (sold separately) | pag 142

Roll 4.









WITHOUT
CABLES

 MOVABLE



ROLL 4

RECHARGEABLE BATTERY

-  IP20 Outdoor & Indoor use
-  Rechargeable Battery Electric Charge (driver not included)
-  Warm Light (included)
-  300 lm
-  Dimmable
-  Hanging product
-  Magnetic Anchor
-  Without electrical installation
-  Easy Installation (Adhesive Pads or Screws)
-  M ABS
-  Packaging: 7,7 x 5,4 x 13 cm
-  Gross Weight (with packaging): 0,25kg

Black | ● REF: LUMROLO40NXWLNW
White | ○ REF: LUMROLO40BXWLNW

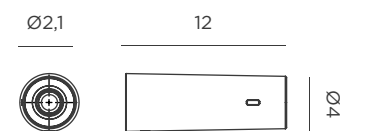

Dimensions (cm)

Compatible with Magnetic Hanging Roll Accessory (sold separately) | pag 142

Roll Accessory.

Box 8.



MAGNETIC HANGING ROLL ACCESSORY

- 🔗 Hanging product
- 🧲 Magnetic Anchor
- 200 cm
- ✂ Without electrical installation
- 🔧 Easy Installation (Adhesive Pads or Screws)
- M** ABS | Metal
- 📦 Packaging: 6 x 6 x 3,5 cm
- 📊 Gross Weight: 0,04kg

- Black | ● REF: ACCRLL200NXNLNW
- White | ○ REF: ACCRLL200BXNLNW

Only for Roll 4 and Roll 8

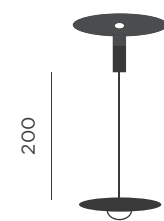

Dimensions (cm)

BOX 8

🔋 RECHARGEABLE BATTERY

- IP20 Outdoor & Indoor use
- 🔋 Rechargeable Battery Electric Charge (driver not included)
- 💡 Warm Light (included)
- lm 300 lm
- 🔊 Dimmable
- 🔗 Hanging product
- 🧲 Magnetic Anchor
- ✂ Without electrical installation
- 🔧 Easy Installation (Adhesive Pads or Screws)
- M** ABS
- 📦 Packaging: 8,5 x 8,2 x 10,8 cm
- 📊 Gross Weight (with packaging): 0,325kg

- Black | ● REF: LUMBOX080NXWLNW
- White | ○ REF: LUMBOX080BXWLNW

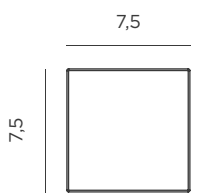

Dimensions (cm)

Pepita.

PEPITA 45

SOLAR & CABLE (HYBRID)

Anthracite | ● REF: LUMPEP045ANSHNW

- Outdoor use
- Solar + Cable
- Warm Light (included)
- lm** 850 lm
- Remote control (included)
- Twilight sensor

- Motion sensor
- Solar panel included
- M** Steel
- Packaging: 16,8 x 46 x 34,3 cm
- Gross Weight (with packaging): 2,5kg

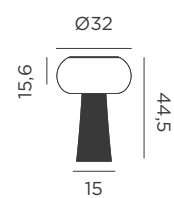

Dimensions (cm)

PEPITA WALL

SOLAR & CABLE (HYBRID)

Anthracite | ● REF: LUMPEP036ANOPNW

- Outdoor use
- Solar + Cable
- Warm Light (included)
- lm** 850 lm
- Remote control (included)
- Twilight sensor

- Motion sensor
- Solar panel included
- M** Steel
- Packaging: 16,8 x 46,1 x 34,3 cm
- Gross Weight (with packaging): 2,36kg

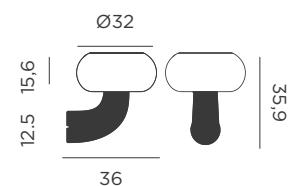

Dimensions (cm)

PEPITA 215 | POST LAMP

SOLAR & CABLE (HYBRID)

Anthracite | ● REF: LUMPEP215ANSHNW

- Outdoor use
- Solar + Cable
- Warm Light (included)
- lm** 1550 lm
- Remote control (included)
- Twilight sensor

- Motion sensor
- Solar panel included
- M** Steel
- Packaging: 59,5 x 54,3 x 103 cm
- Gross Weight (with packaging): 18,5kg

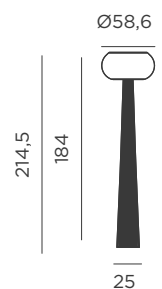

Dimensions (cm)



Paquita.

PAQUITA 40

SOLAR

- IP65 Outdoor use
- Solar Charge
- Warm Light (included)
- 600 lm
- Remote control (included)
- Twilight sensor

Anthracite | ● REF: LUMPQTSMSLNW

- Motion sensor
- Integrated solar panel
- Steel | Anthracite Colour
- Packaging: 15,2 x 40,3 x 32,5 cm
- Gross Weight (with packaging): 3kg

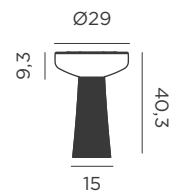

Dimensions (cm)



PAQUITA 40

PAQUITA WALL

SOLAR

- IP65 Outdoor use
- Solar Charge
- Warm Light (included)
- 600 lm
- Remote control (included)
- Twilight sensor

Anthracite | ● REF: LUMPQTAPLSLNW

- Motion sensor
- Integrated solar panel
- Steel | Anthracite Colour
- Packaging: 22,3 x 29,7 x 29,8 cm
- Gross Weight (with packaging): 1,8kg

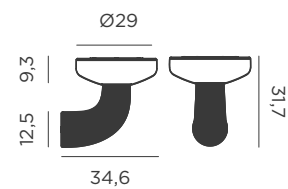

Dimensions (cm)



PAQUITA WALL

PAQUITA 215 | POST LAMP

SOLAR

- IP65 Outdoor use
- Solar Charge
- Warm Light (included)
- 1200 lm
- Remote control (included)
- Twilight sensor

Anthracite | ● REF: LUMPQTFARSLNW

- Motion sensor
- Integrated solar panel
- Steel | Anthracite Colour
- Packaging: 42,5 x 59,3 x 105 cm
- Gross Weight (with packaging): 12,8kg

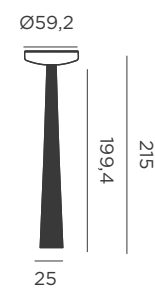

Dimensions (cm)

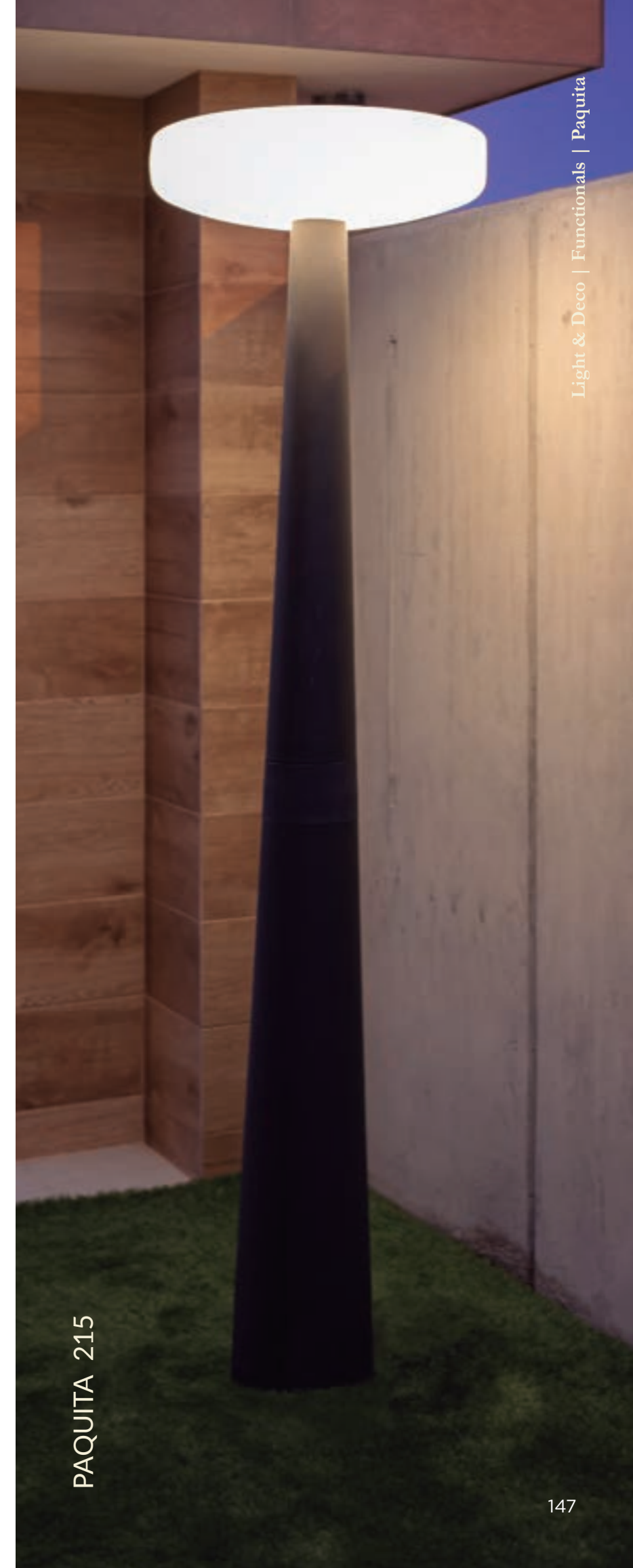

PAQUITA 215

Sunset.



3 levels in 1

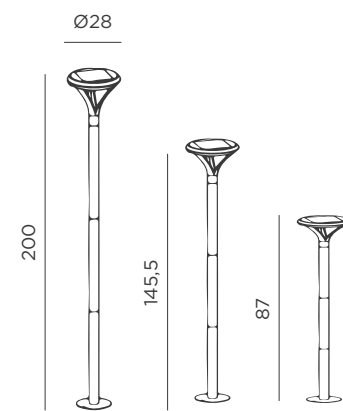

Dimensions (cm)

SUNSET | POST LAMP

SOLAR

- IP65 Outdoor use
- * Solar charging
- ☀ Neutral Light 4000k (included)
- lm 2000 lm
- 🌙 Twilight sensor

Anthracite | ● REF: LUMSNS200SXSLNW

- 👤 Motion sensor
- ☀ Integrated solar panel
- M Aluminium
- 📦 Packaging: 58 x 35 x 28 cm
- 📦 Gross Weight (with packaging): 6,18kg



WALLY SQUARE 12X12X12

SOLAR

- IP65 Outdoor use
- Solar Charge
- Warm Light (included)
- 500 lm
- Remote control (included)
- Twilight sensor

REF: LUMWLC012XXSPNW

- Motion sensor
- Solar panel included
- Recycled Plastic
- Packaging: 13,3 x 13,3 x 13,7 cm
- Gross Weight (with packaging): 0,335kg

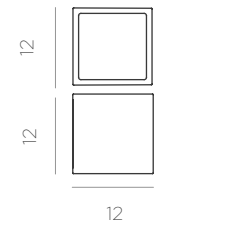

Dimensions (cm)

WALLY SQUARE POT 12X12X12

- IP65 Outdoor use
- Artificial plants included
- 1,33 L

REF: JDNWAP012BXNLNW

- Recycled Plastic
- Packaging: 13,5 x 12,8 x 12,8 cm
- Gross Weight (with packaging): 0,4kg

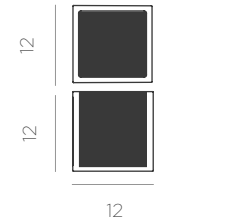

Dimensions (cm)

WALLY RECTANGULAR 12X12X18

SOLAR

- IP65 Outdoor use
- Solar Charge
- Warm Light (included)
- 500 lm
- Remote control (included)
- Twilight sensor

REF: LUMWLP012XXSPNW

- Motion sensor
- Solar panel included
- Recycled Plastic
- Packaging: 13,3 x 13,3 x 19,7 cm
- Gross Weight (with packaging): 0,45kg

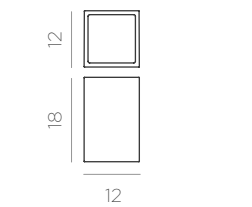

Dimensions (cm)

WALLY SQUARE 18X18X18

SOLAR

- IP65 Outdoor use
- Solar Charge
- Warm Light (included)
- 1000 lm
- Remote control (included)
- Twilight sensor

REF: LUMWLC018XXSPNW

- Motion sensor
- Solar panel included
- Recycled Plastic
- Packaging: 19,3 x 19,3 x 19,7 cm
- Gross Weight (with packaging): 0,72kg

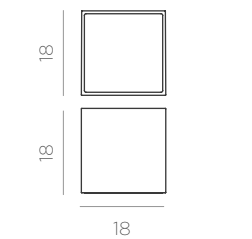

Dimensions (cm)

WALLY SQUARE POT 18X18X18

- IP65 Outdoor use
- Artificial plants included
- 1,8 L

REF: JDNWAP018BXNLNW

- Recycled Plastic
- Packaging: 19,5 x 19 x 19,5 cm
- Gross Weight (with packaging): 0,72kg

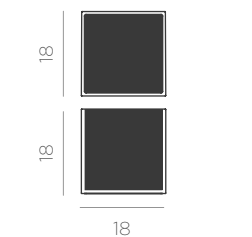

Dimensions (cm)

Wally Square.



MADE OF RECYCLED
MATERIALS

Wally Disk.

WALLY 27 DISK

SOLAR

- IP65 Outdoor use
- Solar Charge
- Warm Light (included)
- lm 200 lm
- Remote control (included)

REF: LUMWLD027XXSPNW

- Twilight sensor
- Integrated solar panel
- M Recycled Plastic
- Packaging: 28 x 6,5 x 28 cm
- Gross Weight (with packaging): 0,65kg

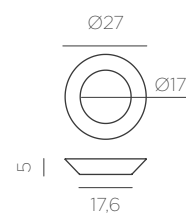

Dimensions (cm)

WALLY 39 DISK

SOLAR

- IP65 Outdoor use
- Solar Charge
- Warm Light (included)
- lm 200 lm
- Remote control (included)

REF: LUMWLD039XXSPNW

- Twilight sensor
- Integrated solar panel
- M Recycled Plastic
- Packaging: 40 x 9,5 x 40 cm
- Gross Weight (with packaging): 1,15kg

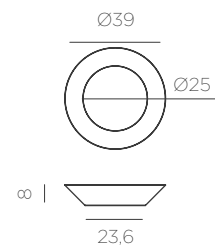

Dimensions (cm)



MADE OF RECYCLED MATERIALS

Bossa.



BOSSA WALL LAMP | NATURE COLLECTION

RECHARGEABLE BATTERY

- IP54 Outdoor & Indoor use
- Rechargeable Battery Electric Charge (driver not included)
- Warm Light (included)
- 900 lm
- Remote control (included)

REF: LUMBOSO25XXWLNW

- Dimmable
- Rechargeable bulb Cherry (included)
- M Rattan
- Packaging: 27,5 X 21,2 X 16,3 cm
- Gross Weight (with packaging): 0,93kg

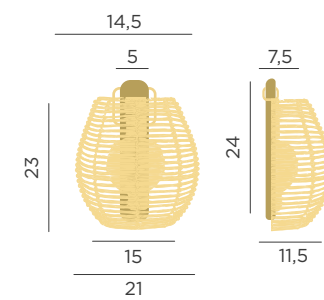

Dimensions (cm)

Sisine.



SISINE 25 WALL LAMP | NATURE COLLECTION

RECHARGEABLE BATTERY

- IP54 Outdoor & Indoor use
- Rechargeable Battery Electric Charge (driver not included)
- Warm Light (included)
- 900 lm
- Remote control (included)

REF: LUMSISO25XXWLNW

- Dimmable
- Rechargeable bulb Cherry (included)
- M Seagrass
- Packaging: 21,2 x 27,2 x 16,3 cm
- Gross Weight (with packaging): 1,37kg

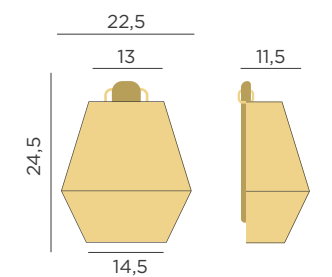

Dimensions (cm)

Saona.



SAONA WALL LAMP | NATURE COLLECTION

🔋 RECHARGEABLE BATTERY

- IP54 Outdoor & Indoor use
- 🔋 Rechargeable Battery Electric Charge (driver not included)
- 💡 Warm Light (included)
- lm 900 lm
- 📱 Remote control (included)

REF: LUMSAO025XXWLNW

- 📏 Dimmable
- 🔋 Rechargeable bulb Cherry (included)
- M Rattan
- 📦 Packaging: 27,5 x 21,2 x 16,3 cm
- 📦 Gross Weight (with packaging): 0,96kg

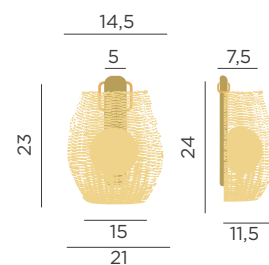

Dimensions (cm)

Conta.



MADE OF RECYCLED MATERIALS

CONTA WALL LAMP

🔋 RECHARGEABLE BATTERY

- IP54 Outdoor & Indoor use
- 🔋 Rechargeable Battery Electric Charge (driver not included)
- 💡 Warm Light (included)
- lm 900 lm
- 📱 Remote control (included)

Taupe grey | ● REF: LUMCNT025SXWLNW

- 📏 Dimmable
- 🔋 Rechargeable bulb Cherry (included)
- M Recycled PVC
- 📦 Packaging: 27,5 x 21,2 x 16,3 cm
- 📦 Gross Weight (with packaging): 1,03kg

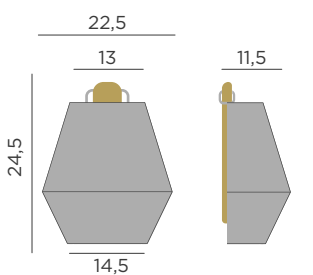

Dimensions (cm)

Buly Collection.



Buly Collection.

BULY

SOLAR & RECHARGEABLE BATTERY

<p>IP65 Outdoor & Indoor use</p> <ul style="list-style-type: none"> Solar + Rechargeable battery Warm Light (included) White Light (included) RGB Light (included) Im 45 lm Remote control (included) Dimmable Twilight sensor M Polyethylene 	Buly 20	<p>REF: LUMBL020SSNW</p> <ul style="list-style-type: none"> Packaging: 20,3 x 20,3 x 19,5 cm Gross Weight (with packaging): 0,71kg 	Buly 50	<p>REF: LUMBL050SSNW</p> <ul style="list-style-type: none"> Packaging: 44,5 x 50,5 x 50,5 cm Gross Weight (with packaging): 3,2kg
	Buly 30	<p>REF: LUMBL030SSNW</p> <ul style="list-style-type: none"> Packaging: 30,3 x 30,3 x 28,5 cm Gross Weight (with packaging): 1,2kg 	Buly 60	<p>REF: LUMBL060SSNW</p> <ul style="list-style-type: none"> Packaging: 56 x 59,5 x 59,5 cm Gross Weight (with packaging): 4,5kg
	Buly 40	<p>REF: LUMBL040SSNW</p> <ul style="list-style-type: none"> Packaging: 36,6 x 40,3 x 40,3 cm Gross Weight (with packaging): 1,9kg 	Buly 80	<p>REF: LUMBL080SSNW</p> <ul style="list-style-type: none"> Packaging: 70,3 x 79,5 x 79,5 cm Gross Weight (with packaging): 9,5kg

SOLAR (FLOATING)

<p>IP68 Outdoor use</p> <ul style="list-style-type: none"> Solar Charge Warm Light (included) White Light (included) RGB Light (included) Im 45 lm Remote control (included) Dimmable Twilight sensor Floating, not submersible M Polyethylene 	Buly 20	<p>REF: LUMBL020FTNW</p> <ul style="list-style-type: none"> Packaging: 20,3 x 20,3 x 19,5 cm Gross Weight (with packaging): 0,8kg
	Buly 30	<p>REF: LUMBL030FTNW</p> <ul style="list-style-type: none"> Packaging: 31,5 x 31,5 x 29 cm Gross Weight (with packaging): 1,2kg
	Buly 40	<p>REF: LUMBL040FTNW</p> <ul style="list-style-type: none"> Packaging: 36,6 x 40,3 x 40,3 cm Gross Weight (with packaging): 1,9kg

SOLAR AUTOMATIC (FLOATING - FULLY AUTONOMOUS)

<p>IP68 Outdoor use</p> <ul style="list-style-type: none"> Solar Charge White Light (included) Im 16 lm Twilight sensor Floating, not submersible M Polyethylene 	Buly 20	<p>REF: LUMBL020SANW</p> <ul style="list-style-type: none"> Packaging: 20,3 x 20,3 x 19,5 cm Gross Weight (with packaging): 0,8kg
--	---------	--

CABLE (WARM LIGHT)

<p>IP65 Outdoor & Indoor use</p> <ul style="list-style-type: none"> Warm Light (included) Im 600 lm Buly 20: 250 lm M Polyethylene 	Buly 20	<p>REF: LUMBL020OCNW</p> <ul style="list-style-type: none"> Packaging: 20,3 x 20,3 x 19,5 cm Gross Weight (with packaging): 0,8kg 	Buly 50	<p>REF: LUMBL050OCNW</p> <ul style="list-style-type: none"> Packaging: 44,5 x 50,5 x 50,5 cm Gross Weight (with packaging): 3,2kg
	Buly 30	<p>REF: LUMBL030OCNW</p> <ul style="list-style-type: none"> Packaging: 31,8 x 31,8 x 29,3 cm Gross Weight (with packaging): 1,2kg 	Buly 60	<p>REF: LUMBL060OCNW</p> <ul style="list-style-type: none"> Packaging: 56 x 59,5 x 59,5 cm Gross Weight (with packaging): 4,5kg
	Buly 40	<p>REF: LUMBL040OCNW</p> <ul style="list-style-type: none"> Packaging: 40,3 x 40,3 x 36,6 cm Gross Weight (with packaging): 1,9kg 	Buly 80	<p>REF: LUMBL080XXICNW</p> <ul style="list-style-type: none"> Packaging: 79,5 x 79,5 x 70,3 cm Gross Weight (with packaging): 9,5kg

CABLE (WHITE LIGHT)

<p>IP65 Outdoor & Indoor use</p> <ul style="list-style-type: none"> White Light (included) Im 600 lm Buly 20: 250 lm M Polyethylene 	Buly 20	<p>REF: LUMBL020OFNW</p> <ul style="list-style-type: none"> Packaging: 20,3 x 20,3 x 19,5 cm Gross Weight (with packaging): 0,8kg 	Buly 50	<p>REF: LUMBL050OFNW</p> <ul style="list-style-type: none"> Packaging: 50,8 x 50,8 x 45,3cm Gross Weight (with packaging): 3,2kg
	Buly 30	<p>REF: LUMBL030OFNW</p> <ul style="list-style-type: none"> Packaging: 31,5 x 31,5 x 29 cm Gross Weight (with packaging): 1,2kg 	Buly 60	<p>REF: LUMBL060OFNW</p> <ul style="list-style-type: none"> Packaging: 60 x 60 x 57 cm Gross Weight (with packaging): 4,5kg
	Buly 40	<p>REF: LUMBL040OFNW</p> <ul style="list-style-type: none"> Packaging: 40,3 x 40,3 x 36,6 cm Gross Weight (with packaging): 1,9kg 	Buly 80	<p>REF: LUMBL080OFNW</p> <ul style="list-style-type: none"> Packaging: 79,5 x 79,5 x 70,3 cm Gross Weight (with packaging): 9,5kg

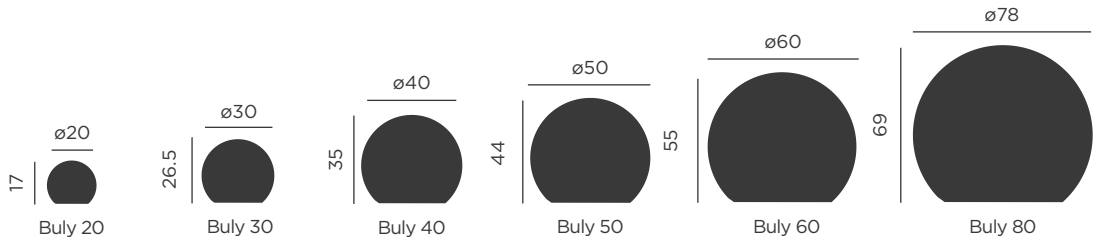







Dimensions (cm)







Petra.

PETRA 40

SOLAR & RECHARGEABLE BATTERY



REF: LUMPT040SSNW





-  Outdoor & Indoor use
-  Solar + Rechargeable Battery (driver not included)
-  Warm Light (included)
-  White Light (included)
-  RGB Light (included)
-  45 lm
-  Remote control (included)

-  Dimmable
-  Twilight sensor
-  Solar panel included
-  Polyethylene
-  Packaging: 29,5 x 40,3 x 20,5 cm
-  Gross Weight (with packaging): 1,3kg

SOLAR AUTOMATIC



REF: LUMPT040SANW



-  Outdoor use
-  Solar Charge
-  White light (included)
-  16 lm
-  Twilight sensor

-  Solar panel included
-  Polyethylene
-  Packaging: 29,5 x 40,3 x 20,5 cm
-  Gross Weight (with packaging): 1,3kg

CABLE

REF: LUMPT040OFNW

-  Outdoor & Indoor use
-  White light (included)
-  250 lm



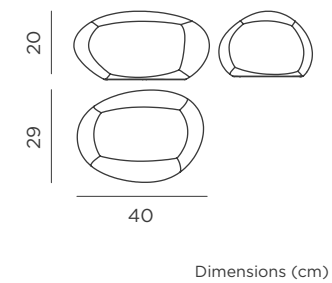



-  Polyethylene
-  Packaging: 29,5 x 40,3 x 20,5 cm
-  Gross Weight (with packaging): 1,3kg









PETRA 60

SOLAR & RECHARGEABLE BATTERY

REF: LUMPT060SSNW



-  Outdoor & Indoor use
-  Solar + Rechargeable Battery (driver not included)
-  Warm Light (included)
-  White Light (included)
-  RGB Light (included)
-  45 lm
-  Remote control (included)

-  Dimmable
-  Twilight sensor
-  Solar panel included
-  Polyethylene
-  Packaging: 44,3 x 60,2 x 30,8 cm
-  Gross Weight (with packaging): 2,5kg

CABLE

REF: LUMPT060OFNW

-  Outdoor & Indoor use
-  White light (included)
-  600 lm

-  Polyethylene
-  Packaging: 44,3 x 60,2 x 30,8 cm
-  Gross Weight (with packaging): 3kg

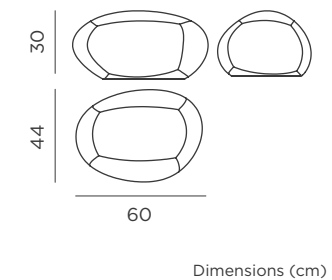

Cuby Collection.

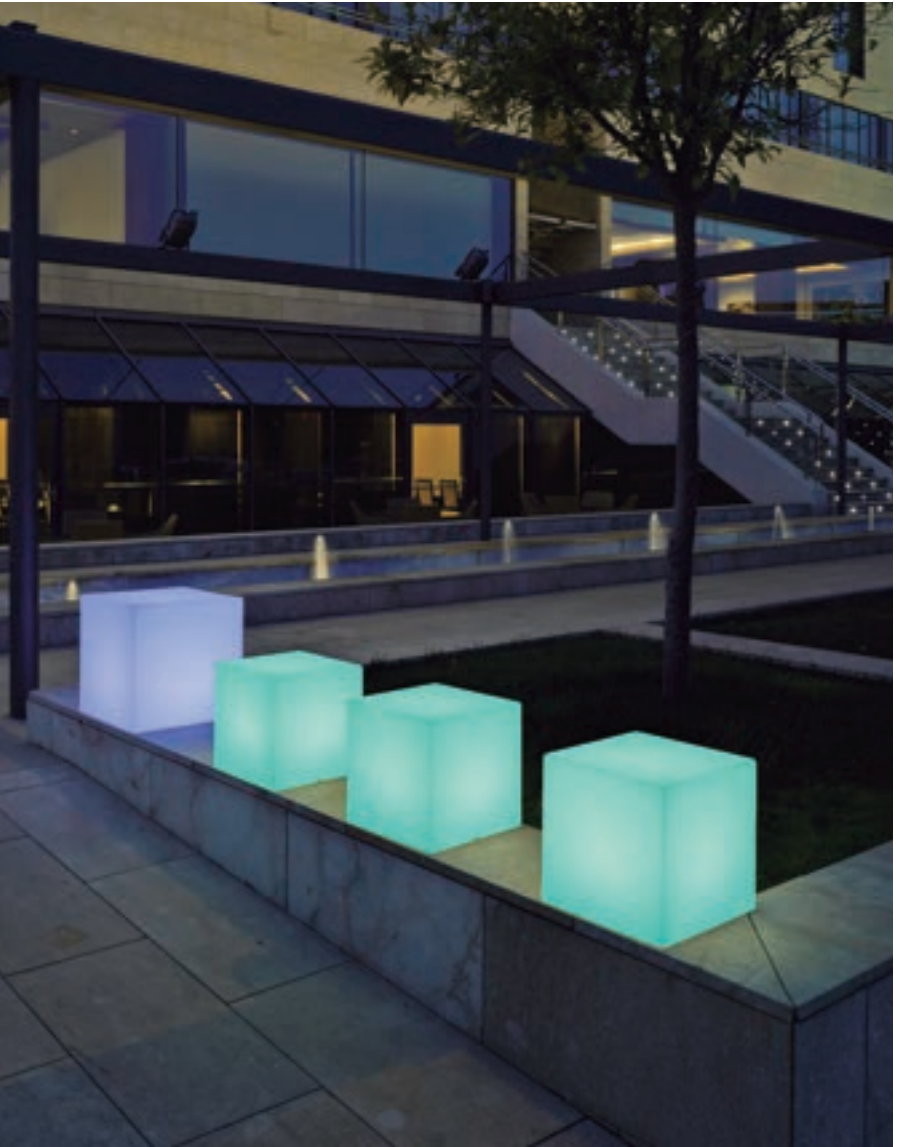

CUBY

SOLAR & RECHARGEABLE BATTERY

- IP65 Outdoor & Indoor use
- Solar + Rechargeable battery
- Warm Light (included)
- White Light (included)
- RGB Light (included)
- 45 lm
- Remote control (included)
- Dimmable
- Twilight sensor
- M Polyethylene

Cuby 20	REF: LUMCB020SSNW ☒ Packaging: 26,5 x 30,3 x 30,3 cm 📦 Gross Weight (with packaging): 1,1kg
Cuby 32	REF: LUMCB032SSNW ☒ Packaging: 34,8 x 32,5 x 32,5 cm 📦 Gross Weight (with packaging): 2,7kg
Cuby 40	REF: LUMCB040SSNW ☒ Packaging: 42 x 40,6 x 40,6 cm 📦 Gross Weight (with packaging): 4kg

Cuby 45	REF: LUMCB045SSNW ☒ Packaging: 45 x 43,5 x 43,5 cm 📦 Gross Weight (with packaging): 5kg
Cuby 53	REF: LUMCB053SSNW ☒ Packaging: 43,6 x 43,6 x 55 cm 📦 Gross Weight (with packaging): 5,5kg

CABLE (WARM LIGHT)

- IP65 Outdoor & Indoor use
- Warm Light (included)
- 600 lm
- M Polyethylene

Cuby 32	REF: LUMCB032OCNW ☒ Packaging: 34,8 x 32,5 x 32,5 cm 📦 Gross Weight (with packaging): 2,7kg
Cuby 40	REF: LUMCB040CFNW ☒ Packaging: 42 x 40,6 x 40,6 cm 📦 Gross Weight (with packaging): 4kg

Cuby 45	REF: LUMCB045OCNW ☒ Packaging: 45 x 43,5 x 43,5 cm 📦 Gross Weight (with packaging): 5kg
---------	--

CABLE (WHITE LIGHT)

- IP65 Outdoor & Indoor use
- White Light (included)
- 600 lm | Cuby 20: 250 lm
- M Polyethylene

Cuby 20	REF: LUMCB020OFNW ☒ Packaging: 26,5 x 30,3 x 30,3 cm 📦 Gross Weight (with packaging): 1,1kg
Cuby 32	REF: LUMCB032OFNW ☒ Packaging: 34,8 x 32,5 x 32,5 cm 📦 Gross Weight (with packaging): 2,7kg
Cuby 40	REF: LUMCB040OFNW ☒ Packaging: 42 x 40,6 x 40,6 cm 📦 Gross Weight (with packaging): 4,5kg

Cuby 45	REF: LUMCB045OFNW ☒ Packaging: 45 x 43,5 x 43,5 cm 📦 Gross Weight (with packaging): 5kg
Cuby 53	REF: LUMCB053OFNW ☒ Packaging: 43,6 x 43,6 x 55 cm 📦 Gross Weight (with packaging): 5,5kg

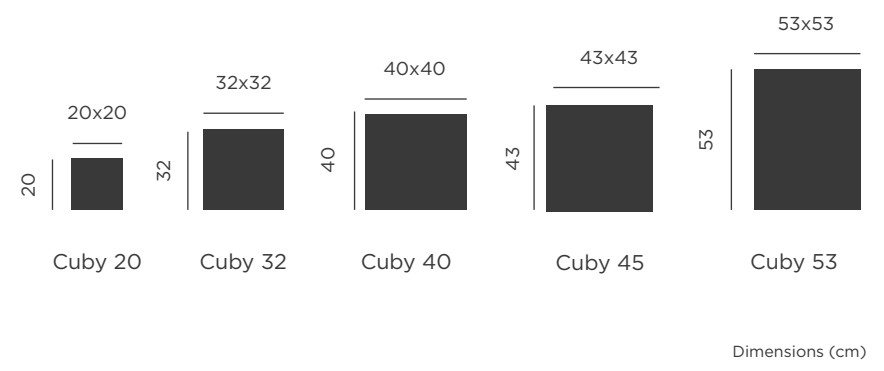

special for
Swimming-pool



Papaya 12.

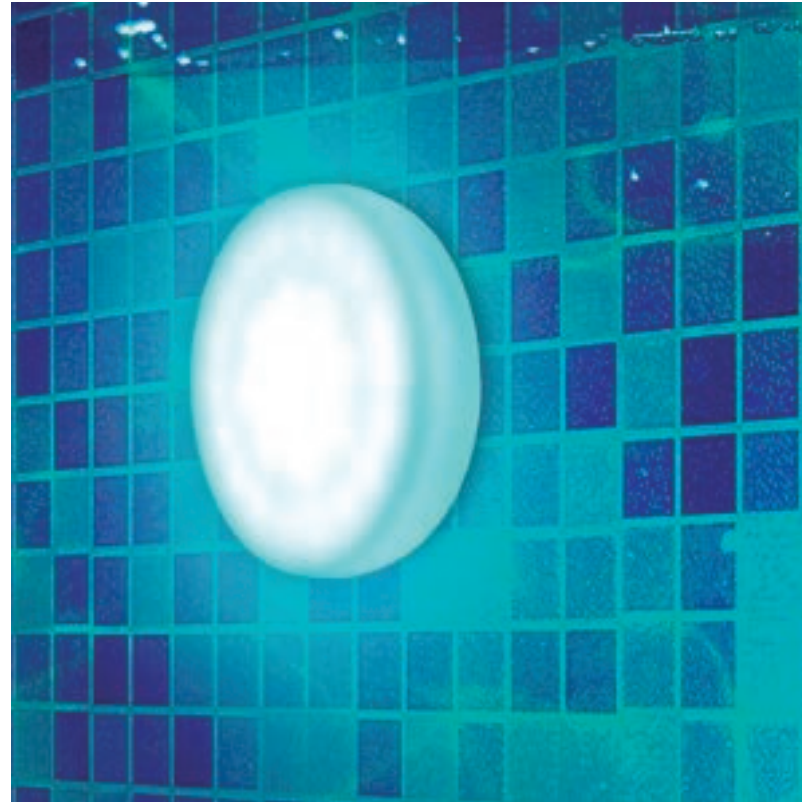
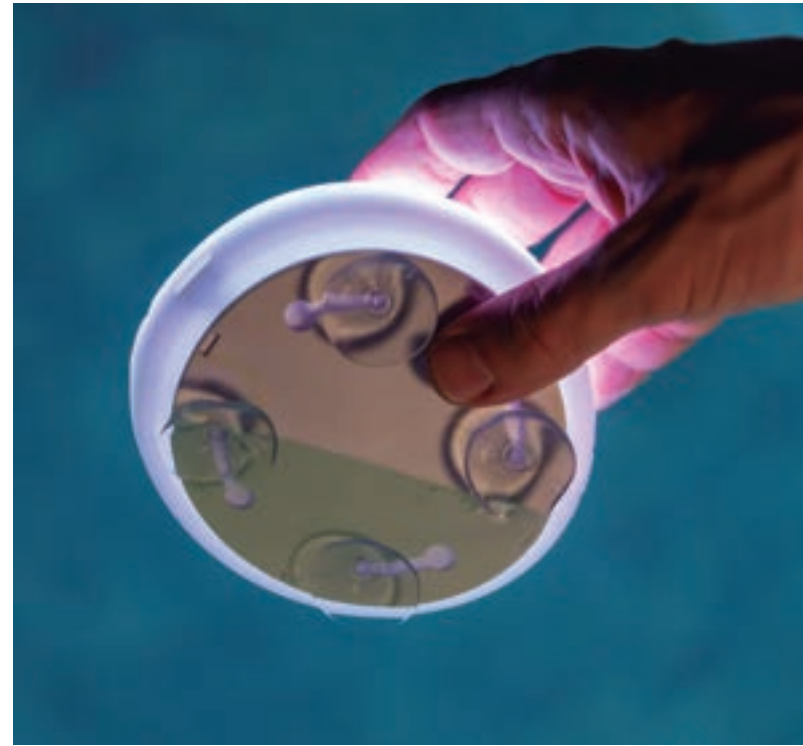

Papaya 30.

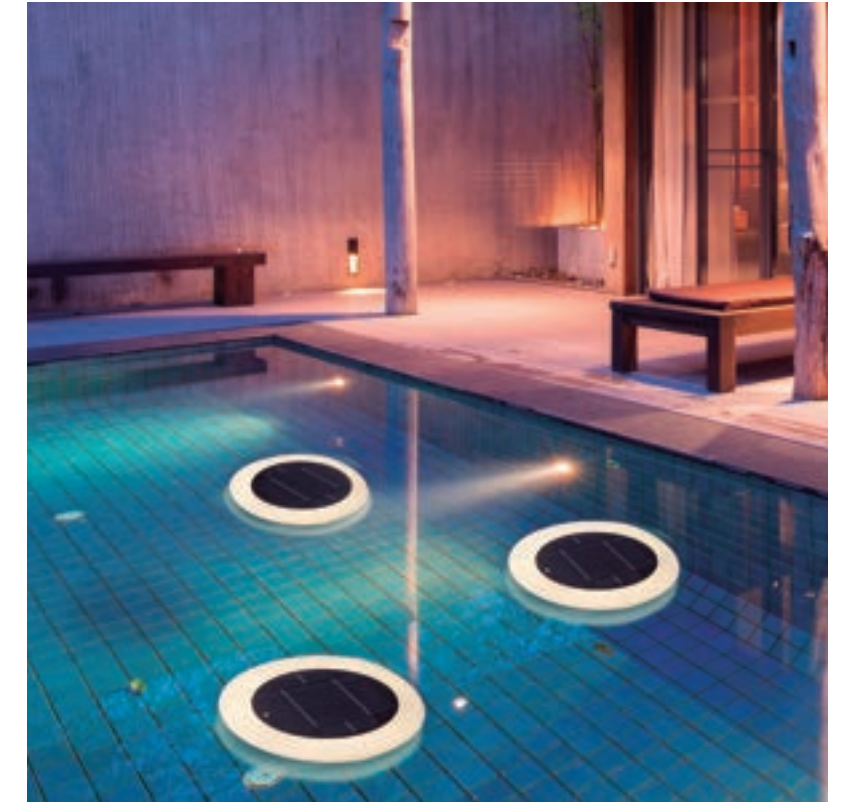

PAPAYA 12

MAGNETIC RECHARGEABLE BATTERY

- Outdoor use
- Magnetic rechargeable battery
- Warm Light (included)
- White Light (included)
- RGB Light (included)
- 800 lm

REF: LUMPPY012XXWLNW

- Remote control (included)
- Dimmable
- Floating & submersible
- Polycarbonate
- Packaging: 12,5 x 12,5 x 5,3 cm
- Gross Weight (with packaging): 0,6kg

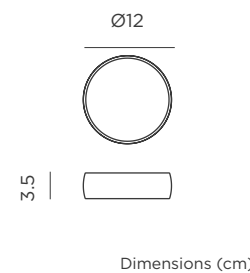

PAPAYA 30

SOLAR & MAGNETIC RECHARGEABLE BATTERY

- Outdoor use
- Solar + Magnetic rechargeable battery
- Warm Light (included)
- White Light (included)
- RGB Light (included)
- 800 lm
- Remote control (included)

REF: LUMPPY030XXSLNW

- Dimmable
- Floating & submersible
- Solar panel included
- Polycarbonate
- Packaging: 29,5 x 4,3 x 29,5 cm
- Gross Weight (with packaging): 1,16kg

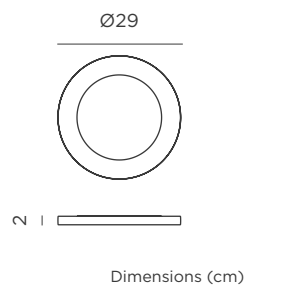

Buly Floating.



BULY 20/30/40 | FLOATING

SOLAR

- IP68 Outdoor use
- Solar Charge
- Warm Light (included)
- White Light (included)
- RGB Light (included)
- 45 lm
- Remote control (included)
- Dimmable
- Twilight sensor
- Floating, not submersible
- M Polyethylene

Buly 20

REF: LUMBLO20FTNW

- Packaging: 20,3 x 20,3 x 19,5 cm
- Gross Weight (with packaging): 0,8kg

Buly 30

REF: LUMBLO30FTNW

- Packaging: 31,5 x 31,5 x 29 cm
- Gross Weight (with packaging): 1,2kg

Buly 40

REF: LUMBLO40FTNW

- Packaging: 36,6 x 40,3 x 40,3 cm
- Gross Weight (with packaging): 1,9kg

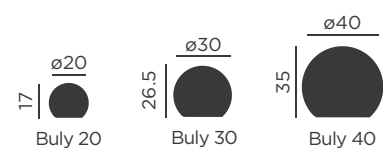

Dimensions (cm)

BULY 20

SOLAR

- IP68 Outdoor use
- Solar Charge
- White Light (included)
- 16 lm
- Twilight sensor

REF: LUMBLO20SANW

- Floating, not submersible
- M Polyethylene
- Packaging: 20,3 x 20,3 x 19,5 cm
- Gross Weight (with packaging): 0,8kg



Dimensions (cm)

Play Disk 40.



PLAY DISK 40

RECHARGEABLE BATTERY

- IP67 Outdoor & Indoor use
- Rechargeable Battery Electric Charge (driver not included)
- RGB Light (included)
- 900 lm
- Remote control (included)
- Dimmable

REF: LUMPDK040XXPLNW

- Play Music
- Floating, not submersible
- M Polyethylene
- Packaging: 39,5 x 6,5 x 39,5 cm
- Gross Weight (with packaging): 2,65kg
- Up to two Play Disk can be connected

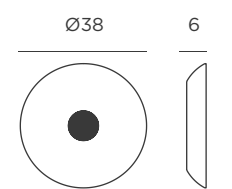

Dimensions (cm)



COCO | FLOATING PORTABLE LIGHT BULB | + INFO PAG 136.

Indoor &
Christmas



INDOOR COLLECTION

+ Ask us and discover our complete Indoor Collection.

PRODUCTS

(1) ROLL & BOX COLLECTION | INFO PAG 140
(5) LOLA SLIM 30

(2) AMALFI 80 HANG INDOOR
(6) SAONA HANG INDOOR

(3) SAONA INDOOR
(7) LOLA SLIM 180

(4) BULY 30 INDOOR
(8) SISINE 70 INDOOR

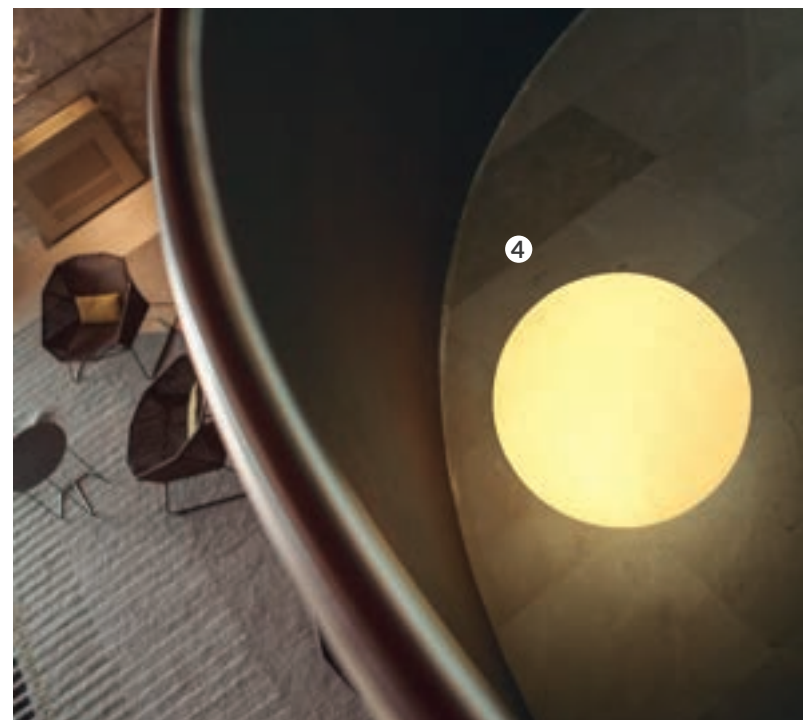
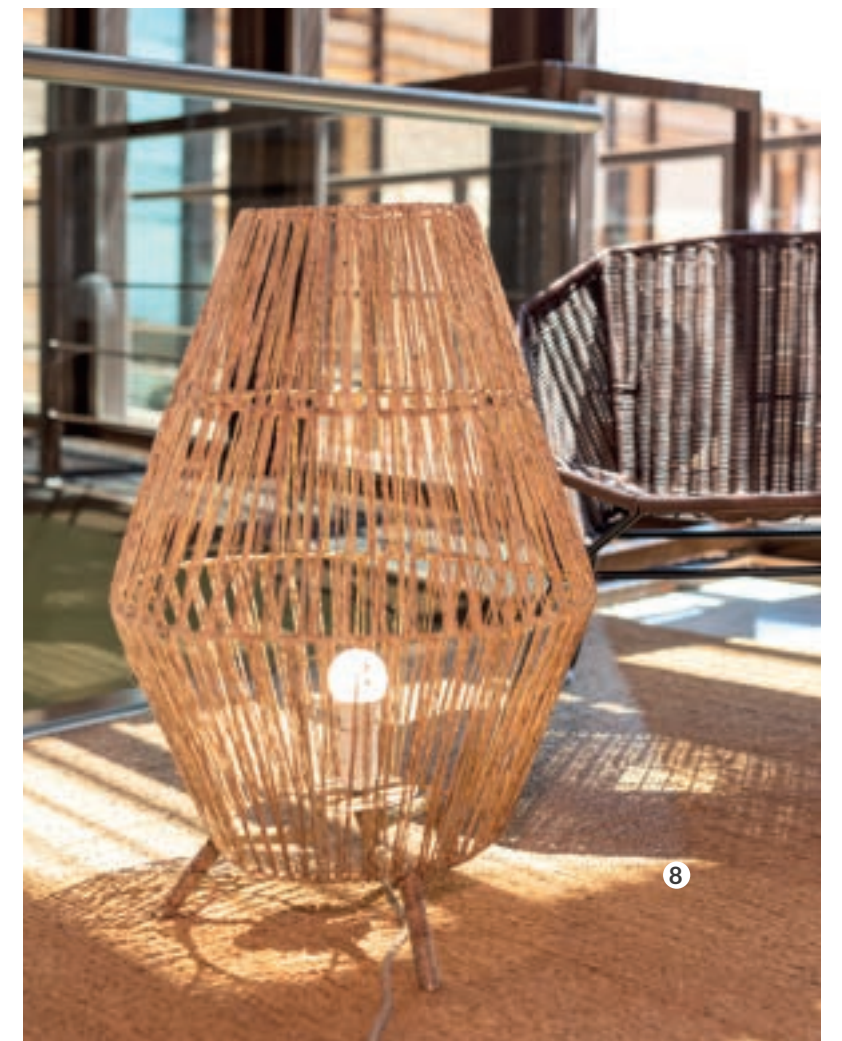
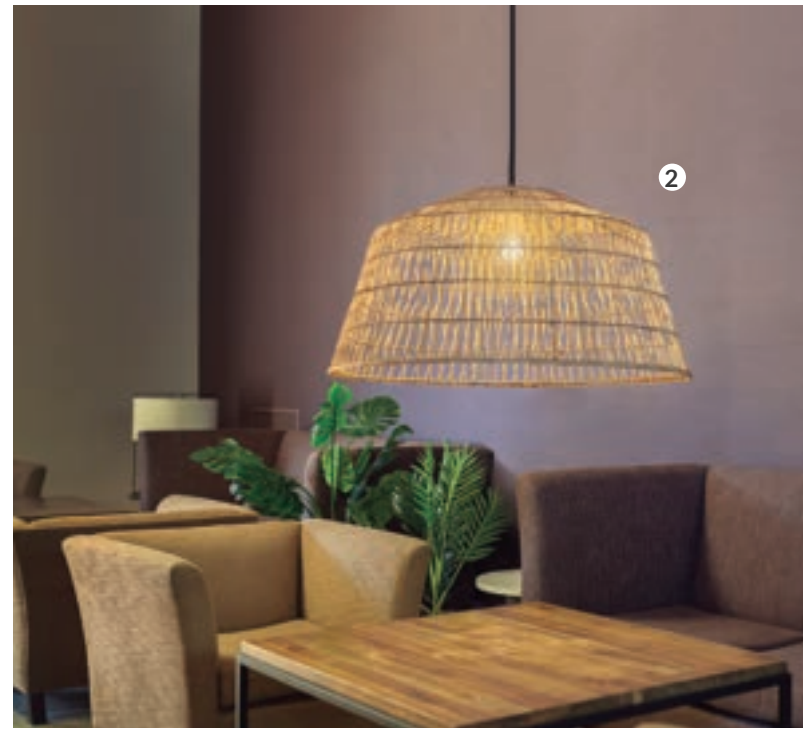

CHRISTMAS COLLECTION

+ Ask us and discover our complete Christmas Collection.

PRODUCTS

(1) PALLINA GARLAND (2) BIANCA GARLAND (3) LUA (4) GIFTY COLLECTION (5) SISINE STAR 60 (6) PINUS COLLECTION

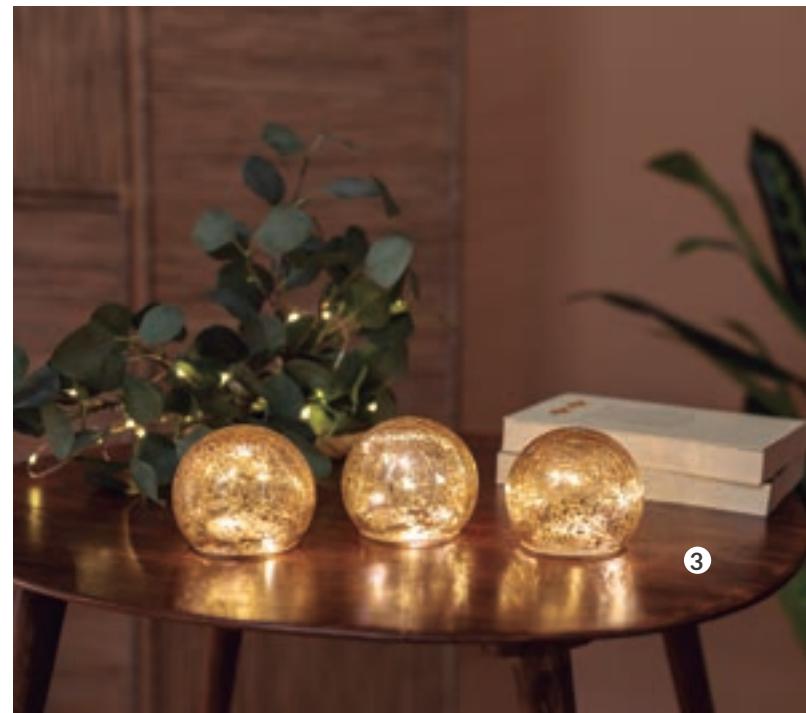
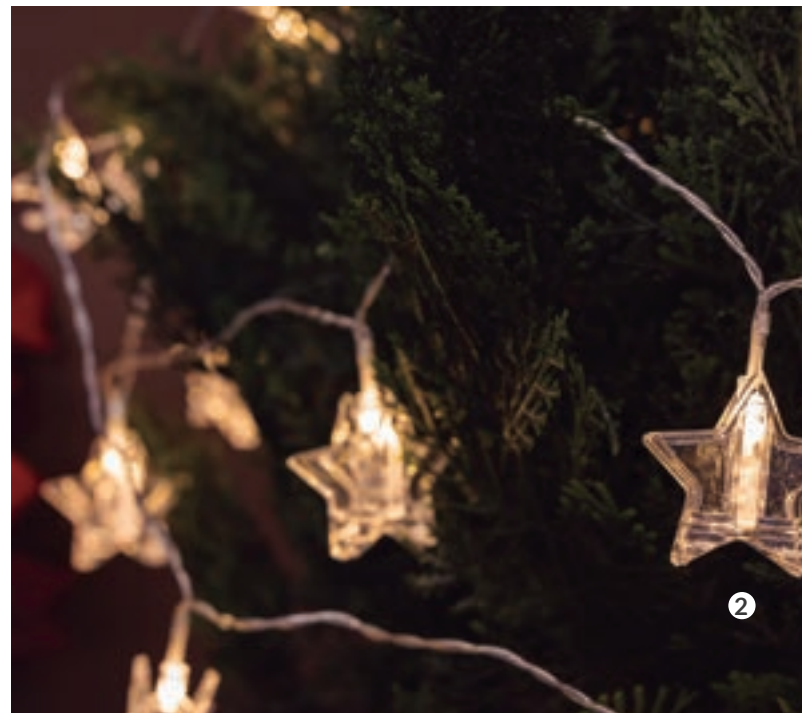



furniture

Paradise MODE ON

PRODUCTS

(1) HIAMA
(5) HORTENSIA 30

(2) AURORA GARLAND
(6) CHLOE 140

(3) NIZA 165
(7) RASA

(4) TARIDA TAB
(8) SIROCO





Rasa.





RASA | WHITE OPAQUE COLOUR

White |  REF: MOBRASABXNW

- M** Polyethylene
-  Packaging: 81,5 x 205 x 36 cm
-  Gross Weight (with packaging): 22kg

RASA | CIRCOOLAR



Recycled Multicolour |  REF: MOBRAS200BXNLCR

- M** Recycled detergent bottles
-  Packaging: 81,5 x 205 x 36 cm
-  Gross Weight (with packaging): 22kg

  Made of recycled detergent bottles

RASA | CIRCOOLAR

Recycled Blue |  REF: MOBRAS200AZNLCR

- M** Recycled fishing nets
-  Packaging: 81,5 x 205 x 36 cm
-  Gross Weight (with packaging): 22kg

  Made of recycled fishing nets

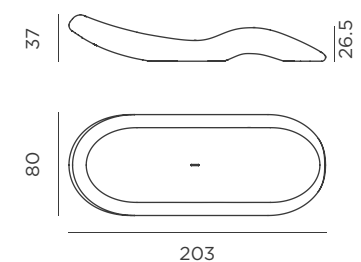

Dimensions (cm)



Formentera.















Formentera.

FORMENTERA

SOLAR & RECHARGEABLE BATTERY



REF: MOBFR160SSNW



-  Outdoor & Indoor use
-  Solar + Rechargeable Battery (driver not included)
-  Warm Light (included)
-  White Light (included)
-  RGB Light (included)
-  45X4 lm (Lumens per bulb)
-  Remote control (included)

-  Dimmable
-  Twilight sensor
-  Integrated solar panel
-  Polyethylene
-  Packaging: Plastic bag
-  Gross Weight (with packaging): 41kg

CABLE

REF: MOBFR160OFNW



-  Outdoor & Indoor use
-  White Light (included)
-  600 lm

-  Polyethylene
-  Packaging: Plastic bag
-  Gross Weight (with packaging): 41kg

WHITE OPAQUE COLOUR

REF: MOBFR160BXNW

-  Polyethylene

-  Packaging: Plastic bag
-  Gross Weight (with packaging): 41kg

White Formentera mattress | 140 x 112 x 8 cm

REF: MOBCNF140BXNLNW

White Formentera pillow | 50 x 50 cm

REF: MOBCNC050BXNLNW

White Formentera pillow | 60 x 60 cm

REF: MOBCNR060BXNLNW

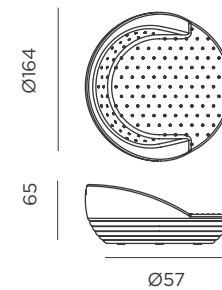

Ø57

Dimensions (cm)

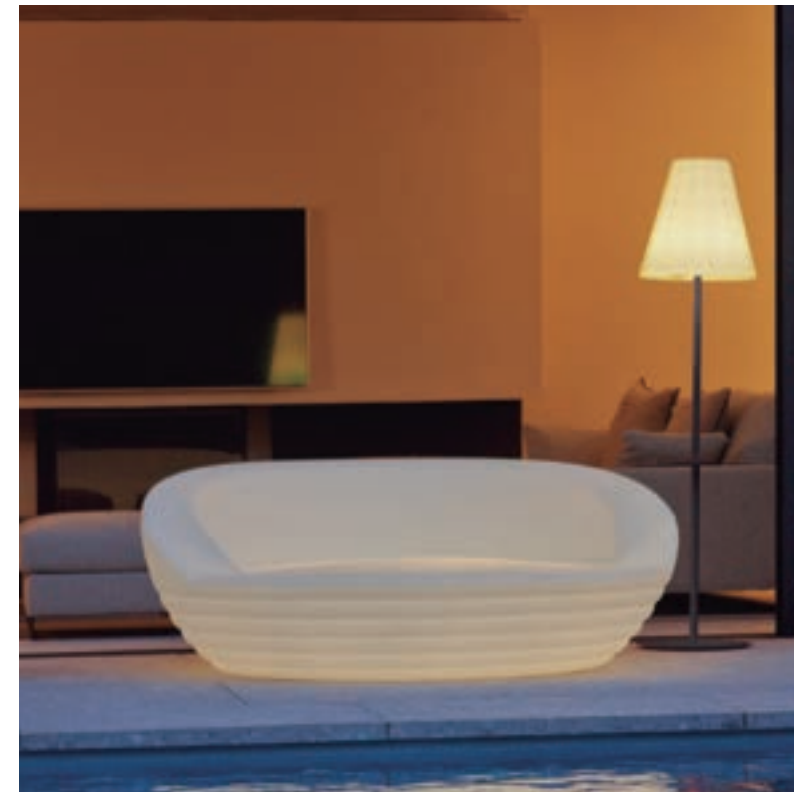

New Island.

MARTINICA TAB

SOLAR & RECHARGEABLE BATTERY

REF: MOBMESSASSNW

- IP65 Outdoor & Indoor use
- Solar + Rechargeable Battery (driver not included)
- Warm Light (included)
- White Light (included)
- RGB Light (included)
- Im 45 lm
- Remote control (included)

- Dimmable
- Twilight sensor
- Integrated solar panel
- M** Polyethylene
- Packaging: 101 x 101 x 36 cm
- Gross Weight (with packaging): 10kg

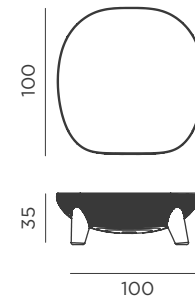

Dimensions (cm)



ARUBA SIT

SOLAR & RECHARGEABLE BATTERY

REF: MOBSILARSSNW

- IP65 Outdoor & Indoor use
- Solar + Rechargeable Battery (driver not included)
- Warm Light (included)
- White Light (included)
- RGB Light (included)
- Im 45 lm
- Remote control (included)

- Dimmable
- Twilight sensor
- Integrated solar panel
- M** Polyethylene
- Packaging: 81,5 x 81 x 82,5 cm
- Gross Weight (with packaging): 15,5kg

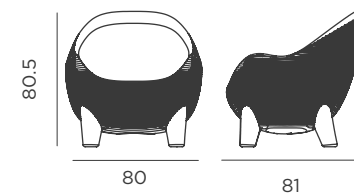

Dimensions (cm)



WHITE OPAQUE COLOUR

REF: MOBSILARBXNW

M Polyethylene

- Packaging: 81,5 x 81 x 82,5 cm
- Gross Weight (with packaging): 11,5kg

JAMAICA SOFA

SOLAR & RECHARGEABLE BATTERY

REF: MOBSCJASSNW

- IP65 Outdoor & Indoor use
- Solar + Rechargeable Battery (driver not included)
- Warm Light (included)
- White Light (included)
- RGB Light (included)
- Im 45x2 lm (lumens per bulb)
- Remote control (included)

- Dimmable
- Twilight sensor
- Integrated solar panel
- M** Polyethylene
- Packaging: 210 x 81,5 x 80,5 cm
- Gross Weight (with packaging): 30,5kg

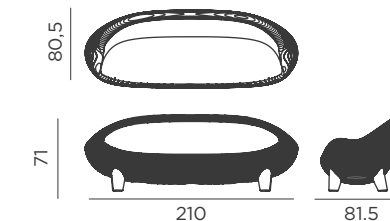

Dimensions (cm)

CABLE

REF: MOBSC120OFNW

- IP65 Outdoor & Indoor use
- White Light (included)
- Im 600 lm

- M** Polyethylene
- Packaging: Plastic bag
- Gross Weight (with packaging): 30,5kg

WHITE OPAQUE COLOUR

REF: MOBSC120BXNW

M Polyethylene

- Packaging: Plastic bag
- Gross Weight (with packaging): 30,5kg



MADE OF RECYCLED
MATERIALS

Furniture | Sets | Tarida

Tarida Set.

CIRCOOLAR



Tarida Set.

TARIDA TAB

SOLAR & RECHARGEABLE BATTERY

REF: MOBTD30SSNW

- IP65 Outdoor & Indoor use
- Solar + Rechargeable Battery (driver not included)
- Warm Light (included)
- White Light (included)
- RGB Light (included)
- 45 lm
- Remote control (included)

- Dimmable
- Twilight sensor
- Integrated solar panel
- Polyethylene | Methacrylate cover
- Packaging: 45,6 x 59,6 x 31,5 cm
- Gross Weight (with packaging): 6kg

RECHARGEABLE BATTERY

REF: MOBTD30PLNW

- IP43 Outdoor & Indoor use
- Rechargeable Battery Electric Charge (driver not included)
- White Light (included)
- RGB Light (included)
- 45 lm
- Remote control (included)

- Dimmable
- Play music
- x2 Speakers
- Polyethylene | Methacrylate cover
- Packaging: 45,6 x 59,6 x 31,5 cm
- Gross Weight (with packaging): 6,8kg

WHITE OPAQUE COLOUR

White | REF: MOBTD30BXNW

- Polyethylene | Methacrylate cover
- Packaging: 45,6 x 59,6 x 31,5 cm
- Gross Weight (with packaging): 4,5kg

TARIDA TAB | CIRCOOLAR

Recycled Multicolour | REF: MOBTD30BXNLCR

- Recycled detergent bottles
- Packaging: 45,6 x 59,6 x 31,5 cm
- Gross Weight (with packaging): 4,5kg

Made of recycled detergent bottles

TARIDA TAB | CIRCOOLAR

Recycled Blue | REF: MOBTD30AZNLCR

- Recycled fishing nets
- Packaging: 45,6 x 59,6 x 31,5 cm
- Gross Weight (with packaging): 4,5kg

Made of recycled fishing nets

TARIDA SIT

SOLAR & RECHARGEABLE BATTERY

White | REF: MOBTD566SSNW

- IP65 Outdoor & Indoor use
- Solar + Rechargeable Battery (driver not included)
- Warm Light (included)
- White Light (included)
- RGB Light (included)
- 600 lm
- Remote control (included)

- Dimmable
- Twilight sensor
- Integrated solar panel
- Polyethylene
- Packaging: 69 x 77 x 66,5 cm
- Gross Weight (with packaging): 8,5kg

TARIDA SIT | CIRCOOLAR

Recycled Multicolour | REF: MOBTD566BXNLCR

- Recycled detergent bottles
- Packaging: 69 x 77 x 66,5 cm
- Gross Weight (with packaging): 8,5kg

Made of recycled detergent bottles

TARIDA SIT | CIRCOOLAR

Recycled Blue | REF: MOBTD566AZNLCR

- Recycled fishing nets
- Packaging: 69 x 77 x 66,5 cm
- Gross Weight (with packaging): 8,5kg

Made of recycled fishing nets

Pillow included

TARIDA SIT ARMS

SOLAR & RECHARGEABLE BATTERY

REF: MOBTD566ARMSSNW

- IP65 Outdoor & Indoor use
- Solar + Rechargeable Battery (driver not included)
- Warm Light (included)
- White Light (included)
- RGB Light (included)
- 600 lm
- Remote control (included)

- Dimmable
- Twilight sensor
- Integrated solar panel
- Polyethylene | Steel arms (wood effect)
- Packaging: 69 x 77 x 66,5 cm
- Gross Weight (with packaging): 12kg

WHITE OPAQUE COLOUR

REF: MOBTD566ARMBXNW

- 80% PVC, 18% PES, 2% PU | Steel arms

- Packaging: 69 x 77 x 66,5 cm
- Gross Weight (with packaging): 12kg

Pillow included

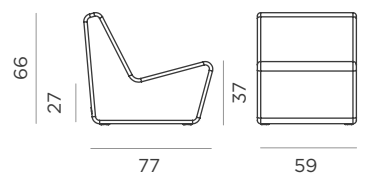
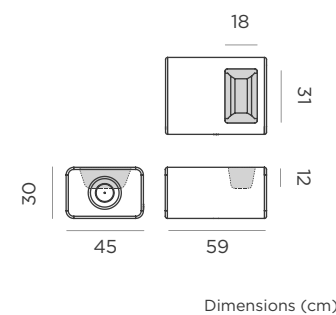

Dimensions (cm)

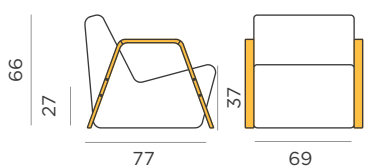

Dimensions (cm)

Tafy & Cuby.



CUBY 53 | CIRCOOLAR

Recycled Multicolour | REF: MOBCBY053BXNLCR

- M Recycled detergent bottles
- ☞ Packaging: 40,5 x 40,5 x 40 cm
- 📦 Gross Weight (with packaging): 2,9kg

♻️ Made of recycled detergent bottles

CUBY 53 | CIRCOOLAR

Recycled Blue | REF: MOBCBY053AZNLCR

- M Recycled fishing nets
- ☞ Packaging: 40,5 x 40,5 x 40 cm
- 📦 Gross Weight (with packaging): 2,9kg

♻️ Made of recycled fishing nets

CUBY 53

See other Cubes on pag. 164

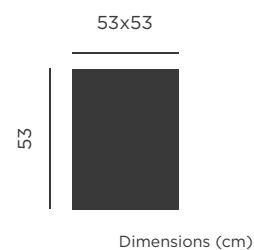

Tafy & Pufy.



TAFY 38

- M Polyethylene
- ☞ Packaging: 40,5 x 40,5 x 40 cm
- 📦 Gross Weight (with packaging): 2,9kg

White | ○ REF: MOBTF038BXNW
Black | ● REF: MOBTF038NXNW

TAFY | CIRCOOLAR

Recycled Multicolour | REF: MOBTFY038BXNLCR

- M Recycled detergent bottles
- ☞ Packaging: 40,5 x 40,5 x 40 cm
- 📦 Gross Weight (with packaging): 2,9kg

♻️ Made of recycled detergent bottles

TAFY | CIRCOOLAR

Recycled Blue | REF: MOBTFY038AZNLCR

- M Recycled fishing nets
- ☞ Packaging: 40,5 x 40,5 x 40 cm
- 📦 Gross Weight (with packaging): 2,9kg

♻️ Made of recycled fishing nets

PUFY 45

- M Polyethylene

White | ○ REF: MOBPF045BXNW
☞ Packaging: 45 x 43,5 x 43,5 cm
📦 Gross Weight (with packaging): 4kg

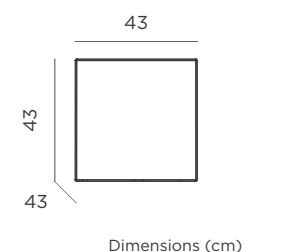
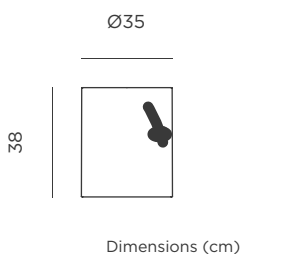

Capri 40 & Corfu 40.

CAPRI 40 TAB

SOLAR & RECHARGEABLE BATTERY

REF: MOBCP040SSNW

- IP65 Outdoor & Indoor use
- Solar + Rechargeable Battery (driver not included)
- Warm Light (included)
- White Light (included)
- RGB Light (included)
- 45 lm
- Remote control (included)

- Dimmable
- Twilight sensor
- Integrated solar panel
- Polyethylene | Methacrylate cover
- Packaging: 60 x 60 x 42 cm
- Gross Weight (with packaging): 4,5kg

WHITE OPAQUE COLOUR

REF: MOBCP040BXNW

Polyethylene & Methacrylate cover

- Packaging: 60 x 60 x 42 cm
- Gross Weight (with packaging): 4kg

CORFU 40 SIT

SOLAR & RECHARGEABLE BATTERY

REF: MOBCF040SSNW

- IP65 Outdoor & Indoor use
- Solar + Rechargeable Battery (driver not included)
- Warm Light (included)
- White Light (included)
- RGB Light (included)
- 45 lm
- Remote control (included)

- Dimmable
- Twilight sensor
- Integrated solar panel
- Polyethylene
- Packaging: 40,5 x 40,5 x 40 cm
- Gross Weight (with packaging): 3,5kg

WHITE OPAQUE COLOUR

REF: MOBCF040BXNW

- Polyethylene
- Packaging: 40,5 x 40,5 x 40 cm
- Gross Weight (with packaging): 3kg



Ø58



Ø36

39

Dimensions (cm)

Ø40

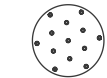

Ø33

38

Dimensions (cm)



Capri 75 & Mallorca.

CAPRI 75 TAB

SOLAR & RECHARGEABLE BATTERY

REF: MOBPC075SSNW

- IP65 Outdoor & Indoor use
- Solar + Rechargeable Battery (driver not included)
- Warm Light (included)
- White Light (included)
- RGB Light (included)
- 45 lm
- Remote control (included)

- Dimmable
- Twilight sensor
- Integrated solar panel
- Polyethylene | Methacrylate cover
- Packaging: 102 x 100 x 74,4 cm
- Gross Weight (with packaging): 18kg

WHITE OPAQUE COLOUR

REF: MOBPC075BXNW

Polyethylene | Methacrylate cover

- Packaging: 102 x 100 x 74,4 cm
- Gross Weight (with packaging): 18kg

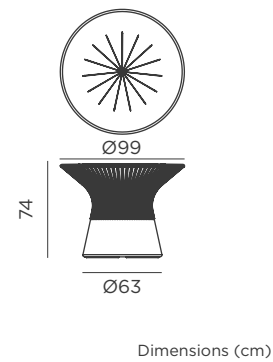

MALLORCA SIT

SOLAR & RECHARGEABLE BATTERY

REF: MOBMA060SSNW

- IP65 Outdoor & Indoor use
- Rechargeable Battery Electric Charge (driver not included)
- Warm Light (included)
- White Light (included)
- RGB Light (included)
- 45 lm
- Remote control (included)

- Dimmable
- Twilight sensor
- Integrated solar panel
- Polyethylene
- Packaging: 60 x 60 x 73 cm
- Gross Weight (with packaging): 7,5kg

WHITE OPAQUE COLOUR

REF: MOBMA060BXNW

Polyethylene

- Packaging: 60 x 60 x 73 cm
- Gross Weight (with packaging): 7kg

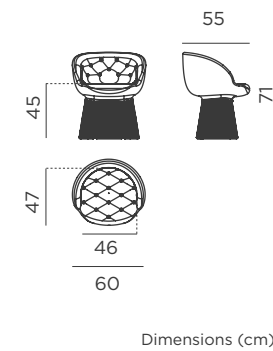

Capri 110 & Corfu 74.

CAPRI 110 TAB

🔌 RECHARGEABLE BATTERY

REF: MOBCP110TWLNW

- 🏠 IP65 Outdoor & Indoor use
- 🔌 Rechargeable Battery Electric Charge (driver not included)
- 💡 White Light (included)
- 🌈 RGB Light (included)
- 💡 110 lm
- 📱 Remote control (included)

- 📏 Dimmable
- 💡 Led tube lighting (included)
- 📦 Polyethylene | Methacrylate cover
- 📦 Packaging: 60 x 60 x 113 cm
- 📦 Gross Weight (with packaging): 10kg

○ WHITE OPAQUE COLOUR

REF: MOBCP110BXNW

- 📦 Polyethylene | Methacrylate cover

- 📦 Packaging: 60 x 60 x 113 cm
- 📦 Gross Weight (with packaging): 8,5kg

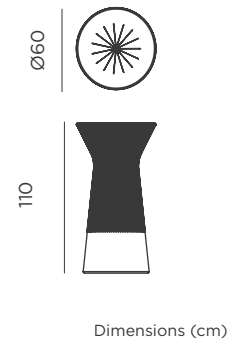

CORFU 74 SIT

🔌 + ☀️ SOLAR & RECHARGEABLE BATTERY

REF: MOBCF074SSNW

- 🏠 IP65 Outdoor & Indoor use
- 🔌 Rechargeable Battery Electric Charge (driver not included)
- 💡 Warm Light (included)
- 💡 White Light (included)
- 🌈 RGB Light (included)
- 💡 45 lm
- 📱 Remote control (included)

- 📏 Dimmable
- 🌙 Twilight sensor
- ☀️ Integrated solar panel
- 📦 Polyethylene
- 📦 Packaging: 40 x 40 x 74,8 cm
- 📦 Gross Weight (with packaging): 5,5kg

○ WHITE OPAQUE COLOUR

REF: MOBCF074BXNW

- 📦 Polyethylene

- 📦 Packaging: 40 x 40 x 74,8cm
- 📦 Gross Weight (with packaging): 5kg

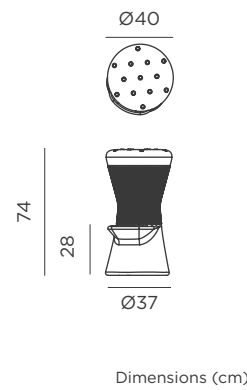













Itaca & Mallorca.

ITACA 60 TAB

 SOLAR & RECHARGEABLE BATTERY

REF: MOBITC60SSNW

-  Outdoor & Indoor use
-  Rechargeable Battery Electric Charge (driver not included)
-  Warm Light (included)
-  White Light (included)
-  RGB Light (included)
-  45 lm
-  Remote control (included)



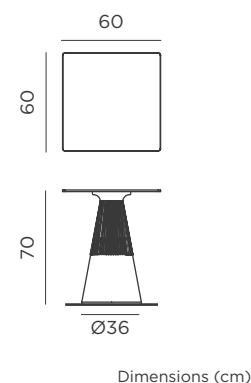



-  Dimmable
-  Twilight sensor
-  Integrated solar panel
-  Polyethylene | White phenolic cover
-  Packaging: 36,5 x 36,5 x 71,5 cm
-  Gross Weight (with packaging): 12,6kg









MALLORCA SIT

 SOLAR & RECHARGEABLE BATTERY

REF: MOBMA060SSNW

-  Outdoor & Indoor use
-  Rechargeable Battery Electric Charge (driver not included)
-  Warm Light (included)
-  White Light (included)
-  RGB Light (included)
-  45 lm
-  Remote control (included)

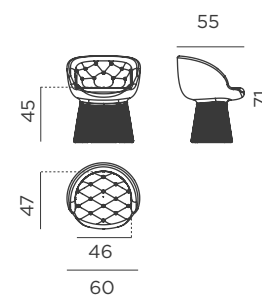

-  Dimmable
-  Twilight sensor
-  Integrated solar panel
-  Polyethylene
-  Packaging: 60 x 60 x 73 cm
-  Gross Weight (with packaging): 7,5kg



WHITE OPAQUE COLOUR

REF: MOBMA060BXNW

 Polyethylene

-  Packaging: 60 x 60 x 73 cm
-  Gross Weight (with packaging): 7kg









BORA WOOD

BORA

 **JUTE CABLE**

-  Outdoor & Indoor use
-  Warm Light (included)
-  White Light (included)
-  860 lm
-  Remote control (included)
-  Dimmable

- Marble | **REF: LUMBORAMBXINOUTNW**
 - M** Ceramic | Polyethylene
 -  Packaging: 44 x 44 x 47 cm
 -  Gross Weight (with packaging): 8,2kg
- Wood | **REF: LUMBORAWBXINOUTNW**
 - M** Bamboo | Polyethylene
 -  Packaging: 44 x 44 x 45,5cm
 -  Gross Weight (with packaging): 6,54kg

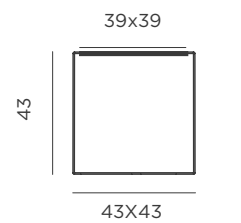

Dimensions (cm)

Bora.

BORA MARBLE











Sicilia 75.

SICILIA 75

 **SOLAR & RECHARGEABLE BATTERY**

REF: MOBSC075SSNW

-  Outdoor & Indoor use
-  Solar + Rechargeable Battery (driver not included)
-  Warm Light (included)
-  White Light (included)
-  RGB Light (included)
-  45 lm
-  Remote control (included)

-  Dimmable
-  Twilight sensor
-  Integrated solar panel
-  Polyethylene | Methacrylate cover
-  Packaging: 75 x 76,5 x 118,5 cm
-  Gross Weight (with packaging): 33kg

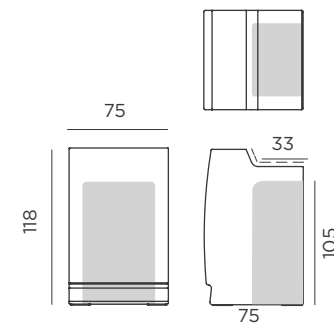

Dimensions (cm)















Sicilia 120.

SICILIA 120

 **SOLAR & RECHARGEABLE BATTERY**

REF: MOBSC120SSNW

-  Outdoor & Indoor use
-  Solar + Rechargeable Battery (driver not included)
-  Warm Light (included)
-  White Light (included)
-  RGB Light (included)
-  45 lm
-  Remote control (included)



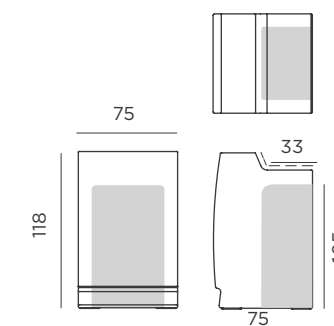

-  Dimmable
-  Twilight sensor
-  Integrated solar panel
-  Polyethylene | Methacrylate cover
-  Packaging: 120 x 76,5 x 118,5 cm
-  Gross Weight (with packaging): 40kg





Dimensions (cm)

 **CABLE**

REF: MOBSC120OFNW



-  Outdoor & Indoor use
-  White Light (included)
-  2800 lm
-  Led tube lighting (included)

-  Polyethylene | Methacrylate cover
-  Packaging: 120 x 76,5 x 118,5 cm
-  Gross Weight (with packaging): 40kg

 **WHITE OPAQUE COLOUR**

REF: MOBSC120BXNW

-  Polyethylene | Methacrylate cover

-  Packaging: 120 x 76,5 x 118,5 cm
-  Gross Weight (with packaging): 40kg









Ibiza 120.





IBIZA 120

SOLAR & RECHARGEABLE BATTERY

REF: MOBBZ120SSNW



-  Outdoor & Indoor use
-  Solar + Rechargeable Battery (driver not included)
-  Warm Light (included)
-  White Light (included)
-  RGB Light (included)
-  45 lm
-  Remote control (included)

-  Dimmable
-  Twilight sensor
-  Integrated solar panel
-  Polyethylene | Methacrylate cover
-  Packaging: 80 x 120 x 113 cm
-  Gross Weight (with packaging): 23,8kg

CABLE

REF: MOBBZ120OFNW

-  Outdoor & Indoor use
-  White Light (included)
-  600 lm

-  Polyethylene | Methacrylate cover
-  Packaging: 80 x 120 x 113 cm
-  Gross Weight (with packaging): 23,8kg

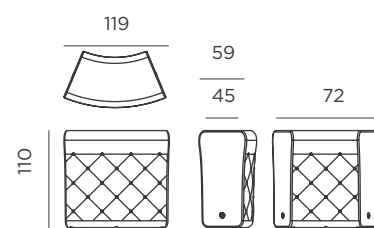

Dimensions (cm)

Creta 120.



CRETA 120

SOLAR & RECHARGEABLE BATTERY

REF: MOBCR120SSNW

- IP65 Outdoor & Indoor use
- Rechargeable Battery Electric Charge (driver not included)
- Warm Light (included)
- White Light (included)
- RGB Light (included)
- 45 lm
- Remote control (included)

- Dimmable
- Twilight sensor
- Integrated solar panel
- Polyethylene | Methacrylate cover
- Packaging: 120 x 66 x 111,5 cm
- Gross Weight (with packaging): 27kg

CABLE

REF: MOBCR120OFNW

- IP65 Outdoor & Indoor use
- White Light (included)
- 600 lm

- Polyethylene | Methacrylate cover
- Packaging: 120 x 66 x 111,5 cm
- Gross Weight (with packaging): 27kg

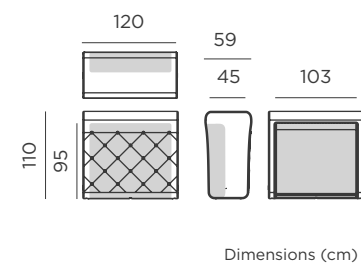

Shelf accessory | 21 x 101 x 1 cm

REF: MOBCRE101BXNLNW

Palma Bottle.



PALMA BOTTLE RACK

SOLAR & RECHARGEABLE BATTERY

REF: LUMPMB70SSNW

- Outdoor & Indoor use
- Solar + Rechargeable Battery (driver not included)
- Warm Light (included)
- White Light (included)
- RGB Light (included)
- 45 lm
- Remote control (included)

- Dimmable
- Twilight sensor
- Integrated solar panel
- Polyethylene
- Packaging: 35,5 x 35,5 x 70 cm
- Gross Weight (with packaging): 2,42kg

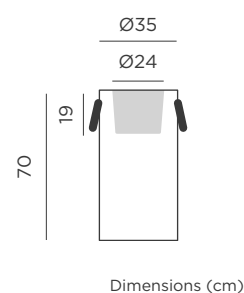

COOLER ACESORY

BAMBU COOLER

REF: LUMCLB035XXNLNW

Outdoor & Indoor use

- Aluminium
- Packaging: 35 x 18 x 35 cm
- Gross Weight (with packaging): 5kg

PALMA COOLER

REF: LUMCLP035XXNLNW

Outdoor & Indoor use

- Aluminium
- Packaging: 35 x 18 x 35 cm
- Gross Weight (with packaging): 2,42kg

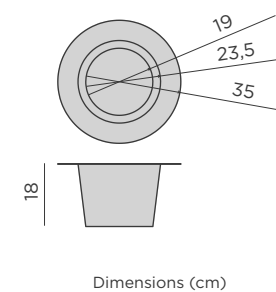

Woody.



WOODY

SOLAR & RECHARGEABLE BATTERY

REF: LUMWD070SSNW

- Outdoor & Indoor use
- Solar + Rechargeable Battery (driver not included)
- Warm Light (included)
- White Light (included)
- RGB Light (included)
- 45 lm
- Remote control (included)

- Dimmable
- Twilight sensor
- Integrated solar panel
- Cooler accessory included
- Polyurethane | Synthetic leather handle
- Packaging: 40,5 x 40,5 x 70 cm
- Gross Weight (with packaging): 5kg

WOODY PLAY

RECHARGEABLE BATTERY

REF: LUMWD070PLNW

- Outdoor & Indoor use
- Rechargeable Battery Electric Charge (driver not included)
- White Light (included)
- RGB Light (included)
- 45 lm
- Remote control (included)

- Dimmable
- Play music
- x1 Speaker
- Cooler accessory included
- Polyurethane | Synthetic leather handle
- Packaging: 40,5 x 40,5 x 70 cm
- Gross Weight (with packaging): 5,2kg

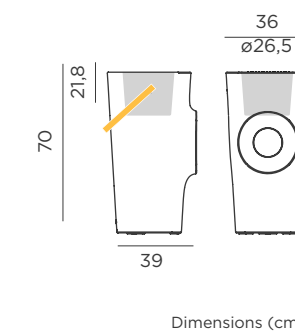

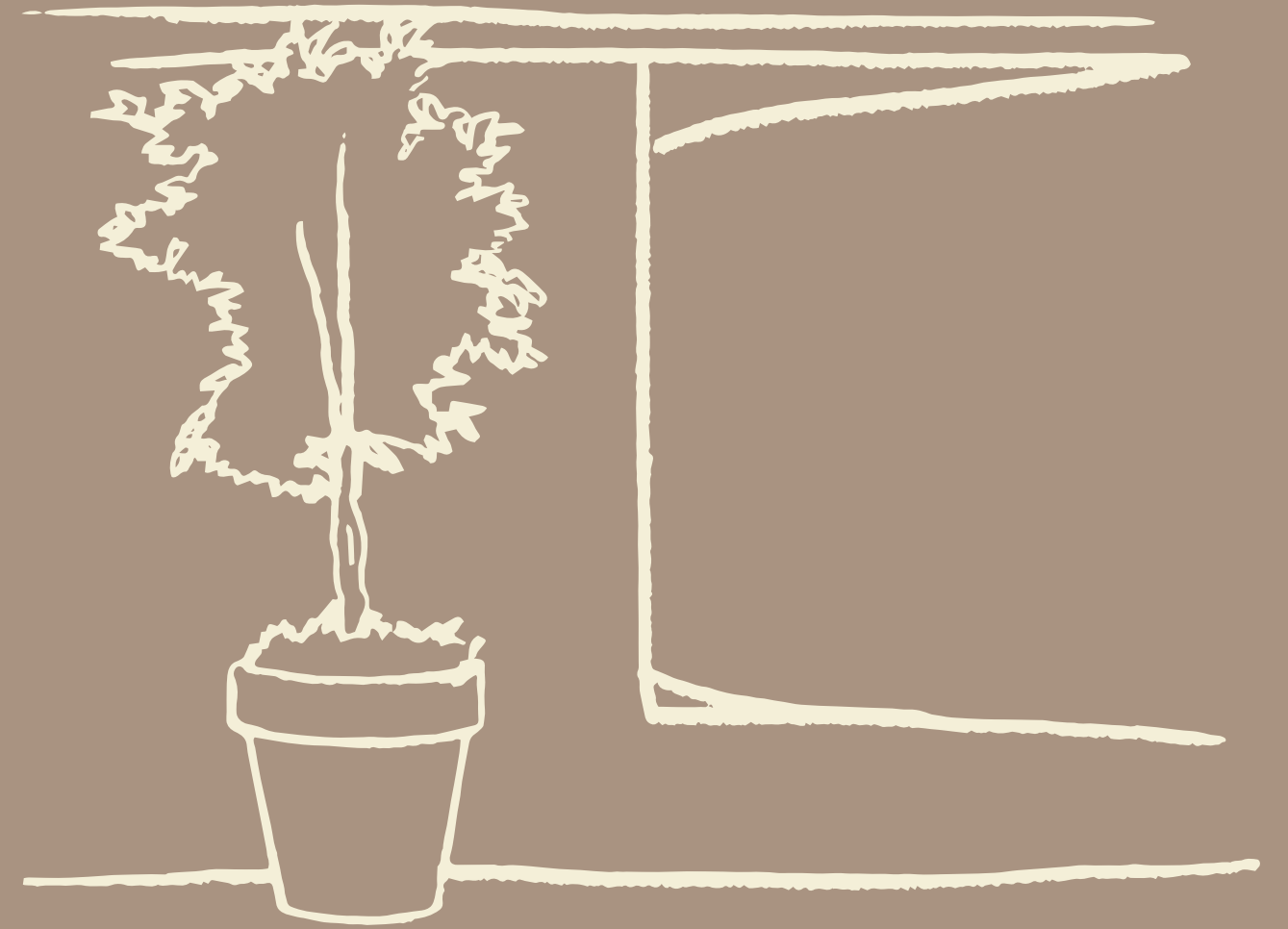

Flowerpots

Azalea Collection.

AZALEA 30

- 9,4 L
- Includes water reservoir
- M Polyethylene
- Packaging: Plastic bag
- Gross Weight (with packaging): 1kg

- White | ○ REF: **JDNAZA030BXNLNW**
- Black | ● REF: **JDNAZA030NXNLNW**
- Bronze | ● REF: **JDNAZA030ZXNLNW**
- Terracota | ● REF: **JDNAZA030TXNLNW**
- Anthracite | ● REF: **JDNAZA030ANLNLNW**

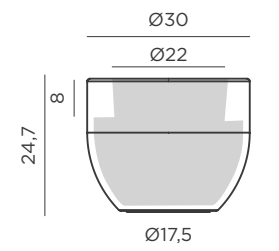

Dimensions (cm)

AZALEA 40

- 19,7 L
- Includes water reservoir
- M Polyethylene
- Packaging: Plastic bag
- Gross Weight (with packaging): 2kg

- White | ○ REF: **JDNAZA040BXNLNW**
- Black | ● REF: **JDNAZA040NXNLNW**
- Bronze | ● REF: **JDNAZA040ZXNLNW**
- Terracota | ● REF: **JDNAZA040TXNLNW**
- Anthracite | ● REF: **JDNAZA040ANLNLNW**

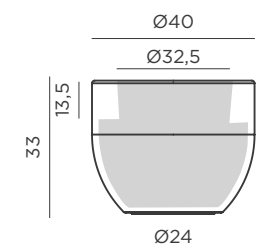

Dimensions (cm)

AZALEA 50

- 37,8 L
- Includes water reservoir
- M Polyethylene
- Packaging: Plastic bag
- Gross Weight (with packaging): 3,5kg

- White | ○ REF: **JDNAZA050BXNLNW**
- Black | ● REF: **JDNAZA050NXNLNW**
- Bronze | ● REF: **JDNAZA050ZXNLNW**
- Terracota | ● REF: **JDNAZA050TXNLNW**
- Anthracite | ● REF: **JDNAZA050ANLNLNW**

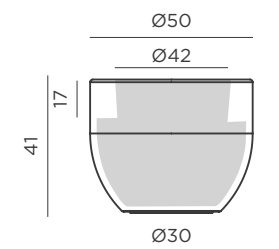

Dimensions (cm)



HORTENSIA 30

- 17,8 L
- Includes water reservoir
- M Polyethylene
- Packaging: Plastic bag
- Gross Weight (with packaging): 1kg

- White | ○ REF: JDNHOR030BXNW
- Black | ● REF: JDNHOR030NXNW
- Bronze | ● REF: JDNHOR030ZXNW
- Taupe | ● REF: JDNHOR030KXNW
- Terracota | ● REF: JDNHOR030TXNW
- Anthracite | ● REF: JDNHOR030ANNW

HORTENSIA 30 | CIRCOOLAR

Recycled Multicolour | REF: LUMHOR030BXNLCR

- 17,8 L
- M Recycled detergent cans
- Packaging: Plastic bag
- Gross Weight (with packaging): 1kg

Made of recycled detergent bottles

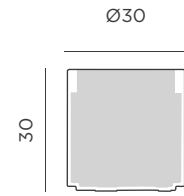

Dimensions (cm)

HORTENSIA 30 | CIRCOOLAR

Recycled Blue | REF: LUMHOR030AZNLCR

- 17,8 L
- M Recycled fishing nets
- Packaging: Plastic bag
- Gross Weight (with packaging): 1kg

Made of recycled fishing nets

LIFT SUPPORT ACCESSORIES | ONLY FOR HORTENSIA 30

SUPPORT ACCESSORY 41cm

- M Lacquered Iron
- Packaging: 29,2 x 36,9 x 2 cm
- Gross Weight (with packaging): 0,67kg

- Black | ● REF: JDNLIFT30041NXNW
- Brass | ● REF: JDNLIFT30041BRNW

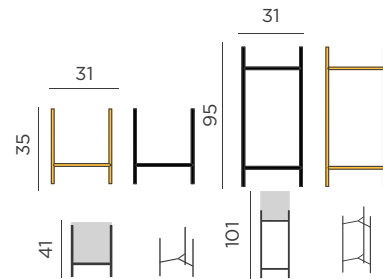

Dimensions (cm)

SUPPORT ACCESSORY 101cm

- M Lacquered Iron
- Packaging: 29,5 x 97 x 2,5 cm
- Gross Weight (with packaging): 1,62kg

- Black | ● REF: JDNLIFT30110NXNW
- Brass | ● REF: JDNLIFT30110BRNW

HORTENSIA 40 HIGH

- 83,4 L
- Includes water reservoir
- M Polyethylene
- Packaging: Plastic bag
- Gross Weight (with packaging): 4kg

- White | ○ REF: JDNHOH040BXNLNW
- Black | ● REF: JDNHOH040NXNLNW
- Bronze | ● REF: JDNHOH040ZXNLNW
- Taupe | ● REF: JDNHOH040KXNLNW
- Terracota | ● REF: JDNHOH040TXNLNW
- Anthracite | ● REF: JDNHOH040ANNLNW

HORTENSIA 40 HIGH | CIRCOOLAR

Recycled Multicolour | REF: LUMHOH040BXNLCR

- 83,4 L
- M Recycled detergent cans
- Packaging: Plastic bag
- Gross Weight (with packaging): 4kg

Made of recycled detergent bottles

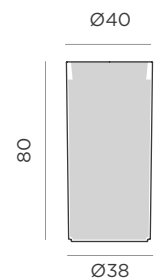

Dimensions (cm)

HORTENSIA 40 HIGH | CIRCOOLAR

Recycled Blue | REF: LUMHOH040AZNLCR

- 83,4 L
- M Recycled fishing nets
- Packaging: Plastic bag
- Gross Weight (with packaging): 4kg

Made of recycled fishing nets

Hortensia Collection.



HORTENSIA 40

- 40 L
- Includes water reservoir
- M Polyethylene
- Packaging: Plastic bag
- Gross Weight (with packaging): 2.5kg

- White | ○ REF: JDNHOR040BXNW
- Black | ● REF: JDNHOR040NXNW
- Bronze | ● REF: JDNHOR040ZXNW
- Taupe | ● REF: JDNHOR040KXNW
- Terracota | ● REF: JDNHOR040TXNW
- Anthracite | ● REF: JDNHOR040ANNW

HORTENSIA 40 | CIRCOOLAR

Recycled Multicolour | REF: LUMHOR040BXNLCR

- 40 L
- M Recycled detergent cans
- Packaging: Plastic bag
- Gross Weight (with packaging): 2.5kg

Made of recycled detergent bottles

HORTENSIA 40 | CIRCOOLAR

Recycled Blue | REF: LUMHOR040AZNLCR

- 40 L
- M Recycled fishing nets
- Packaging: Plastic bag
- Gross Weight (with packaging): 2.5kg

Made of recycled fishing nets

HORTENSIA 50

- 81 L
- Includes water reservoir
- M Polyethylene
- Packaging: Plastic bag
- Gross Weight (with packaging): 4kg

- White | ○ REF: JDNHOR050BXNW
- Black | ● REF: JDNHOR050NXNW
- Bronze | ● REF: JDNHOR050ZXNW
- Taupe | ● REF: JDNHOR050KXNW
- Terracota | ● REF: JDNHOR050TXNW
- Anthracite | ● REF: JDNHOR050ANNW

HORTENSIA 50 | CIRCOOLAR

Recycled Multicolour | REF: LUMHOR050BXNLCR

- 81 L
- M Recycled detergent cans
- Packaging: Plastic bag
- Gross Weight (with packaging): 4kg

Made of recycled detergent bottles

HORTENSIA 50 | CIRCOOLAR

Recycled Blue | REF: LUMHOR050AZNLCR

- 81 L
- M Recycled fishing nets
- Packaging: Plastic bag
- Gross Weight (with packaging): 4kg

Made of recycled fishing nets

HORTENSIA 80 BIG SIZE XXL

- 343 L
- Includes water reservoir
- M Polyethylene
- Packaging: Plastic bag
- Gross Weight (with packaging): 12kg

- White | ○ REF: JDNHOR080BXNW
- Black | ● REF: JDNHOR080NXNW
- Bronze | ● REF: JDNHOR080ZXNW
- Terracota | ● REF: JDNHOR080TXNW
- Anthracite | ● REF: JDNHOR080ANNW

HORTENSIA 80 | CIRCOOLAR

Recycled Multicolour | REF: LUMHOR080BXNLCR

- 343 L
- M Recycled detergent cans
- Packaging: Plastic bag
- Gross Weight (with packaging): 4kg

Made of recycled detergent bottles

HORTENSIA 80 | CIRCOOLAR

Recycled Blue | REF: LUMHOR080AZNLCR

- 343 L
- M Recycled fishing nets
- Packaging: Plastic bag
- Gross Weight (with packaging): 4kg

Made of recycled fishing nets

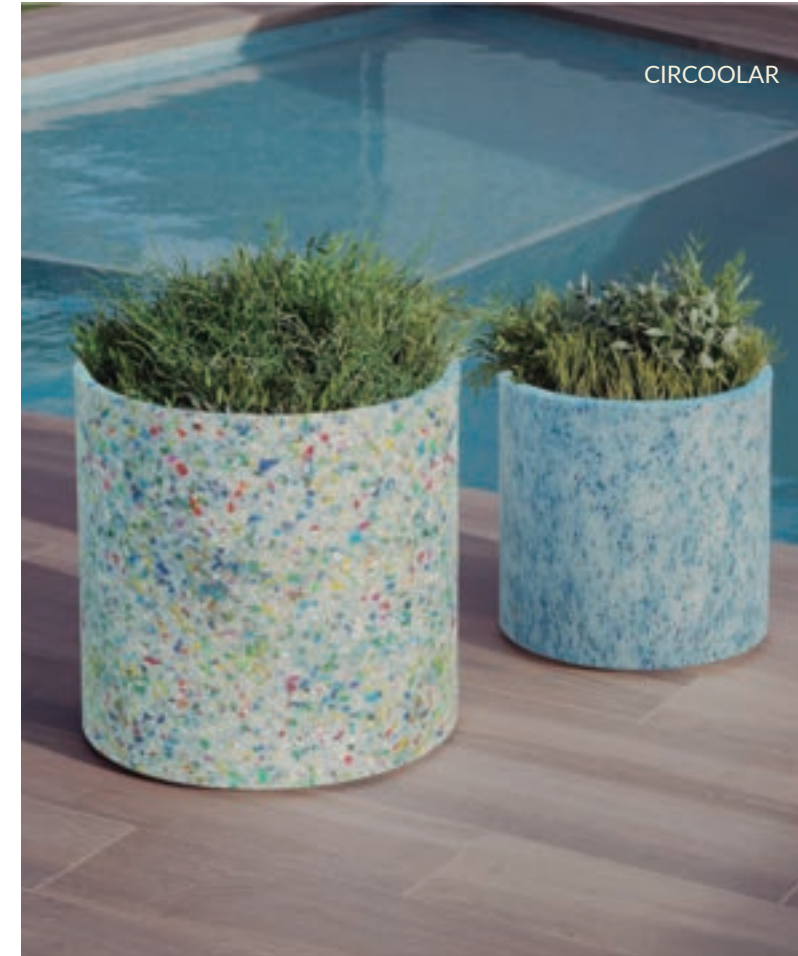
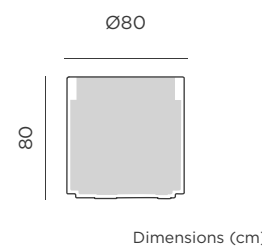
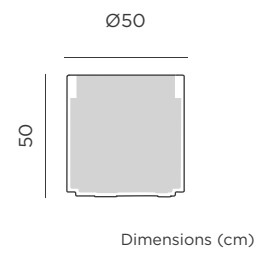
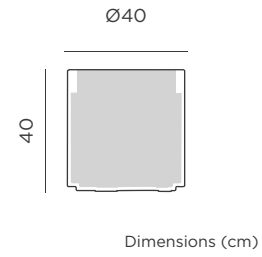

HORTENSIA HIGH

LIFT SUPPORT ACCESSORY

Magnolia 30.

MAGNOLIA 30 | WITH LIGHT

SOLAR & RECHARGEABLE BATTERY

REF: LUMMG030SSNW

- IP65 Outdoor & Indoor use
- Solar + Rechargeable Battery (driver not included)
- Warm Light (included)
- White Light (included)
- RGB Light (included)
- lm 45 lm
- Remote control (included)

- Dimmable
- Twilight sensor
- 3,7 L
- Integrated solar panel
- M** Polyethylene
- Packaging: 32,5 x 32,5 x 33 cm
- Gross Weight (with packaging): 1,7kg

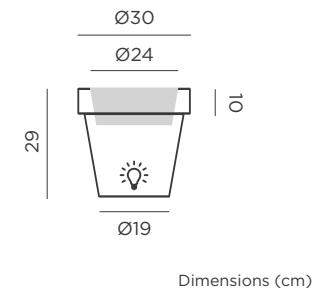

Dimensions (cm)

MAGNOLIA 30 | WITHOUT LIGHT

OPAQUE COLOUR

- 7,9 L
- M** Polyethylene
- Packaging: Plastic bag
- Gross Weight (with packaging): 0,9kg

- White | REF: JDNMG030BXNW
- Black | REF: JDNMG030NXNW
- Bronze | REF: JDNMG030ZXNW
- Anthracite | REF: JDNMG030ANNW

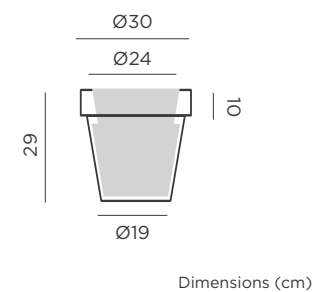

Dimensions (cm)

Magnolia 45.

MAGNOLIA 45 | WITH LIGHT

SOLAR & RECHARGEABLE BATTERY

REF: LUMMG045SSNW

- IP65 Outdoor & Indoor use
- Solar + Rechargeable Battery (driver not included)
- Warm Light (included)
- White Light (included)
- RGB Light (included)
- lm 45 lm
- Remote control (included)

- Dimmable
- Twilight sensor
- 19,4 L
- Integrated solar panel
- M** Polyethylene
- Packaging: 46 x 46 x 46,5 cm
- Gross Weight (with packaging): 4,75kg

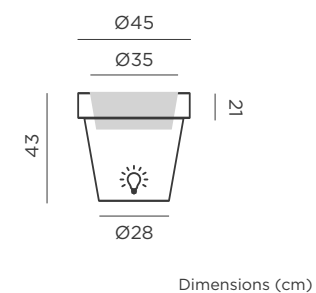

Dimensions (cm)

CABLE

REF: LUMMG045OFNW

- IP65 Outdoor & Indoor use
- White Light (included)
- lm 600 lm
- 19,4 L

- M** Polyethylene
- Packaging: 46 x 46 x 46,5 cm
- Gross Weight (with packaging): 4kg

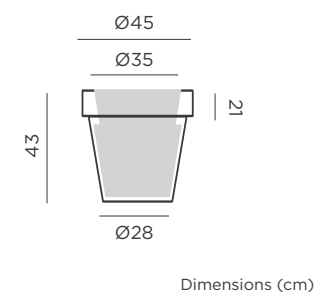

Dimensions (cm)

MAGNOLIA 45 | WITHOUT LIGHT

OPAQUE COLOUR

- 33,4 L
- M** Polyethylene
- Packaging: Plastic bag
- Gross Weight (with packaging): 2kg

- White | REF: JDNMG045BXNW
- Black | REF: JDNMG045NXNW
- Bronze | REF: JDNMG045ZXNW
- Anthracite | REF: JDNMG045ANNW

Magnolia Collection.



Magnolia 60.



Magnolia 80.



MAGNOLIA 60 | WITH LIGHT

SOLAR & RECHARGEABLE BATTERY

REF: LUMMG060SSNW

- IP65 Outdoor & Indoor use
- Solar + Rechargeable Battery (driver not included)
- Warm Light (included)
- White Light (included)
- RGB Light (included)
- lm 45 lm
- Remote control (included)

- Dimmable
- Twilight sensor
- 36,7 L
- Integrated solar panel
- Polyethylene
- Packaging: 59 x 59 x 59 cm
- Gross Weight (with packaging): 7kg

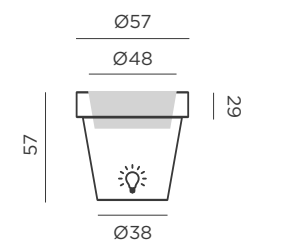

Dimensions (cm)

CABLE

REF: LUMMG060OFNW

- IP65 Outdoor & Indoor use
- White Light (included)
- lm 600 lm
- 36,7 L

- Polyethylene
- Packaging: 59 x 59 x 59 cm
- Gross Weight (with packaging): 7kg

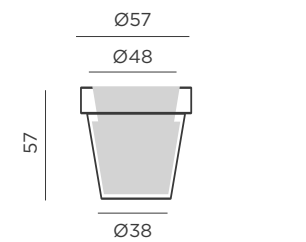

Dimensions (cm)

MAGNOLIA 60 | WITHOUT LIGHT

OPAQUE COLOUR

- 82,3 L
- Polyethylene
- Packaging: Plastic bag
- Gross Weight (with packaging): 5kg

- White | ○ REF: JDNMG060BXNW
- Black | ● REF: JDNMG060XNW
- Bronze | ● REF: JDNMG060ZXNW
- Anthracite | ● REF: JDNMG060ANNW

MAGNOLIA 80 | WITH LIGHT BIG SIZE

SOLAR & RECHARGEABLE BATTERY

REF: JDNMGN080XXSSNW

- IP65 Outdoor & Indoor use
- Solar + Rechargeable Battery (driver not included)
- Warm Light (included)
- White Light (included)
- RGB Light (included)
- lm 600 lm
- Remote control (included)

- Dimmable
- Twilight sensor
- 82,5 L
- Integrated solar panel
- Polyethylene
- Packaging: Plastic bag
- Gross Weight (with packaging): 16kg

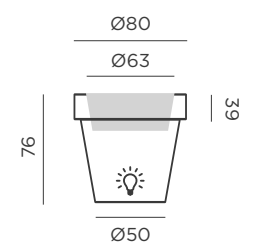

Dimensions (cm)

CABLE

REF: JDNMGN080XXOFNW

- IP65 Outdoor & Indoor use
- White Light (included)
- lm 600 lm
- 82,5 L

- Polyethylene
- Packaging: Plastic bag
- Gross Weight (with packaging): 16kg

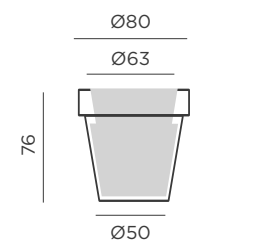

Dimensions (cm)

MAGNOLIA 80 | WITHOUT LIGHT BIG SIZE

OPAQUE COLOUR

- 207 L
- Polyethylene
- Packaging: Plastic bag
- Gross Weight (with packaging): 15kg

- White | ○ REF: JDNMGN080BXNLNW
- Black | ● REF: JDNMGN080XNLNW
- Bronze | ● REF: JDNMGN080ZXNLNW
- Anthracite | ● REF: JDNMGN080ANNLNW



Magnolia 120.



Magnolia 160.

MAGNOLIA 120 | WITH LIGHT BIG SIZE XXL

SOLAR & RECHARGEABLE BATTERY

REF: JDNMGN120XXSSNW

- Outdoor & Indoor use
- Solar + Rechargeable Battery (driver not included)
- Warm Light (included)
- White Light (included)
- RGB Light (included)
- 600 lm
- Remote control (included)

- Dimmable
- Twilight sensor
- 282.2 L
- Integrated solar panel
- Polyethylene
- Packaging: Plastic bag
- Gross Weight (with packaging): 36kg

CABLE

REF: JDNMGN120XXOFNW

- Outdoor & Indoor use
- White Light (included)
- 600 lm
- 282.2 L

- Polyethylene
- Packaging: Plastic bag
- Gross Weight (with packaging): 36kg

MAGNOLIA 120 | WITHOUT LIGHT BIG SIZE XXL

OPAQUE COLOUR

- 752.6 L
- Polyethylene
- Packaging: Plastic bag
- Gross Weight (with packaging): 35kg

- White | **REF: JDNMGN120BXNLNW**
- Black | **REF: JDNMGN120NXNLNW**
- Bronze | **REF: JDNMGN120ZXNLNW**
- Anthracite | **REF: JDNMGN120ANLNLNW**

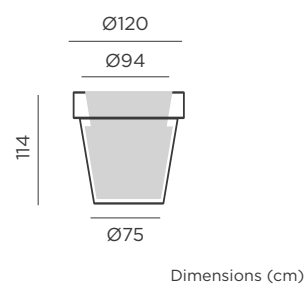
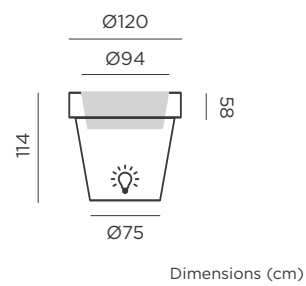

MAGNOLIA 160 | WITH LIGHT BIG SIZE XXL

SOLAR & RECHARGEABLE BATTERY

REF: JDNMGN160XXSSNW

- Outdoor & Indoor use
- Solar + Rechargeable Battery (driver not included)
- Warm Light (included)
- White Light (included)
- RGB Light (included)
- 600 lm
- Remote control (included)

- Dimmable
- Twilight sensor
- 644 L
- Integrated solar panel
- Polyethylene
- Packaging: Plastic bag
- Gross Weight (with packaging): 64kg

CABLE

REF: JDNMGN160XXOFNW

- Outdoor & Indoor use
- White Light (included)
- 600 lm
- 644 L

- Polyethylene
- Packaging: Plastic bag
- Gross Weight (with packaging): 64kg

MAGNOLIA 160 | WITHOUT LIGHT BIG SIZE XXL

OPAQUE COLOUR

- 2000 L
- Polyethylene
- Packaging: Plastic bag
- Gross Weight (with packaging): 64kg

- White | **REF: JDNMGN120BXNW**
- Black | **REF: JDNMGN120NXNW**
- Bronze | **REF: JDNMGN120ZXNW**
- Anthracite | **REF: JDNMGN120ANNW**

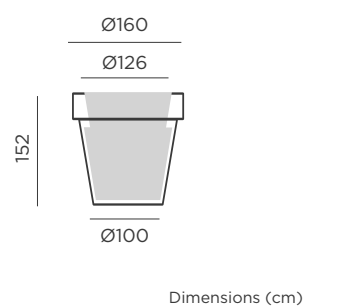
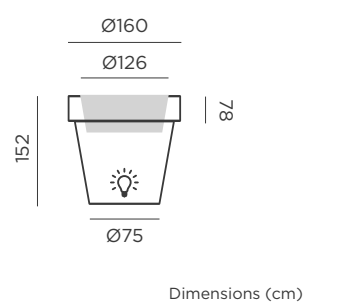

Melisa 30.



Melisa 40.



MELISA 30 | WITH LIGHT

SOLAR & RECHARGEABLE BATTERY

REF: LUMML030SSNW

- IP65 Outdoor & Indoor use
- Solar + Rechargeable Battery (driver not included)
- Warm Light (included)
- White Light (included)
- RGB Light (included)
- Im 45 lm
- Remote control (included)

- Dimmable
- Twilight sensor
- 6,7 L
- Integrated solar panel
- M Polyethylene
- Packaging: 31 x 31 x 62,3 cm
- Gross Weight (with packaging): 4kg

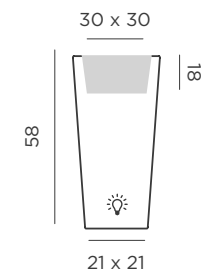

Dimensions (cm)

CABLE

REF: LUMML030OFNW

- IP65 Outdoor & Indoor use
- White Light (included)
- Im 600 lm
- 6,7 L

- M Polyethylene
- Packaging: 31 x 31 x 62,3 cm
- Gross Weight (with packaging): 4kg

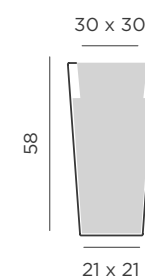

Dimensions (cm)

MELISA 30 | WITHOUT LIGHT

OPAQUE COLOUR

- 11 L
- M Polyethylene
- Packaging: Plastic bag
- Gross Weight (with packaging): 3,5kg

- White | ○ REF: JDNML030BXNW
- Black | ● REF: JDNML030NXNW
- Bronze | ● REF: JDNML030ZXNW
- Taupe | ● REF: JDNML030KXNW
- Terracota | ● REF: JDNML030TNNW
- Anthracite | ● REF: JDNML030ANNW

MELISA 40 | WITH LIGHT

SOLAR & RECHARGEABLE BATTERY

REF: LUMML040SSNW

- IP65 Outdoor & Indoor use
- Solar + Rechargeable Battery (driver not included)
- Warm Light (included)
- White Light (included)
- RGB Light (included)
- Im 45 lm
- Remote control (included)

- Dimmable
- Twilight sensor
- 11,9 L
- Integrated solar panel
- M Polyethylene
- Packaging: 40,5 x 40,5 x 89,5 cm
- Gross Weight (with packaging): 7kg

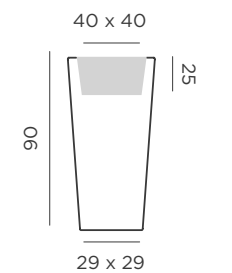

Dimensions (cm)

CABLE

REF: LUMML040OFNW

- IP65 Outdoor & Indoor use
- White Light (included)
- Im 600 lm
- Led tube lighting (included)

- 11,9 L
- M Polyethylene
- Packaging: 40,5 x 40,5 x 89,5 cm
- Gross Weight (with packaging): 7kg

MELISA 40 | WITHOUT LIGHT

OPAQUE COLOUR

- 11,9 L
- M Polyethylene
- Packaging: Plastic bag
- Gross Weight (with packaging): 6kg

- White | ○ REF: JDNML040BXNW
- Black | ● REF: JDNML040NXNW
- Bronze | ● REF: JDNML040ZXNW
- Anthracite | ● REF: JDNML040ANNW



Melisa 50.

MELISA 50 | WITH LIGHT

SOLAR & RECHARGEABLE BATTERY

REF: LUMML050SSNW

- IP65 Outdoor & Indoor use
- Solar + Rechargeable Battery (driver not included)
- Warm Light (included)
- White Light (included)
- RGB Light (included)
- 45 lm
- Remote control (included)

- Dimmable
- Twilight sensor
- 13,9 L
- Integrated solar panel
- Polyethylene
- Packaging: 50 x 50 x 110 cm
- Gross Weight (with packaging): 11kg

CABLE

REF: LUMML0500FNW

- IP65 Outdoor & Indoor use
- White Light (included)
- 600 lm
- Led tube lighting (included)

- 13,9 L
- Polyethylene
- Packaging: 50 x 50 x 111 cm
- Gross Weight (with packaging): 11kg

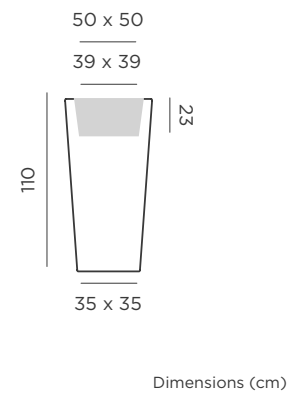

MELISA 50 | WITHOUT LIGHT

OPAQUE COLOUR

- 13,9 L
- Polyethylene
- Packaging: 50 x 50 x 111 cm
- Gross Weight (with packaging): 10kg

- White | **REF: JDNML050BXNW**
- Black | **REF: JDNML050NXNW**
- Bronze | **REF: JDNML050ZXNW**
- Anthracite | **REF: JDNML050ANNW**

Palma.

PALMA 70

SOLAR & RECHARGEABLE BATTERY

REF: LUMPM070SSNW

- IP65 Outdoor & Indoor use
- Solar + Rechargeable Battery (driver not included)
- Warm Light (included)
- White Light (included)
- RGB Light (included)
- 45 lm
- Remote control (included)

- Dimmable
- Twilight sensor
- 9,1 L
- Integrated solar panel
- Polyethylene
- Packaging: 35,5 x 35,5 x 70 cm
- Gross Weight (with packaging): 4,5kg

CABLE

REF: LUMPM0700FNW

- IP65 Outdoor & Indoor use
- White Light (included)
- 600 lm
- 9,1 L

- Polyethylene
- Packaging: 35,5 x 35,5 x 70 cm
- Gross Weight (with packaging): 4,5kg

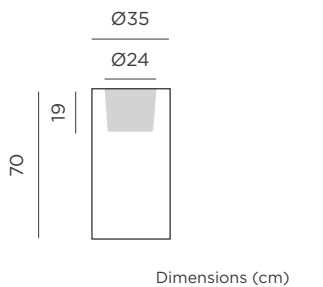



Ficus 60 & Ficus 80

FICUS 60 | WITH LIGHT

SOLAR & RECHARGEABLE BATTERY

REF: LUMFC060SSNW

- IP65 Outdoor & Indoor use
- Solar + Rechargeable Battery (driver not included)
- Warm Light (included)
- White Light (included)
- RGB Light (included)
- lm 45 lm
- Remote control (included)

- Dimmable
- Twilight sensor
- 9 L
- Integrated solar panel
- Polyethylene
- Packaging: 29,4 x 29,4 x 59,5 cm
- Gross Weight (with packaging): 2,98kg

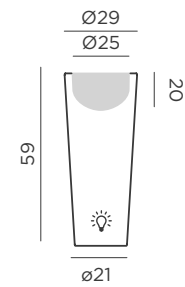

Dimensions (cm)

CABLE

REF: LUMFC060OFNW

- IP65 Outdoor & Indoor use
- White Light (included)
- lm 600 lm
- 9 L

- Polyethylene
- Packaging: 29,4 x 29,4 x 59,5 cm
- Gross Weight (with packaging): 2,6kg

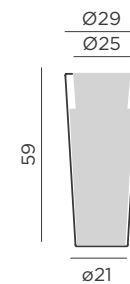

Dimensions (cm)

FICUS 60 | WITHOUT LIGHT

OPAQUE COLOUR

- 16,1 L
- Polyethylene
- Packaging: Plastic bag
- Gross Weight (with packaging): 2,1kg

- White | REF: JDNFC060BXNW
- Black | REF: JDNFC060NXNW
- Bronze | REF: JDNFC060ZXNW
- Anthracite | REF: JDNFC060ANNW

FICUS 80 | WITH LIGHT

SOLAR & RECHARGEABLE BATTERY

REF: LUMFC080SSNW

- IP65 Outdoor & Indoor use
- Solar + Rechargeable Battery (driver not included)
- Warm Light (included)
- White Light (included)
- RGB Light (included)
- lm 45 lm
- Remote control (included)

- Dimmable
- Twilight sensor
- 9,5 L
- Integrated solar panel
- Polyethylene
- Packaging: 29,5 x 29,5 x 80 cm
- Gross Weight (with packaging): 3,2kg

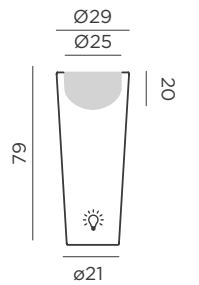

Dimensions (cm)

CABLE

REF: LUMFC080OFNW

- IP65 Outdoor & Indoor use
- White Light (included)
- lm 600 lm
- 9,5 L

- Polyethylene
- Packaging: 29,5 x 29,5 x 80 cm
- Gross Weight (with packaging): 3,2kg

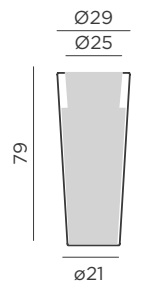

Dimensions (cm)

FICUS 80 | WITHOUT LIGHT

OPAQUE COLOUR

- 22,5 L
- Polyethylene
- Packaging: Plastic bag
- Gross Weight (with packaging): 2,7kg

- White | REF: JDNFC080BXNW
- Black | REF: JDNFC080NXNW
- Bronze | REF: JDNFC080ZXNW
- Anthracite | REF: JDNFC080ANNW



Bambú 70.



Bambú 90.

BAMBU 70 | WITH LIGHT

RECHARGEABLE BATTERY

REF: LUMBM070WLNW

- IP65 Outdoor & Indoor use
- Rechargeable Battery Electric Charge (driver not included)
- White Light (included)
- RGB Light (included)
- 315 lm
- Remote control (included)
- Dimmable

- Led tube lighting (included)
- 15,8 L
- Integrated solar panel
- M Polyethylene
- Packaging: 40 x 40 x 70 cm
- Gross Weight (with packaging): 4,5kg

CABLE

REF: LUMBM0700FNW

- IP65 Outdoor & Indoor use
- White Light (included)
- 600 lm
- 15,8L

- M Polyethylene
- Packaging: 40 x 40 x 70 cm
- Gross Weight (with packaging): 4,5kg

BAMBU 70 | WITHOUT LIGHT

OPAQUE COLOUR

- 15,8 L
- M Polyethylene
- Packaging: 40 x 40 x 70
- Gross Weight (with packaging): 4kg

- White | ○ REF: JDNBM070BXNW
- Black | ● REF: JDNBM070NXNW
- Bronze | ● REF: JDNBM070ZXNW
- Terracota | ● REF: JDNBM070TXNW
- Anthracite | ● REF: JDNBM070ANNW

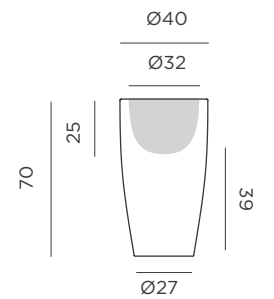

Dimensions (cm)

BAMBU 90 | WITH LIGHT

RECHARGEABLE BATTERY

REF: LUMBM090TWLNW

- IP65 Outdoor & Indoor use
- Rechargeable Battery Electric Charge (driver not included)
- White Light (included)
- RGB Light (included)
- 335 lm
- Remote control (included)
- Dimmable

- Led tube lighting (included)
- 15,8 L
- Integrated solar panel
- M Polyethylene
- Packaging: 40 x 40 x 90 cm
- Gross Weight (with packaging): 6,5kg

CABLE

REF: LUMBM0900FNW

- IP65 Outdoor & Indoor use
- White Light (included)
- 900 lm
- Led tube lighting (included)

- 15,8L
- M Polyethylene
- Packaging: 40 x 40 x 90 cm
- Gross Weight (with packaging): 6,5kg

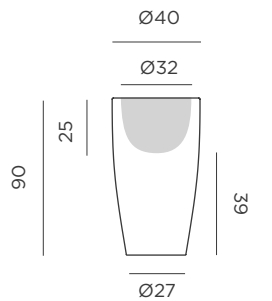

Dimensions (cm)

BAMBU 90 | WITHOUT LIGHT

OPAQUE COLOUR

- 15,8 L
- M Polyethylene
- Packaging: 40 x 40 x 90 cm
- Gross Weight (with packaging): 6kg

- White | ○ REF: JDNBM090BXNW
- Black | ● REF: JDNBM090NXNW
- Bronze | ● REF: JDNBM090ZXNW
- Terracota | ● REF: JDNBM090TXNW
- Anthracite | ● REF: JDNBM090ANNW

Junco.



JUNCO 80 | WITH LIGHT

SOLAR & RECHARGEABLE BATTERY

REF: LUMJN0800SSNW

- IP65 Outdoor & Indoor use
- Solar + Rechargeable Battery (driver not included)
- Warm Light (included)
- White Light (included)
- RGB Light (included)
- 45 lm
- Remote control (included)

- Dimmable
- Twilight sensor
- 38,8 L
- Integrated solar panel
- Polyethylene
- Packaging: 38 x 84 x 82,7cm
- Gross Weight (with packaging): 12kg

CABLE

REF: LUMJN0800FNW

- IP65 Outdoor & Indoor use
- White Light (included)
- 600 lm
- 38,8 L

- Polyethylene
- Packaging: 38 x 84 x 82,7 cm
- Gross Weight (with packaging): 12kg

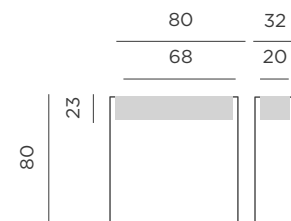

Dimensions (cm)

JUNCO 80 | WITHOUT LIGHT

OPAQUE COLOUR

- 38,8 L
- Polyethylene
- Packaging: Plastic bag
- Gross Weight (with packaging): 10kg

- White | REF: JDNJN080BXNW
- Black | REF: JDNJN080NXNW
- Bronze | REF: JDNJN080ZXNW
- Taupe | REF: JDNJN080KXNW
- Anthracite | REF: JDNJN080ANNW

Jara Collection.



JARA 60X20

- 12,4 L
- Polyethylene
- Packaging: Plastic bag
- Gross Weight (with packaging): 1,5kg

- White | REF: JDNJR060BXNW
- Black | REF: JDNJR060NXNW
- Bronze | REF: JDNJR060ZXNW
- Taupe | REF: JDNJR060KXNW
- Terracota | REF: JDNJR060TXNW
- Anthracite | REF: JDNJR060ANNW

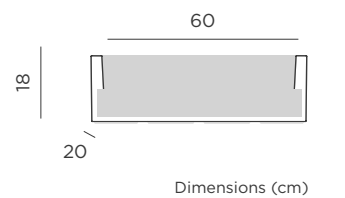

Dimensions (cm)

JARA 100X35

- 51,7 L
- Includes water reservoir
- Polyethylene
- Packaging: Plastic bag
- Gross Weight (with packaging): 7kg

- White | REF: JDNJR100BXNW
- Black | REF: JDNJR100NXNW
- Bronze | REF: JDNJR100ZXNW
- Taupe | REF: JDNJR100KXNW
- Terracota | REF: JDNJR100TXNW
- Anthracite | REF: JDNJR100ANNW

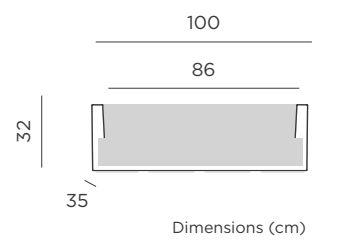

Dimensions (cm)

JARA 100X40

- 60,7 L
- Includes water reservoir
- Polyethylene
- Packaging: Plastic bag
- Gross Weight (with packaging): 8kg

- White | REF: JDNJR140BXNW
- Black | REF: JDNJR140NXNW
- Bronze | REF: JDNJR140ZXNW
- Taupe | REF: JDNJR140KXNW
- Terracota | REF: JDNJR140TXNW
- Anthracite | REF: JDNJR140ANNW

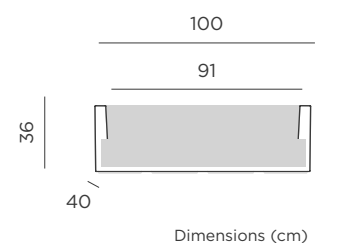

Dimensions (cm)



NARCISO 35



NARCISO 60



NARCISO 50 | 40 | 35

NARCISO 40 | WITH LIGHT

+ **SOLAR & RECHARGEABLE BATTERY**

REF: LUMNCO40SSNW

- Outdoor & Indoor use
- Solar + Rechargeable Battery (driver not included)
- Warm Light (included)
- White Light (included)
- RGB Light (included)
- Im 45 lm
- Remote control (included)

- Dimmable
- Twilight sensor
- 15,3 L
- Integrated solar panel
- Polyethylene
- Packaging: 40,5 x 40,5 x 40 cm
- Gross Weight (with packaging): 3,5kg

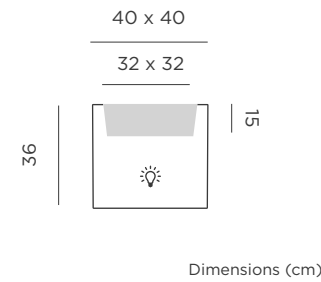

Dimensions (cm)

NARCISO 40 | WITHOUT LIGHT

OPAQUE COLOUR

- 27,8 L
- Includes water reservoir
- Polyethylene
- Packaging: Plastic bag
- Gross Weight (with packaging): 2,5kg

- White | **REF: JDNNC040BXNW**
- Black | **REF: JDNNC040NXNW**
- Bronze | **REF: JDNNC040ZXNW**
- Terracota | **REF: JDNNC040TXNW**
- Anthracite | **REF: JDNNC040ANNW**

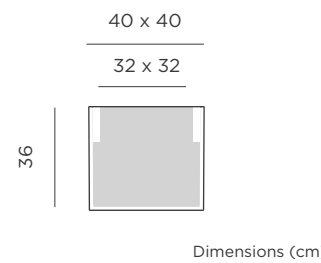

Dimensions (cm)

NARCISO 50 | WITH LIGHT

+ **SOLAR & RECHARGEABLE BATTERY**

REF: LUMNCO50SSNW

- Outdoor & Indoor use
- Solar + Rechargeable Battery (driver not included)
- Warm Light (included)
- White Light (included)
- RGB Light (included)
- Im 45 lm
- Remote control (included)

- Dimmable
- Twilight sensor
- 33 L
- Integrated solar panel
- Polyethylene
- Packaging: 59 x 59 x 59 cm
- Gross Weight (with packaging): 6,5kg

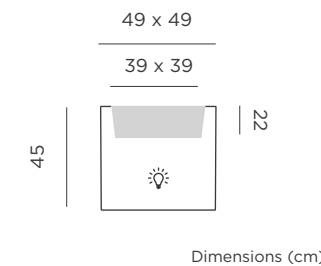

Dimensions (cm)

NARCISO 50 | WITHOUT LIGHT

OPAQUE COLOUR

- 53,8 L
- Includes water reservoir
- Polyethylene
- Packaging: Plastic bag
- Gross Weight (with packaging): 5kg

- White | **REF: JDNNC050BXNW**
- Black | **REF: JDNNC050NXNW**
- Bronze | **REF: JDNNC050ZXNW**
- Terracota | **REF: JDNNC050TXNW**
- Anthracite | **REF: JDNNC050ANNW**

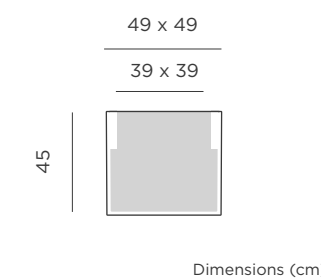

Dimensions (cm)

NARCISO 35

- 17,4 L
- Polyethylene
- Packaging: Plastic bag
- Gross Weight (with packaging): 2kg

- White | **REF: JDNNC035BXNW**
- Black | **REF: JDNNC035NXNW**
- Bronze | **REF: JDNNC035ZXNW**
- Taupe | **REF: JDNNC035KXNW**
- Terracota | **REF: JDNNC035TXNW**
- Anthracite | **REF: JDNNC035ANNW**

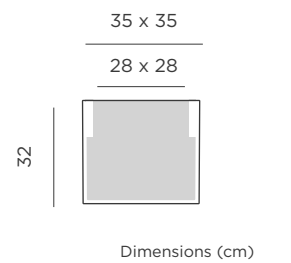

Dimensions (cm)

NARCISO 60

- 84,8 L
- Polyethylene
- Packaging: Plastic bag
- Gross Weight (with packaging): 7kg

- White | **REF: JDNNC060BXNW**
- Black | **REF: JDNNC060NXNW**
- Bronze | **REF: JDNNC060ZXNW**
- Anthracite | **REF: JDNNC060ANNW**

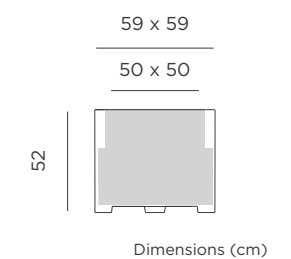

Dimensions (cm)

Gerbera.

GERBERA 33



GERBERA 50



GERBERA 45

GERBERA 33

- 🍷 19,6 L
- 🌊 Includes water reservoir
- M** Polyethylene
- 📦 Packaging: Plastic bag
- 📦 Gross Weight (with packaging): 1,2kg

- White | ○ **REF: JDNGBO33BXNW**
- Black | ● **REF: JDNGBO33NXNW**
- Bronze | ● **REF: JDNGBO33ZXNW**
- Taupe | ● **REF: JDNGBO33KXNW**
- Terracota | ● **REF: JDNGBO33TXNW**
- Anthracite | ● **REF: JDNGBO33ANNW**

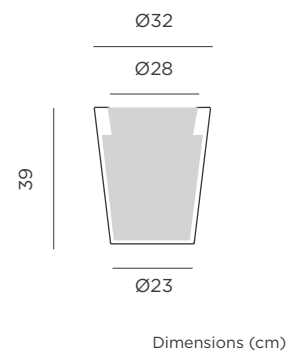

GERBERA 45

- 🍷 54,8 L
- 🌊 Includes water reservoir
- M** Polyethylene
- 📦 Packaging: Plastic bag
- 📦 Gross Weight (with packaging): 2,5kg

- White | ○ **REF: JDNGBO45BXNW**
- Black | ● **REF: JDNGBO45NXNW**
- Bronze | ● **REF: JDNGBO45ZXNW**
- Taupe | ● **REF: JDNGBO45KXNW**
- Terracota | ● **REF: JDNGBO45TXNW**
- Anthracite | ● **REF: JDNGBO45ANNW**

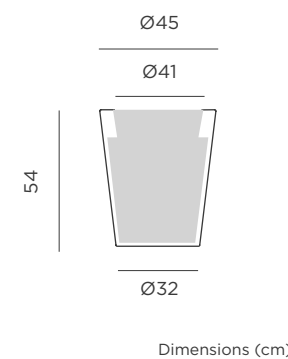

GERBERA 50 | RUSTIC TEXTURE

- 🍷 72,8 L
- 🌊 Includes water reservoir
- M** Polyethylene
- 📦 Packaging: Plastic bag
- 📦 Gross Weight (with packaging): 4kg

- White | ○ **REF: JDNGBO50BXNW**
- Black | ● **REF: JDNGBO50NXNW**
- Bronze | ● **REF: JDNGBO50ZXNW**
- Terracota | ● **REF: JDNGBO50TXNW**
- Anthracite | ● **REF: JDNGBO50ANNW**

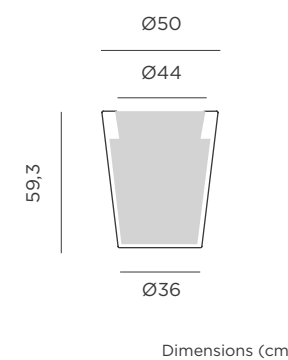

Camelia Collection.



Camelia 40.



Camelia 60.

CAMELIA 40 | WITH LIGHT

SOLAR & RECHARGEABLE BATTERY

REF: LUMCA040SSNW

- IP65 Outdoor & Indoor use
- Rechargeable Battery Electric Charge (driver not included)
- Warm Light (included)
- White Light (included)
- RGB Light (included)
- Im 45 lm
- Remote control (included)

- Dimmable
- Twilight sensor
- 5,5 L
- Integrated solar panel
- M** Polyethylene
- Packaging: 40,5 x 40,5 x 39,5 cm
- Gross Weight (with packaging): 3,5kg

CABLE

REF: LUMCA040OFNW

- IP65 Outdoor & Indoor use
- White Light (included)
- Im 600 lm
- 5,5 L

- M** Polyethylene
- Packaging: 40,5 x 40,5 x 39,5 cm
- Gross Weight (with packaging): 3,2kg

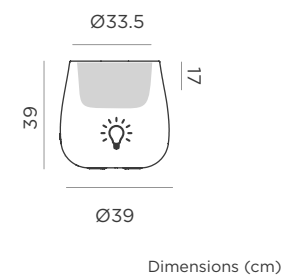

CAMELIA 40 | WITHOUT LIGHT

OPAQUE COLOUR

- 32,45 L
- M** Polyethylene
- Packaging: Plastic bag
- Gross Weight (with packaging): 2,2kg

- White | REF: JDNCA040BXNW
- Black | REF: JDNCA040NXNW
- Bronze | REF: JDNCA040ZXNW
- Anthracite | REF: JDNCA040ANNW

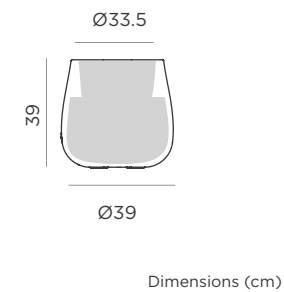

CAMELIA 40 | CIRCOOLAR

Recycled Multicolour | REF: LUMCML040BXNLCR

- 32,45 L
- M** Recycled detergent bottles
- Packaging: Plastic bag
- Gross Weight (with packaging): 2,2kg

Made of recycled detergent bottles

CAMELIA 40 | CIRCOOLAR

Recycled Blue | REF: LUMCML040AZNLCR

- 32,45 L
- M** Recycled fishing nets
- Packaging: Plastic bag
- Gross Weight (with packaging): 2,2kg

Made of recycled fishing nets

CAMELIA 60 | WITH LIGHT

SOLAR & RECHARGEABLE BATTERY

REF: LUMCA060SSNW

- IP65 Outdoor & Indoor use
- Solar + Rechargeable Battery (driver not included)
- Warm Light (included)
- White Light (included)
- RGB Light (included)
- Im 45 lm
- Remote control (included)

- Dimmable
- Twilight sensor
- 29,4 L
- Integrated solar panel
- M** Polyethylene
- Packaging: 60,5 x 60,5 x 42,7 cm
- Gross Weight (with packaging): 5kg

CABLE

REF: LUMCA060OFNW

- IP65 Outdoor & Indoor use
- White Light (included)
- Im 600 lm
- 29,4 L

- M** Polyethylene
- Packaging: 60 x 60 x 42 cm
- Gross Weight (with packaging): 5kg

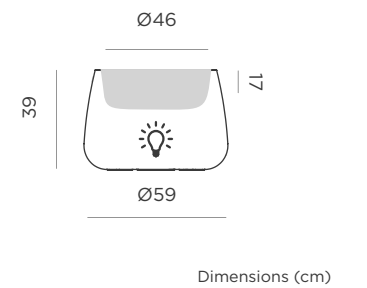

CAMELIA 60 | WITHOUT LIGHT

OPAQUE COLOUR

- 74 L
- M** Polyethylene
- Packaging: Plastic bag
- Gross Weight (with packaging): 4,5kg

- White | REF: JDNCA060BXNW
- Black | REF: JDNCA060NXNW
- Bronze | REF: JDNCA060ZXNW
- Anthracite | REF: JDNCA060ANNW

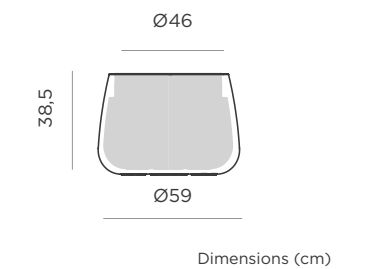

CAMELIA 60 | CIRCOOLAR

Recycled Multicolour | REF: LUMCML060BXNLCR

- 74 L
- M** Recycled detergent bottles
- Packaging: Plastic bag
- Gross Weight (with packaging): 4,5kg

Made of recycled detergent bottles

CAMELIA 60 | CIRCOOLAR

Recycled Blue | REF: LUMCML060AZNLCR

- 74 L
- M** Recycled fishing nets
- Packaging: Plastic bag
- Gross Weight (with packaging): 4,5kg

Made of recycled fishing nets



Camelia 80.



Camelia large.

CAMELIA 80 | WITH LIGHT

SOLAR & RECHARGEABLE BATTERY

REF: LUMCA080SSNW

- Outdoor & Indoor use
- Solar + Rechargeable Battery (driver not included)
- Warm Light (included)
- White Light (included)
- RGB Light (included)
- 45 lm
- Remote control (included)

- Dimmable
- Twilight sensor
- 74,8 L
- Integrated solar panel
- Polyethylene
- Packaging: Plastic bag
- Gross Weight (with packaging): 10,5kg

CABLE

REF: LUMCA080OFNW

- Outdoor & Indoor use
- White Light (included)
- 600 lm
- 74,8 L

- Polyethylene
- Packaging: Plastic bag
- Gross Weight (with packaging): 10,5kg

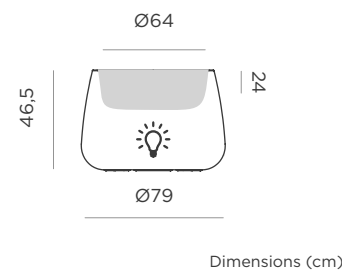

CAMELIA 80 | WITHOUT LIGHT

OPAQUE COLOUR

- 178,4 L
- Polyethylene
- Packaging: Plastic bag
- Gross Weight (with packaging): 10kg

- White | **REF: JDNCA080BXNW**
- Black | **REF: JDNCA080NXNW**
- Bronze | **REF: JDNCA080ZXNW**
- Anthracite | **REF: JDNCA080ANNW**

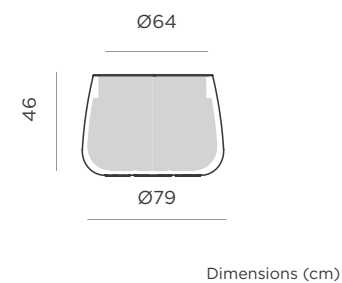

CAMELIA 80 | CIRCOOLAR

Recycled Multicolour | **REF: LUMCML080BXNLCR**

- 178,4 L
- Recycled detergent bottles
- Packaging: Plastic bag
- Gross Weight (with packaging): 10kg

Made of recycled detergent bottles

CAMELIA 80 | CIRCOOLAR

Recycled Blue | **REF: LUMCML080AZNLCR**

- 178,4 L
- Recycled fishing nets
- Packaging: Plastic bag
- Gross Weight (with packaging): 10kg

Made of recycled fishing nets

CAMELIA LARGE | WITH LIGHT

SOLAR & RECHARGEABLE BATTERY

REF: LUMCALARSSNW

- Outdoor & Indoor use
- Solar + Rechargeable Battery (driver not included)
- Warm Light (included)
- White Light (included)
- RGB Light (included)
- 45 lm
- Remote control (included)

- Dimmable
- Twilight sensor
- 43,4 L
- Integrated solar panel
- Polyethylene
- Packaging: 50 x 111 x 50 cm
- Gross Weight (with packaging): 7,5kg

CABLE

REF: LUMCALAROFNW

- Outdoor & Indoor use
- White Light (included)
- 600 lm
- 43,4 L

- Polyethylene
- Packaging: 50 x 111 X 50 cm
- Gross Weight (with packaging): 7,5kg

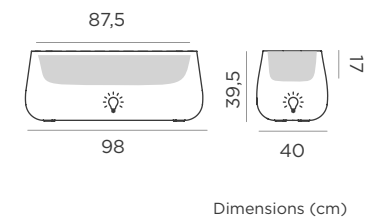

CAMELIA LARGE | WITHOUT LIGHT

OPAQUE COLOUR

- 101,6 L
- Polyethylene
- Packaging: Plastic bag
- Gross Weight (with packaging): 6kg

- White | **REF: JDNCALARBXNW**
- Black | **REF: JDNCALARNXNW**
- Bronze | **REF: JDNCALARZXNW**
- Anthracite | **REF: JDNCALARANNW**

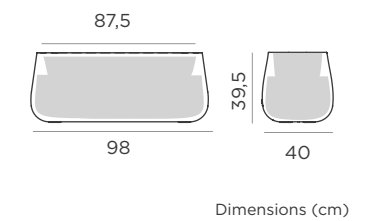

CAMELIA LARGE | CIRCOOLAR

Recycled Multicolour | **REF: LUMCLG100BXNLCR**

- 101,6 L
- Recycled detergent bottles
- Packaging: Plastic bag
- Gross Weight (with packaging): 6kg

Made of recycled detergent bottles

CAMELIA LARGE | CIRCOOLAR

Recycled Blue | **REF: LUMCLG100AZNLCR**

- 101,6 L
- Recycled fishing nets
- Packaging: Plastic bag
- Gross Weight (with packaging): 6kg

Made of recycled fishing nets



Camelia high.

CAMELIA HIGH | WITH LIGHT

SOLAR & RECHARGEABLE BATTERY

REF: LUMCAHIGSSNW

- IP65 Outdoor & Indoor use
- Solar + Rechargeable Battery (driver not included)
- Warm Light (included)
- White Light (included)
- RGB Light (included)
- Im 45 lm
- Remote control (included)

- Dimmable
- Twilight sensor
- 14 L
- Integrated solar panel
- Polyethylene
- Packaging: 40,5 x 40,5 x 69,5 cm
- Gross Weight (with packaging): 4kg

CABLE

REF: LUMCAHIGOFNW

- IP65 Outdoor & Indoor use
- White Light (included)
- Im 600 lm
- 14 L

- Polyethylene
- Packaging: Plastic bag
- Gross Weight (with packaging): 4kg

CAMELIA HIGH | WITHOUT LIGHT

OPAQUE COLOUR

- 53.7 L
- Polyethylene
- Packaging: Plastic bag
- Gross Weight (with packaging): 3,5kg

- White | REF: JDNCAHIGBXNW
- Black | REF: JDNCAHIGNXNW
- Bronze | REF: JDNCAHIGZXNW
- Anthracite | REF: JDNCAHIGANNW

CAMELIA HIGH | CIRCOOLAR

Recycled Multicolour | REF: LUMCMH040BXNLCR

- 53.7 L
- Recycled detergent bottles
- Packaging: Plastic bag
- Gross Weight (with packaging): 3,5kg

Made of recycled detergent bottles

CAMELIA HIGH | CIRCOOLAR

Recycled Blue | REF: LUMCMH040AZNLCR

- 53.7 L
- Recycled fishing nets
- Packaging: Plastic bag
- Gross Weight (with packaging): 3,5kg

Made of recycled fishing nets

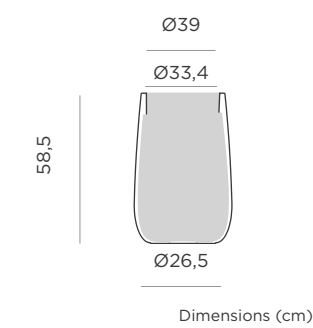
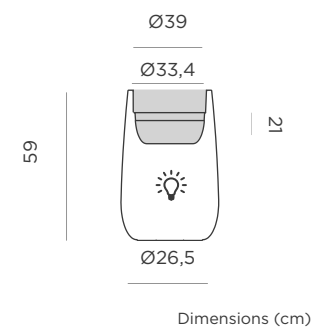

Jazmín.



JAZMÍN 60

- 🌿 21,5 L
- 🚰 Includes water reservoir
- M** Polyethylene
- 📦 Packaging: Plastic bag
- 📦 Gross Weight (with packaging): 2kg

- White | ○ REF: JDNJZ060BXNW
- Black | ● REF: JDNJZ060NXNW
- Bronze | ● REF: JDNJZ060ZXNW
- Terracota | ● REF: JDNJZ060TXNW
- Anthracite | ● REF: JDNJZ060ANNW

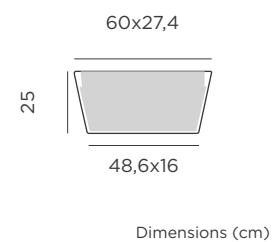

JAZMÍN 80

- 🌿 58,7 L
- 🚰 Includes water reservoir | Plate included
- M** Polyethylene
- 📦 Packaging: Plastic bag
- 📦 Gross Weight (with packaging): 4kg

- White | ○ REF: JDNJZ080BXNW
- Black | ● REF: JDNJZ080NXNW
- Bronze | ● REF: JDNJZ080ZXNW
- Terracota | ● REF: JDNJZ080TXNW
- Anthracite | ● REF: JDNJZ080ANNW

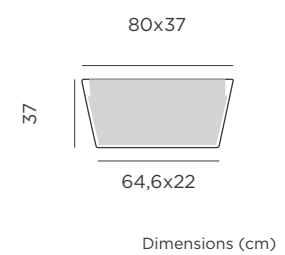

Clavel.



CLAVEL 30

- 🌿 5,2 L
- M** Polyethylene
- 📦 Packaging: Plastic bag
- 📦 Gross Weight (with packaging): 1,2kg

- White | ○ REF: JDNCV030BXNW
- Black | ● REF: JDNCV030NXNW
- Bronze | ● REF: JDNCV030ZXNW
- Taupe | ● REF: JDNCV030KXNW
- Terracota | ● REF: JDNCV030TXNW
- Anthracite | ● REF: JDNCV030ANNW

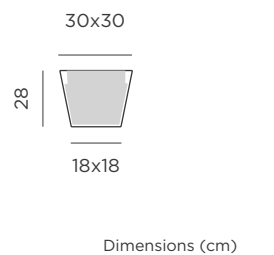

CLAVEL 40

- 🌿 12,3 L
- M** Polyethylene
- 📦 Packaging: Plastic bag
- 📦 Gross Weight (with packaging): 2,5kg

- White | ○ REF: JDNCV040BXNW
- Black | ● REF: JDNCV040NXNW
- Bronze | ● REF: JDNCV040ZXNW
- Terracota | ● REF: JDNCV040TXNW
- Anthracite | ● REF: JDNCV040ANNW

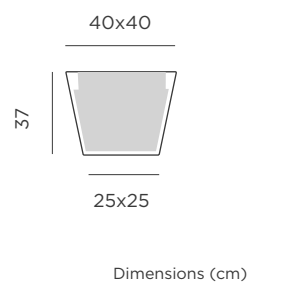

VIOLETA 30

- 12,5 L
- Includes water reservoir
- M Polyethylene
- Packaging: Plastic bag
- Gross Weight (with packaging): 1kg

- White | ○ REF: JDNVLO30BXNW
- Black | ● REF: JDNVLO30NXNW
- Bronze | ● REF: JDNVLO30ZXNW
- Taupe | ● REF: JDNVLO30KXNW
- Terracota | ● REF: JDNVLO30TXNW
- Anthracite | ● REF: JDNVLO30ANNW

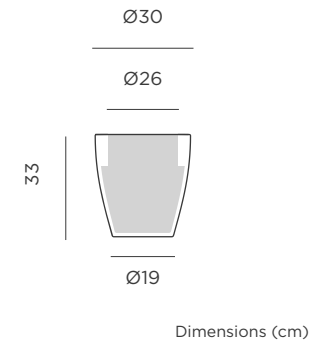

VIOLETA 40 | WITH LIGHT

SOLAR & RECHARGEABLE BATTERY

REF: LUMVLO40SSNW

- IP65 Outdoor & Indoor use
- Solar + Rechargeable Battery (driver not included)
- Warm Light (included)
- White Light (included)
- RGB Light (included)
- Im 45 lm
- Remote control (included)

- Dimmable
- Twilight sensor
- 14,5 L
- Integrated solar panel
- M Polyethylene
- Packaging: 46 x 46 x 46,5 cm
- Gross Weight (with packaging): 3kg

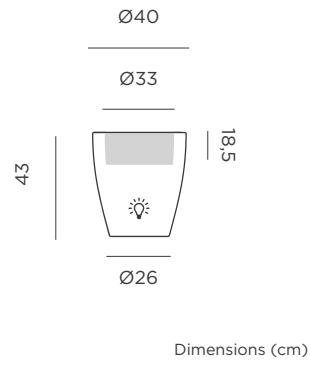

VIOLETA 40 | WITHOUT LIGHT

OPAQUE COLOUR

- 30,6 L
- Includes water reservoir
- M Polyethylene
- Packaging: Plastic bag
- Gross Weight (with packaging): 2kg

- White | ○ REF: JDNVLO40BXNW
- Black | ● REF: JDNVLO40NXNW
- Bronze | ● REF: JDNVLO40ZXNW
- Taupe | ● REF: JDNVLO40KXNW
- Terracota | ● REF: JDNVLO40TXNW
- Anthracite | ● REF: JDNVLO40ANNW

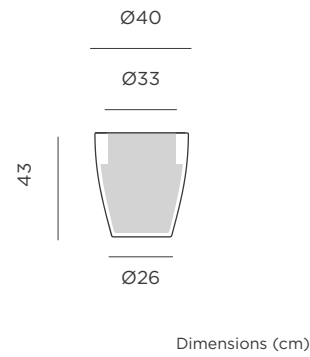

VIOLETA 55 | WITH LIGHT

SOLAR & RECHARGEABLE BATTERY

REF: LUMVLO55SSNW

- IP65 Outdoor & Indoor use
- Rechargeable Battery Electric Charge (driver not included)
- Warm Light (included)
- White Light (included)
- RGB Light (included)
- Im 45 lm
- Remote control (included)

- Dimmable
- Twilight sensor
- 34,7 L
- Integrated solar panel
- M Polyethylene
- Packaging: 59 x 59 x 59 cm
- Gross Weight (with packaging): 5,5kg

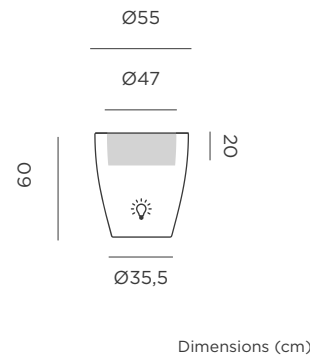

VIOLETA 55 | WITHOUT LIGHT

OPAQUE COLOUR

- 68,2 L
- Includes water reservoir
- M Polyethylene
- Packaging: Plastic bag
- Gross Weight (with packaging): 4kg

- White | ○ REF: JDNVLO55BXNW
- Black | ● REF: JDNVLO55NXNW
- Bronze | ● REF: JDNVLO55ZXNW
- Terracota | ● REF: JDNVLO55TXNW
- Anthracite | ● REF: JDNVLO55ANNW

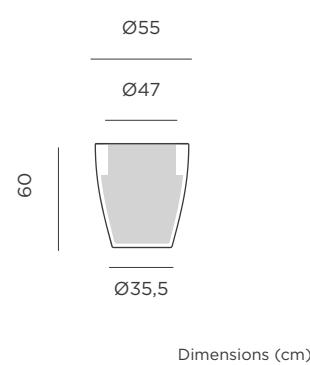

Violeta.



VIOLETA 55 | 40 | 30

Girasol.



GIRASOL BIG SIZE

- 🍷 313 L
- M** Polyethylene
- 📦 Packaging: Plastic bag
- 📦 Gross Weight (with packaging): 14kg

- White | ○ REF: JDNGLO90BXNW
- Black | ● REF: JDNGLO90NXNW
- Bronze | ● REF: JDNGLO90ZXNW
- Terracota | ● REF: JDNGLO90TXNW
- Anthracite | ● REF: JDNGLO90ANNW

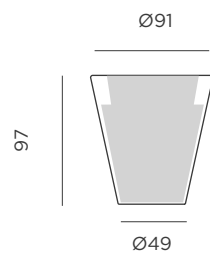

Dimensions (cm)

Caléndula.



CALÉNDULA RÚSTICA

- 🍷 49,7 L
- M** Polyethylene
- 📦 Packaging: Plastic bag
- 📦 Gross Weight (with packaging): 6kg

- White | ○ REF: JDNCL050BXNW
- Black | ● REF: JDNCL050NXNW
- Bronze | ● REF: JDNCL050ZXNW
- Terracota | ● REF: JDNCL050TXNW
- Anthracite | ● REF: JDNCL050ANNW

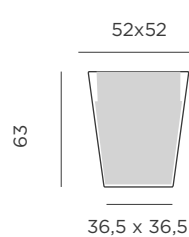

Dimensions (cm)

Camomila.



CAMOMILA RÚSTICA

- 44 L
- M Polyethylene
- Packaging: Plastic bag
- Gross Weight (with packaging): 2,5kg

- White | ○ REF: JDNCM040BXNW
- Black | ● REF: JDNCM040NXNW
- Bronze | ● REF: JDNCM040ZXNW
- Taupe | ● REF: JDNCM040KXNW
- Terracota | ● REF: JDNCM040TXNW
- Anthracite | ● REF: JDNCM040ANNW



Dimensions (cm)

Petunia.



PETUNIA RÚSTICA

- 17,3 L
- M Polyethylene
- Packaging: Plastic bag
- Gross Weight (with packaging): 1kg

- White | ○ REF: JDNPT036BXNW
- Black | ● REF: JDNPT036NXNW
- Bronze | ● REF: JDNPT036ZXNW
- Taupe | ● REF: JDNPT036KXNW
- Terracota | ● REF: JDNPT036TXNW
- Anthracite | ● REF: JDNPT036ANNW

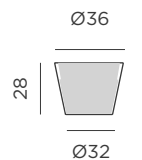

Dimensions (cm)

Rosa.

ROSA 45

- 🍷 26 L
- M** Polyethylene
- 📦 Packaging: Plastic bag
- 📦 Gross Weight (with packaging): 1.5kg

- White | ○ **REF: JDNRS045BXNW**
- Black | ● **REF: JDNRS045NXNW**
- Bronze | ● **REF: JDNRS045ZXNW**
- Terracota | ● **REF: JDNRS045TXNW**
- Anthracite | ● **REF: JDNRS045ANNW**

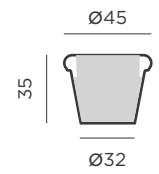

Dimensions (cm)

ROSA 55

- 🍷 42.8 L
- M** Polyethylene
- 📦 Packaging: Plastic bag
- 📦 Gross Weight (with packaging): 2.3kg

- White | ○ **REF: JDNRS055BXNW**
- Black | ● **REF: JDNRS055NXNW**
- Bronze | ● **REF: JDNRS055ZXNW**
- Terracota | ● **REF: JDNRS055TXNW**
- Anthracite | ● **REF: JDNRS055ANNW**

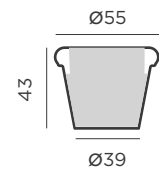

Dimensions (cm)

ROSA 65

- 🍷 79 L
- M** Polyethylene
- 📦 Packaging: Plastic bag
- 📦 Gross Weight (with packaging): 3kg

- White | ○ **REF: JDNRS065BXNW**
- Black | ● **REF: JDNRS065NXNW**
- Bronze | ● **REF: JDNRS065ZXNW**
- Terracota | ● **REF: JDNRS065TXNW**
- Anthracite | ● **REF: JDNRS065ANNW**

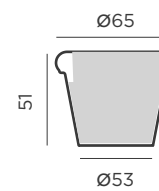

Dimensions (cm)

ROSA 75

- 🍷 121 L
- M** Polyethylene
- 📦 Packaging: Plastic bag
- 📦 Gross Weight (with packaging): 5kg

- White | ○ **REF: JDNRS075BXNW**
- Black | ● **REF: JDNRS075NXNW**
- Bronze | ● **REF: JDNRS075ZXNW**
- Tpe | ● **REF: JDNRS075KXNW**
- Terracota | ● **REF: JDNRS075TXNW**
- Anthracite | ● **REF: JDNRS075ANNW**

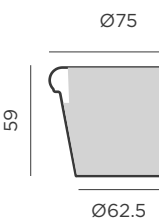

Dimensions (cm)



Plates.

ROUNDED PLATE 30

Compatible with: Violeta 40, Magnolia 45, Rosa 45, Bambú 90, Petunia 30, Hortensia 30, Ficus 60, Ficus 80.

- REF: JDNPRO30BXNW
- REF: JDNPRO30XNW
- REF: JDNPRO30ZXNW
- REF: JDNPRO30KXNW
- REF: JDNPRO30TXNW
- REF: JDNPRO30ANNW

31.5x31.5

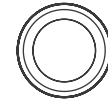

Ø37

Dimensions (cm)

ROUNDED PLATE 40

Compatible with: Violeta 55, Magnolia 60, Rosa 55, Gerbera 45, Azalea 50, Hortensia 40, Hortensia 40 High.

- REF: JDNPRO40BXNW
- REF: JDNPRO40XNW
- REF: JDNPRO40ZXNW
- REF: JDNPRO40KXNW
- REF: JDNPRO40TXNW
- REF: JDNPRO40ANNW

41x41

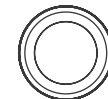

Ø49

Dimensions (cm)

SQUARED PLATE 40

Compatible with: Caléndula 50, Melisa 50, Narciso 35.

- REF: JDNPC040BXNW
- REF: JDNPC040XNW
- REF: JDNPC040ZXNW
- REF: JDNPC040KXNW
- REF: JDNPC040TXNW
- REF: JDNPC040ANNW

40x40

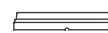

47x47

Dimensions (cm)

SQUARED PLATE 50

Compatible with: Narciso 50.

- REF: JDNPC050BXNW
- REF: JDNPC050XNW
- REF: JDNPC050ZXNW
- REF: JDNPC050KXNW
- REF: JDNPC050TXNW
- REF: JDNPC050ANNW

52x52

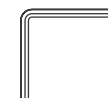
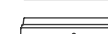

































61.5x61.5

Dimensions (cm)



Glossary.

White light (included) 	 Artificial plants included
Warm light (included) 	 Cherry bulb included
RGB light (included) 	 Solar panel
Led tube Lighting 	 String
Flame effect led light 	lm Lumens
Remote control 	 Packaging
Dimmable 	 Weight
Touch control 	 Solar + electric charge
Twilight sensor 	 Electric charge
Motion sensor 	 Solar charge
Hanging product 	 AAA bateries
Play music 	 Hardwire
Integrated speaker 	 Cable
Main Material 	 Jute Cable
Floating, not submersible 	 Magnetic
Floating & submersible 	 Connectable
Planter volume 	IP Indicates the level of protection of the electrical or electronic equipment against the entry of external agents: dust or water
Includes water reservoir 	

Polyethylene Textures.

Newgarden's products made of polyethylene have a visually smooth and softly granulated finish that is very pleasant to the touch.

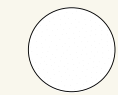

SMOOTH TEXTURE
Polyethylene

The rustic finish can be found in a very specific selection of flowerpots.



RUSTIC TEXTURE
Polyethylene

Colours & Finishes.

TRANSLUCENT POLYETHYLENE & ABS



WHITE
Polyethylene



LIME
Polyethylene



RECYCLED BLUE
Recycled fishing nets



RECYCLED MULTICOLOUR
Recycled detergent bottles

OPAQUE POLYETHYLENE



WHITE
Polyethylene



BLACK
Polyethylene



BRONZE
Polyethylene

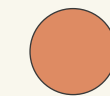

TERRACOTTA
Polyethylene



TAUPE
Polyethylene



ANTHRACITE
Polyethylene

OTHER MATERIALS

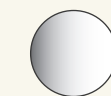

OPAQUE GLOSSY WHITE
ABS



OPAQUE GLOSSY BLACK
ABS

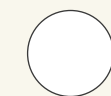

OPAQUE WHITE
Metal



OPAQUE MINT
Metal



OPAQUE BRASS
Metal

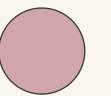

OPAQUE ROSE GOLD
Metal



OPAQUE LIME
Metal



OPAQUE WOOD EFFECT
Metal



OPAQUE GREY
ABS



OPAQUE SPACE GREY
Metal



OPAQUE BEIGE
ABS



OPAQUE ANTHRACITE
Metal

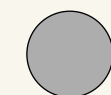

OPAQUE TAUPE GREY
RECYCLED PVC

Certain products may feature a blend of various materials, and in such instances, we will identify and highlight the predominant material in the product.

(*) To ensure optimal maintenance, it is essential to shield these items from rain, direct sunlight, and abrupt temperature changes. Natural materials such as bamboo, rattan, beechwood, or seaweed may undergo color changes or develop cracks over time. When exposed to natural elements, it is advisable to regularly apply a suitable oil or varnish for each specific material. This not only extends protection against rain and UVA rays but also enhances the product's longevity. For cleaning, use a cloth or a brush to eliminate dust, and gently rub with a slightly moistened sponge.

Use according to IP.

Here you can find information about the possible uses of Newgarden's products according to their IP (index of protection of the electrical or electronic system against external agents)

IP20

Newgarden's products with IP20 can only be used indoors, the electrical system, switches or cables must be protected from direct contact with water. Note that, although the product is made of Polyethylene, which is resistant to external agents, the electrical system is designed for **indoor use only**.



IP43

Newgarden's products with IP 43 / 44 can be used outdoors, it is protected against dust and weak and very moderate rain. **If this product also have accessories made of natural fibres, wood or metal parts, it is advisable to protect it from direct contact with water and humidity.** Store it in a dry place after use. In the event of rain or very adverse weather conditions, it should be protected from these external agents to avoid future problems.



IP44

IP54

Newgarden's products with IP 54 **can be used outdoors, as they are protected against dust and light rain.** If this product also has accessories made of natural fibres, wood or metal parts, it is advisable to protect it from direct contact with water and humidity. Store it in a dry place after use. In case of rain or very adverse weather conditions it must be protected from these external agents to avoid future problems.



IP65

Newgarden's products with IP65 **can be used outdoors, they are airtight against dust and rain.** If this product also has accessories made of natural fibres, wood or metal parts, it is advisable to protect it from direct contact with water and humidity. Store it in a dry place after use. In case of rain or very adverse weather conditions it must be protected from these external agents to avoid future problems.



IP67

Newgarden products with IP67 are dust-tight and rainproof. They are also floating (submersion is not recommended) so they can be used in swimming pools. They must be protected against very adverse weather conditions.



IP68

Newgarden products with IP68 are dust-tight and rainproof. They are also floating and submersible (according to each product's own instructions for use) so they can be used in swimming pools. They must be protected against very adverse weather conditions.



The possible differences between the original color, illumination and color captured are due to the printing technique.

NEWGARDEN reserves the right over photographs and designs made, so it is forbidden the manufacture, distribution and / or marketing of the products shown on any media.

NEWGARDEN reserves the right to modify, in whole or in part, without prior notice, any information or technical specification of this publication.

All the information that appears in this catalog in terms of dimensions and capacity are approximate and are susceptible to variations due to improvements in the production process.

#BeHappy

@ Copyright. 2024. Newgarden Spain.

All rights reserved

**Avenida de Francia, 5-15 30840
Alhama de Murcia. Murcia (Spain)
info@newgarden.es
www.newgarden.es
T. +34 968978806**